

Grove TMS800E

Product Guide



Features

- 12,6 m - 39 m (41 ft - 128 ft) four-section full power MEGAFORM™ boom
- 10 m – 17 m (33 ft – 56 ft) manual offset bifold swingaway
- 2 x 20 ft intermediate lattice inserts
- 10 886 kg (24,000 lb) counterweight with hydraulic removal system
- Cummins QSM 402, six-cylinder after cooled 300 kW (402 hp) engine
- Front and rear air ride suspension

Features



MEGAFORM™ boom

The Grove MEGAFORM™ boom shape eliminates weight and increases capacity compared to conventional shapes.



Lattice extension

For improved up and over reach, a bifold lattice extension is available on the TMS800E and manually offsets from 0° to 40°.

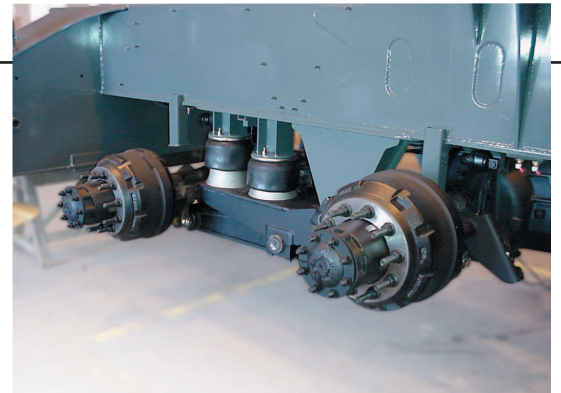

Suspension system

Standard front and rear air ride suspension provides a comfortable ride at maximum speed of 105 km/h (65 mph).

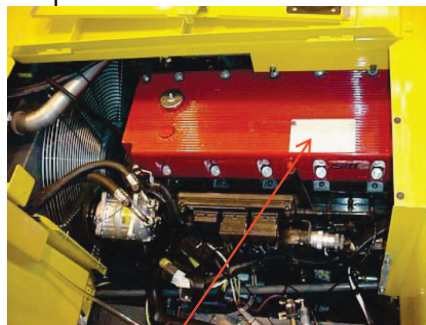

Cummins diesel carrier engine

The electronically controlled Cummins diesel engine provides plenty of power, on highway and at the jobsite.

Contents

Specifications	4
Dimensions	7
Travel proposals	8
Working range	9
Load charts	11
Load handling	35

Specifications

Superstructure



Boom

12,5 m - 39 m (41 ft - 128 ft) four section, full power MEGAFORM™ boom.
Maximum tip height: 41,1 m (135 ft).



Boom nose

Four nylatron sheaves, mounted on heavy duty tapered roller bearings with removable pin type rope guards. Quick Reeve boom nose. Removable auxiliary boom nose with removable pin type rope guard.



Boom elevation

Single lift cylinder with safety valve provides boom angle from -3° to +78°.



Offsettable lattice extension

10 m - 17 m (33 ft - 56 ft) bifold lattice swingaway extension, manual offsettable at 0°, 20° and 40°. Maximum tip height: 58,2 m (191 ft)



* Optional lattice extension

Two 6,1 m (20 ft) inserts for use with lattice swingaway extension to increase length up to 23,2 m (76 ft) or 29,3 m (96 ft). Maximum tip height: 70,1 m (230 ft)



Load moment and anti-two block system

Standard “Graphics Display” load moment and anti-two block system with audio-visual warning and control lever lockout. These systems provide electronic display of boom angle, boom length, radius, tip height, relative load moment, maximum permissible load, load indication and warning of impending two-block condition. The standard “**Work Area Definition System**” allows the operator to pre-select and define safe working areas. If the crane approaches the pre-set limits, audio-visual warnings aid the operator in avoiding job-site obstructions.



Cab

All aluminum constructed cab with acoustical lining, **hydraulically tiltable** (0° to +20°). Includes tinted safety glass, adjustable operator’s seat, sliding windows in side and rear, hinged skylight with wiper, skylight sunscreen. Other features include hot water heater/ defroster, armrest integrated dual axis crane controls, and ergonomically arranged instrumentation.



Swing

Axial piston fixed displacement motor and planetary gear box. Infinitely variable to 1.7 rpm. Holding brake and service brake.



Counterweight

3629 kg (8000 lb) consisting of various sections with hydraulic installation/removal system.

*Optional “Heavy Lift” package consisting of (1) 1814 kg (4000 lb) and (1) 2722 kg (6000 lb) section, for a total of 8165 kg (18,000 lb).

*Optional “XL” counterweight package consisting of (1) 2721 kg (6000 lb) slab, (1) 1814 kg (4000 lb) slab and (2) 1361 kg (3000 lb) wing weights in addition to standard; for a total of 10 886 kg (24,000 lb) of counterweight.



Hydraulic system

1 piston and 3 gear type pumps with a total capacity of 678 l/m (179 gpm). Maximum operating pressure, 27,6 MPa (4000 psi).

Thermostatically controlled oil cooler keeps oil at optimum operating temperature.

Tank capacity: 693 L (183 gal)



Hoist

Main and auxiliary hoist are powered by axial piston motor with planetary gear and brake. “Thumb-thumper” hoist drum rotation indicator alerts operator of hoist movement.

Single line pull: 1st layer: 9185 kg (20,250 lb)
3rd layer: 7716 kg (17,010 lb)
5th layer: 6650 kg (14,660 lb)

Specifications

Superstructure continued

Maximum line speed: 157 m/min (514 fpm)

Maximum permissible line pull:
7620 kg (16 800 lb) 6x36 rope
7620 kg (16 800 lb) 35x7 rope

Rope diameter: 19 mm (3/4 in)

Rope length: 183 m (600 ft) main hoist
185 m (607 ft) auxiliary hoist

Rope type: 6 x 36 EIPS IWRC, Special Flexible
35 x 7 Class, Rotation Resistant

Maximum rope stowage: 256 m (841 ft)

Carrier



Chassis

Triple box section, four-axle carrier, fabricated from high strength, low alloy steel with towing and tie-down lugs.



Outrigger system

Four hydraulic telescoping, two-stage, double box beam outriggers with inverted jack and integral holding valves. Quick release type outrigger floats 610 mm (24 in) diameter. Three position setting with fully extended, intermediate (50%) extended and fully retracted capacities. Maximum outrigger pad load: 101,800 lb



Outrigger controls

Located in the superstructure cab and on either side of the carrier. Crane level indicator (sight bubble).



Engine

Cummins QSM 402 10,8 L diesel Tier 3 (Off Highway EPA Certified) six cylinders, after cooled, 300 kW (402 bhp) (gross) @ 1800 RPM. Maximum torque 1898 Nm (1400 ft lb) @ 1400 RPM.

Equipped with engine compression brake, block heater, cold start aid (less canister) and audio-visual engine distress system.

Fuel Requirement - Maximum of 5000 ppm sulfur content.



Fuel tank capacity

379 L (100 gal).



Transmission

Roadranger manual transmission with 11 speeds forward, three speeds reverse.



Drive

8 x 4 x 4.



Steering

Front axles, single circuit, mechanical steering with hydraulic power assist. Turning radius: 45.1 ft.



Axles

Front: (2) beam-type steering axles, 2,12 m (83.4 in) track.

Rear: (2) single reduction drive axles, 1,89 m (74.5 in) track. Inter-axle differential locks.



Brakes

S-cam, dual air split system operating on all wheels. Spring-applied, air released parking brake acting on rear axles. Air dryer.



Suspension

Front: Walking beam with air bags and shock absorbers.
Rear: Walking beam with air bags and shock absorbers.



Tires

Front: 445/65R 22.5 tubeless, mounted on aluminum disc wheels.

Rear: 315/80R 22.5 tubeless, mounted on aluminum disc wheels, inner steel.



Lights

Full lighting package including turn indicators, head, tail, brake, and hazard warning lights.

Specifications

Carrier continued



Cab

One man design, aluminum fabricated with acoustical lining and tinted safety glass throughout. Deluxe fabric covered seat with air adjustment. Complete driving controls and engine instrumentation including tilt telescope steering wheel, tachometer, speedometer, voltmeter, water temp., oil pressure, fuel level, air pressure gauge with A/V warning and engine high temp./low oil pressure A/V warning. Other standard items include hot water heater/defroster, electric windshield wash/wipe, fire extinguisher, seat belt, door lock, air horn, and air conditioning.



Electrical system

Two 12V – maintenance free batteries provides 12 V electrical system. Standard battery disconnect.



Maximum speed

104 km/h (65 mph)



Gradeability (theoretical)

70%

Miscellaneous standard equipment

Aluminum fenders with rear storage compartments; dual rear view mirrors; electronic back-up alarm; sling/tool box; tire inflation kit; air cleaner restriction indicator; headache ball stowage; aluminum wheels, event recorder.

* Optional equipment

- ▶ Auxiliary Lighting and Convenience Package:
Includes amber strobe for superstructure and carrier cab, dual boom base mounted floodlights and LMI light bar.
- ▶ Hook blocks
- ▶ Pintle hook (rear)
- ▶ Cross axle differential locks
- ▶ Trailing Boom Package
- ▶ Aluminum outrigger pads
- ▶ Counterweight Packages
- ▶ Tow cable
- ▶ Wind speed indicator
- ▶ Winterfront radiator cover

Dimensions

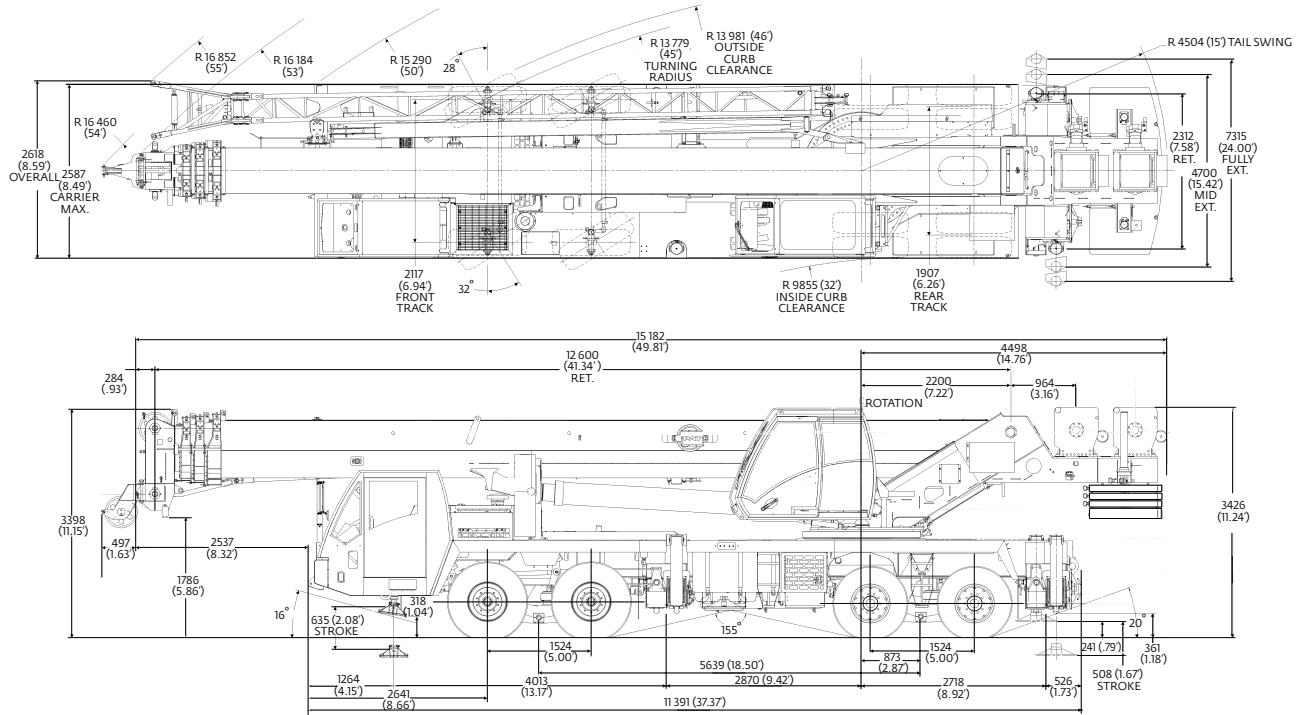

Note: Dimensions shown as mm (ft).

Unit configuration	kg		lb		Gross	
	Front	Rear	Front	Rear	Gross	Gross
Basic machine including 128 ft main boom, 56 ft bifold swingaway, main and auxiliary hoists with cable, auxiliary boom nose, air conditioning in both cabs, 40 USt hook block tied to bumper, 10 USt headache ball stowed, zero counterweight, 200 lb driver	19 933	18 509	(43,943)	(40,804)	38 441	(84,747)
Add 4000 lb counterweight pinned to superstructure	18 965	21 298	(41,809)	(46,954)	40 263	(88,763)
Add 10,000 lb counterweight (6000 lb on deck/4000 lb pinned to superstructure)	21 261	21 729	(46,872)	(47,904)	42 990	(94,776)
Add 14,000 lb counterweight (8000 lb on deck/6000 lb pinned to superstructure)	21 549	23 261	(47,506)	(51,280)	44 809	(98,786)
Add 18,000 lb counterweight (8000 lb on deck/10,000 lb pinned to superstructure)	20 581	26 050	(45,372)	(57,430)	46 631	(102,802)
Substitute:						
Aluminum outrigger pads	-3	-30	(-6)	(-66)	-33	(-72)
Remove:						
33 ft-56 ft bifold swingaway	-1365	166	(-3010)	(365)	-1200	(-2645)
40 USt hook block	-602	229	(-1327)	(504)	-373	(-823)
10 USt headache ball	-380	122	(-838)	(270)	-258	(-568)
Auxiliary hoist with cable	84	-240	(185)	(-530)	-156	(-345)
Air conditioning - carrier	-36	8	(-80)	(17)	-29	(-63)
Air conditioning - superstructure	15	-102	(32)	(-225)	-88	(-193)
Effect per foot of extended boom:						
Axle/tire allowable	-346	346	(762)	(-762)	0	(0)
	22 317	27 216	(49,200)	(60,000)	49 533	(109,200)

Travel proposals

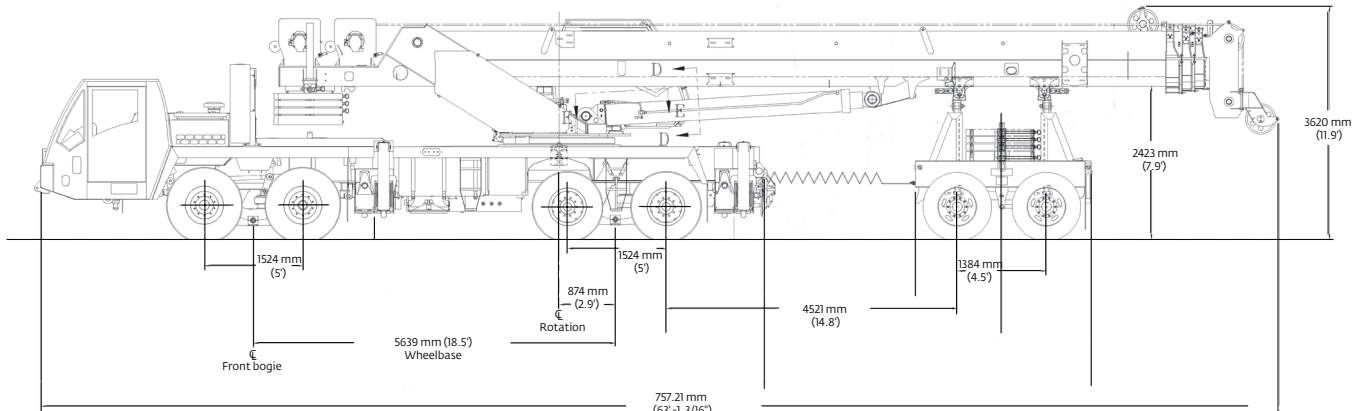

Front
14 779 kg
(32,582 lb)

Rear
15 437 kg
(34,032 lb)

Dolly
11 173 kg
(24,633 lb)

Gross
41 389 kg
(91,247 lb)

Unit Configuration:

- 12,5 m - 39 m (41 ft - 128 ft) boom
- 10 m - 17 m (33 ft - 56 ft) stowed swingaway
- Main and auxiliary hoists with cable
- 40 USt hook block hanging from boom nose
- 10 USt headache ball stowed in front tray

Additions:

- 3629 kg (8000 lb) counterweight stowed on the chassis deck
- 4536 kg (10,000 lb) counterweight stowed on the boom dolly

500 lb of rigging and cribbing

- Driver
- 2 axle boom dolly [2722 kg (6,000 lb)]
- No counterweight
- Air conditioning, both cabs

Front
17 844 kg
(39,339 lb)

Rear
16 012 kg
(35,301 lb)

Dolly
15 721 kg
(34,659 lb)

Gross
49 577 kg
(109,299 lb)

Counterweight configurations

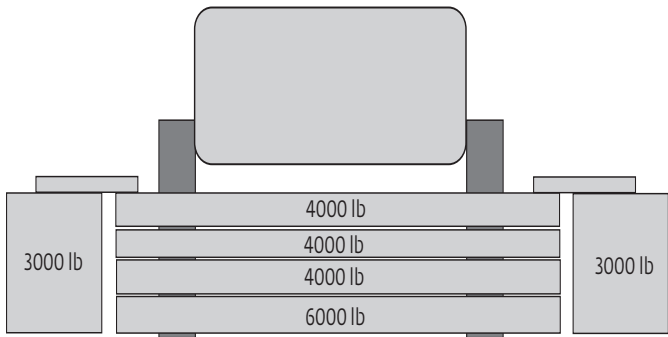

Load chart configurations			
	4000 lb	6000 lb	3000 lb
0 lb			
4000 lb	X		
8000 lb	2X		
10,000 lb	X	X	
12,000 lb	3X		
14,000 lb	2X	X	
18,000 lb	3X	X	
24,000 lb	3X	X	2X

Working range

41.3 ft – 128 ft main boom + 33 ft – 56 ft lattice extension

(Boom deflection not shown)

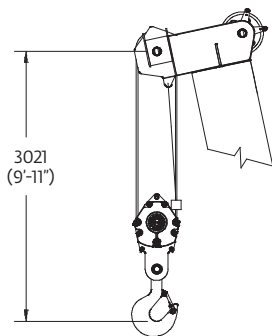
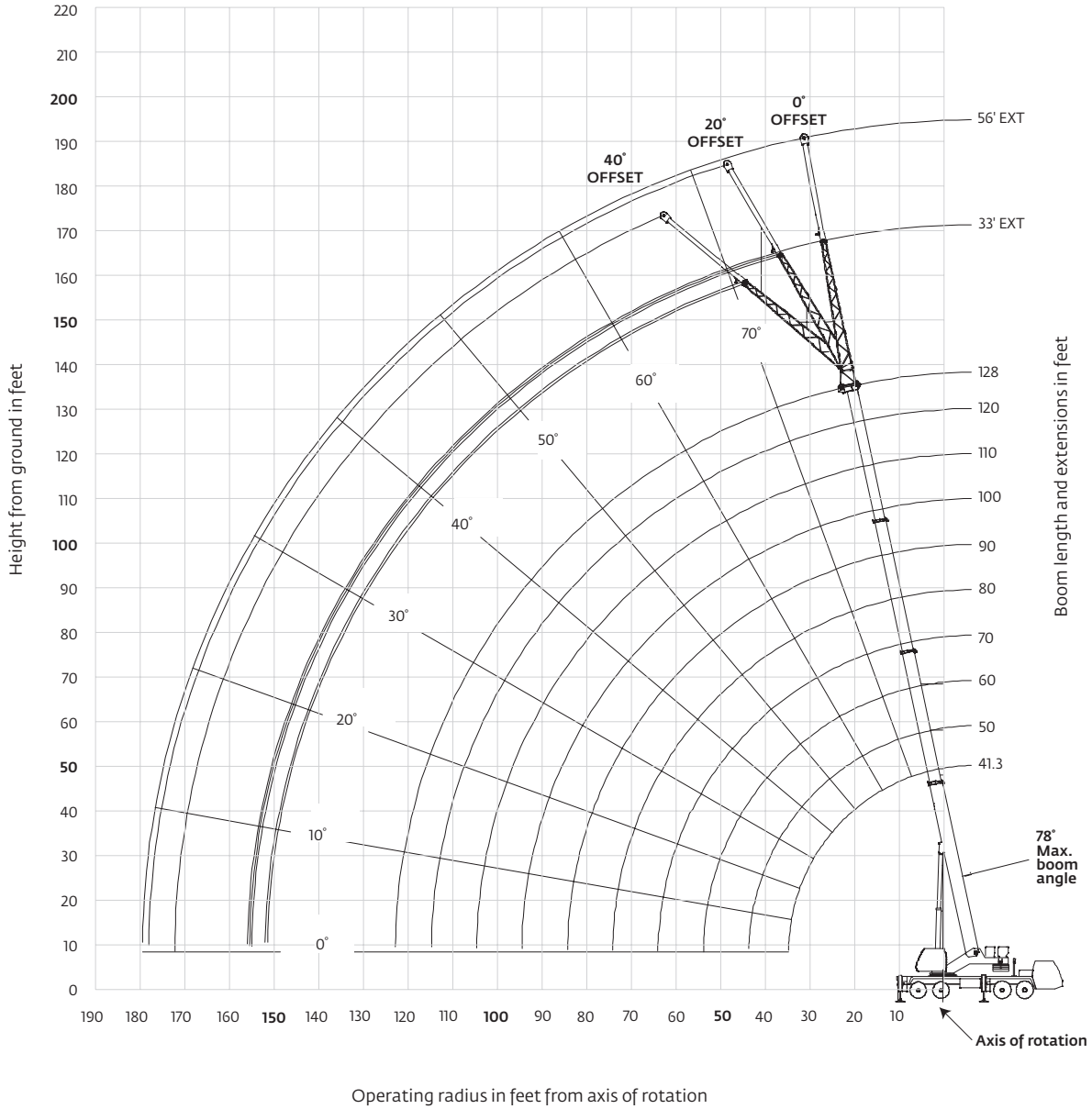

Dimensions are for largest Grove furnished hook block and overhaul ball, with anti-two block activated.

THIS CHART IS ONLY A GUIDE AND SHOULD NOT BE USED TO OPERATE THE CRANE.

Grove TMS800E *The individual crane's load chart, operating instructions and other instructional plates must be read and understood prior to operating the crane.*

Working range

41.3 ft – 128 ft main boom + 33 ft – 56 ft lattice extension + 20 ft or 40 ft insert

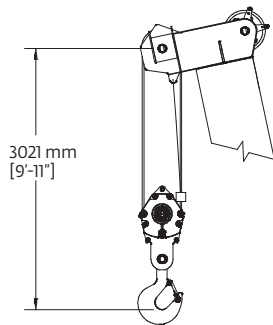
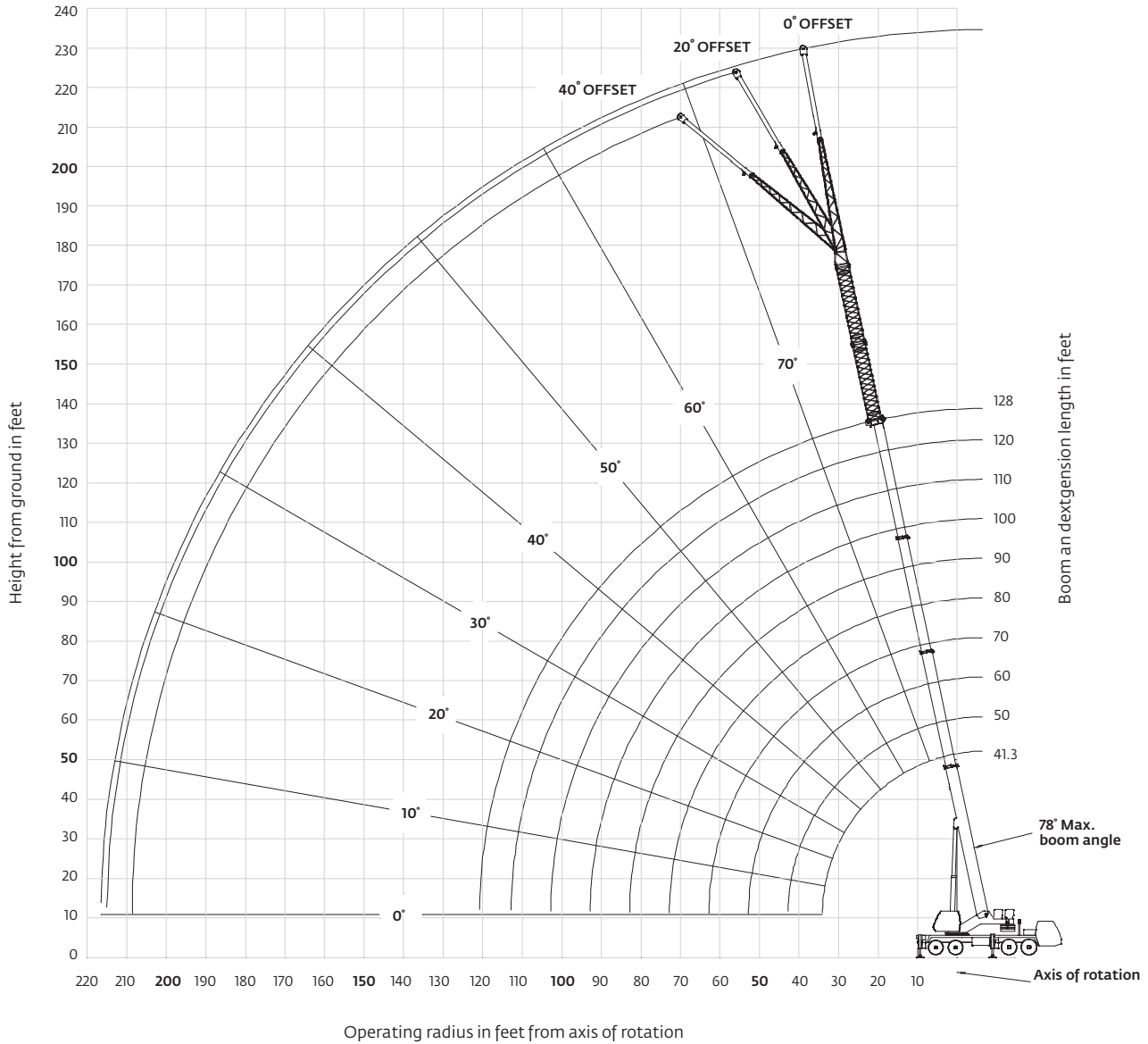

Dimensions are for largest Grove furnished hook block and overhaul ball, with anti-two block activated.

THIS CHART IS ONLY A GUIDE AND SHOULD NOT BE USED TO OPERATE THE CRANE.

The individual crane's load chart, operating instructions and other instructional plates must be read and understood prior to operating the crane.

Load charts

41.3 ft - 128 ft 24,000 lb 100% 360°
 24 ft 0 in spread

Feet	41.3	50	60	**70	80	90	100	110	120	128
8	+160,000 (73)									
9	+++150,000 (71.5)	86,000 (75)								
10	147,000 (70)	86,000 (74)	86,000 (77)							
12	130,500 (67)	86,000 (71.5)	86,000 (75)	41,000 (77)						
15	111,000 (62)	86,000 (67.5)	86,000 (71.5)	41,000 (74.5)	39,000 (76.5)					
20	87,650 (53.5)	86,000 (61)	85,900 (66.5)	41,000 (70)	39,000 (73)	38,800 (75)	*38,700 (78)	*31,950 (78)		
25	67,700 (44)	67,450 (54)	67,250 (61)	41,000 (65.5)	39,000 (69)	38,800 (71.5)	38,700 (74)	31,950 (75.5)	*25,750 (78)	*14,600 (78)
30	50,550 (31)	50,800 (46.5)	50,750 (55.5)	41,000 (61)	39,000 (65)	38,800 (68.5)	36,150 (70.5)	31,950 (72.5)	25,750 (74.5)	14,600 (75.5)
35	38,600 (37)	38,750 (49.5)	38,750 (49.5)	38,650 (56.5)	38,150 (61)	34,100 (65)	31,350 (67.5)	29,300 (70)	25,750 (72)	14,600 (73)
40	30,300 (24)	30,500 (42)	30,500 (42)	30,600 (51)	31,550 (57)	30,050 (61)	27,500 (64.5)	25,650 (67.5)	23,900 (69.5)	14,600 (71)
45			24,550 (33.5)	24,700 (45.5)	25,700 (52.5)	26,500 (57.5)	24,400 (61.5)	22,700 (64.5)	21,450 (67)	14,600 (68.5)
50	See Note 16		20,050 (21.5)	20,250 (39)	21,150 (47.5)	22,050 (53.5)	21,850 (58)	20,250 (61.5)	19,100 (64.5)	14,600 (66)
55				16,750 (31.5)	17,650 (42.5)	18,500 (49.5)	19,300 (54.5)	18,200 (58.5)	17,100 (62)	14,600 (64)
60				13,950 (20.5)	14,800 (36.5)	15,650 (45)	16,450 (51)	16,450 (55.5)	15,450 (59)	14,600 (61.5)
65					12,450 (29)	13,300 (40)	14,150 (47)	14,550 (52)	14,000 (56)	13,350 (59)
70					10,500 (18.5)	11,300 (34)	12,150 (42.5)	12,600 (48.5)	12,700 (53)	12,150 (56)
75						9650 (27.5)	10,500 (38)	10,950 (45)	11,350 (50)	11,050 (53.5)
80						8220 (17.5)	9100 (32.5)	9530 (41)	9950 (47)	10,100 (50.5)
85							7870 (26)	8300 (36.5)	8710 (43)	9090 (47.5)
90							6800 (17)	7220 (31)	7620 (39.5)	8000 (44)
95								6260 (25)	6660 (35)	7030 (40.5)
100								5410 (16)	5810 (30)	6170 (36.5)
105									5040 (24)	5410 (32)
110									4360 (16)	4720 (27)
115										4090 (21)
120										3530 (10)

Minimum boom angle (°) for indicated length (no load) 9

Maximum boom length (ft) at 0° boom angle (no load) 120

#LMI operating code. Refer to LMI manual for instructions.

*This capacity is based upon maximum obtainable boom angle.

Note: () Boom angles are in degrees.

+ Special equipment is required to lift this capacity.

+++9 parts of line required to lift this capacity (using aux. boom nose). Refer to Operator's & Safety Handbook for reeving diagram

Lifting capacities at zero degree boom angle

Boom angle	Main boom length in feet									
	41.3	50	60	**70	80	90	100	110	120	
0°	20,750 (34.1)	15,150 (42.8)	10,500 (52.8)	6700 (63)	5100 (72.8)	3900 (82.8)	2900 (92.8)	2000 (102.8)	1300 (112.8)	

Note: () Reference radii in feet.

**This boom length is with inner-mid fully extended and outer-mid & fly fully retracted.

A6-829-103890

THIS CHART IS ONLY A GUIDE AND SHOULD NOT BE USED TO OPERATE THE CRANE.

Load charts



Pounds						
	33 ft LENGTH			56 ft LENGTH		
	0° OFFSET	20° OFFSET	40° OFFSET	0° OFFSET	20° OFFSET	40° OFFSET
35	[#] 11,900 (78)					
40	11,900 (75.5)			6060 (77.5)		
45	11,900 (73.5)	[#] 11,600 (78)		6060 (76)		
50	11,900 (71.5)	10,600 (75)	[#] 9700 (78)	6060 (74.5)		
55	11,900 (70)	9770 (73)	8470 (75.5)	6060 (73)		
60	11,000 (68)	9020 (71)	7920 (73.5)	6060 (71)	[#] 6040 (78)	
65	10,000 (66)	8360 (69.5)	7430 (72)	6060 (69.5)	5900 (75)	
70	9190 (64)	7780 (67.5)	6980 (70)	6060 (68)	5730 (73.5)	[#] 4930 (78)
75	8460 (62)	7260 (65.5)	6580 (68)	6060 (66)	5330 (71.5)	4640 (76)
80	7820 (60)	6790 (63.5)	6210 (65.5)	6040 (64.5)	4980 (70)	4370 (74)
85	7250 (58)	6370 (61)	5870 (63.5)	5570 (63)	4650 (68)	4120 (72)
90	6740 (55.5)	5990 (59)	5560 (61)	5150 (61)	4360 (66.5)	3890 (70)
95	6290 (53.5)	5640 (56.5)	5280 (59)	4780 (59.5)	4090 (64.5)	3680 (68.5)
100	5880 (51)	5320 (54.5)	5020 (56.5)	4440 (57.5)	3840 (62.5)	3480 (66.5)
105	5510 (48.5)	5030 (52)	4770 (54)	4130 (55.5)	3610 (60.5)	3300 (64.5)
110	5170 (46)	4760 (49.5)	4550 (51)	3850 (53.5)	3400 (58.5)	3130 (62.5)
115	4780 (43.5)	4510 (46.5)	4340 (48.5)	3590 (52)	3200 (56.5)	2970 (60)
120	4200 (40.5)	4280 (44)	4150 (45)	3360 (49.5)	3020 (54.5)	2820 (58)
125	3660 (37.5)	3960 (41)		3140 (47.5)	2840 (52.5)	2680 (55.5)
130	3170 (34)	3420 (37.5)		2940 (45.5)	2690 (50)	2540 (53)
135	2710 (30.5)	2930 (34)		2760 (43)	2540 (48)	2420 (50.5)
140	2290 (26.5)	2470 (29.5)		2590 (40.5)	2400 (45)	2300 (47.5)
145	1910 (21.5)			2430 (38)	2270 (42.5)	
150	1550 (14.5)			2100 (35)	2140 (39.5)	
155				1770 (31.5)	2030 (36)	
160				1470 (28)	1770 (32.5)	
165				1180 (24)		

Minimum boom angle (°) for indicated length (no load)	13	28	43.5	19	31.5	46
---	----	----	------	----	------	----

Maximum boom length (ft) at 0° boom angle (no load)		110		110		
---	--	-----	--	-----	--	--

NOTE: () Boom angles are in degrees.
 #LMI operating code. Refer to LMI manual for operating instructions.
 *This capacity is based upon maximum boom angle.

NOTES:

1. All capacities above the bold line are based on structural strength of boom extension and do not exceed 85% of tipping loads, in accordance with SAE J-765.

2. The 33 ft extension length may be used with single or double part line lifting service. The 56 ft extension length may be used for single line lifting service only.

3. For main boom lengths less than 128 ft with the boom extension erected, the rated loads are determined by boom angle. Use only the column which corresponds to the boom extension length and offset for which the machine is set up. For boom angles not shown, use rating of the next lower boom angle.

4. **WARNING:** Operation of this machine with heavier loads than the capacities listed is strictly prohibited. Machine tipping with boom extension occurs rapidly and without advance warning.

5. Boom angle is the angle above or below horizontal of the longitudinal axis of the boom base section after lifting rated load.

6. Capacities listed are with outriggers properly extended and vertical jacks set only.

7. When lifting over the main boom nose with 33 ft or 56 ft extension erected, the outriggers must be fully extended or 50% extended (15 ft 5 in spread).

A6-829-103892

Load charts

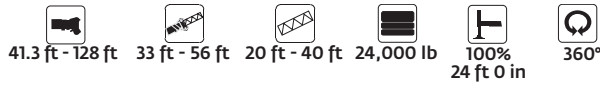

Pounds						
	76 ft (56 ft LENGTH + 1 INSERT)			96 ft (56 ft LENGTH + 2 INSERTS)		
	0° OFFSET	20° OFFSET	40° OFFSET	0° OFFSET	20° OFFSET	40° OFFSET
50	4850 (77.5)					
55	4850 (76)			3520 (78)		
60	4850 (74.5)			3520 (77)		
65	4850 (73)	*5290 (78)		3520 (75.5)		
70	4850 (71.5)	4860 (76.5)		3520 (74)		
75	4850 (70)	4470 (75)		3520 (72.5)	3740 (77)	
80	4730 (68.5)	4110 (73.5)	4050 (77)	3520 (71.5)	3420 (75.5)	
85	4310 (67)	3790 (72)	3500 (75.5)	3300 (70)	3100 (74.5)	*3250 (78)
90	3940 (65.5)	3500 (70)	3260 (73.5)	2970 (68.5)	2820 (73)	2720 (76)
95	3610 (63.5)	3240 (68.5)	3030 (72)	2660 (67)	2560 (71.5)	2490 (74.5)
100	3310 (62)	3000 (67)	2830 (70.5)	2390 (65.5)	2320 (70)	2270 (73)
105	3040 (60.5)	2770 (65)	2630 (68.5)	2140 (64)	2100 (68.5)	2070 (71.5)
110	2790 (59)	2570 (63.5)	2450 (66.5)	1920 (62.5)	1900 (67)	1890 (70)
115	2560 (57)	2370 (61.5)	2280 (65)	1710 (61)	1710 (65.5)	1710 (68.5)
120	2350 (55.5)	2200 (60)	2120 (63)	1520 (59.5)	1540 (64)	1550 (66.5)
125	2160 (53.5)	2030 (58)	1970 (61)	1350 (58)	1380 (62.5)	1390 (65)
130	1990 (52)	1880 (56.5)	1830 (59)	1190 (56.5)	1230 (60.5)	1250 (63.5)
135	1820 (50)	1730 (54.5)	1700 (57)	1040 (55)	1080 (59)	1110 (61.5)
140	1670 (48)	1590 (52.5)	1570 (55)			
145	1530 (46)	1470 (50.5)	1450 (52.5)			
150	1400 (43.5)	1340 (48)	1340 (50.5)			
155	1270 (41.5)	1230 (46)	1230 (48)			
160	1160 (39)	1120 (43.5)	1130 (45)			
165	1050 (36.5)	1020 (40.5)				

Minimum boom angle (°) for indicated length (no load)	35	39	43.5	53.5	58	60.5
---	----	----	------	------	----	------

Maximum boom length (ft) at 0° boom angle (no load)	70			70		
---	----	--	--	----	--	--

NOTE: () Boom angles are in degrees.
 #LMI operating code. Refer to LMI manual for operating instructions.
 *This capacity is based upon maximum boom angle.

A6-829-103894

NOTES:
 1. All capacities above the bold line are based on structural strength of boom extension and do not exceed 85% of tipping loads, in accordance with SAE J-765.

2. The 33 ft extension length may be used with single or double part line lifting service. The 56 ft extension length may be used for single line lifting service only.

3. For main boom lengths less than 128 ft with the boom extension erected, the rated loads are determined by boom angle. Use only the column which corresponds to the boom extension length and offset for which the machine is set up. For boom angles not shown, use rating of the next lower boom angle.

4. **WARNING:** Operation of this machine with heavier loads than the capacities listed is strictly prohibited. Machine tipping with boom extension occurs rapidly and without advance warning.

5. Boom angle is the angle above or below horizontal of the longitudinal axis of the boom base section after lifting rated load.

6. Capacities listed are with outriggers properly extended and vertical jacks set only.

7. When lifting over the main boom nose with 33 ft or 56 ft extension erected, the outriggers must be fully extended or 50% extended (15 ft 5 in spread).

Load charts

Feet	Pounds									
	Main boom length in feet									
	41.3	50	60	**70	80	90	100	110	120	128
8	+160,000 (73)									
9	++150,000 (71.5)	86,000 (75)								
10	147,000 (70)	86,000 (74)	86,000 (77)							
12	130,500 (67)	86,000 (71.5)	86,000 (75)	41,000 (77)						
15	111,000 (62)	86,000 (67.5)	86,000 (71.5)	41,000 (74.5)	39,000 (76.5)					
20	87,650 (53.5)	86,000 (61)	85,900 (66.5)	41,000 (70)	39,000 (73)	38,800 (75)	*38,700 (78)	*31,950 (78)		
25	63,700 (44)	63,750 (54)	63,300 (61)	41,000 (65.5)	39,000 (69)	38,800 (71.5)	38,700 (74)	31,950 (75.5)	*25,750 (78)	*14,600 (78)
30	45,450 (31)	45,650 (46.5)	45,600 (55.5)	41,000 (61)	39,000 (65)	38,800 (68.5)	36,150 (70.5)	31,950 (72.5)	25,750 (74.5)	14,600 (75.5)
35		34,450 (37)	34,550 (49.5)	34,500 (56.5)	35,450 (61)	34,100 (65)	31,350 (67.5)	29,300 (70)	25,750 (72)	14,600 (73)
40		26,800 (24)	27,000 (42)	27,100 (51)	28,050 (57)	28,950 (61)	27,500 (64.5)	25,650 (67.5)	23,900 (69.5)	14,600 (71)
45			21,550 (33.5)	21,700 (45.5)	22,650 (52.5)	23,500 (57.5)	24,350 (61.5)	22,700 (64.5)	21,450 (67)	14,600 (68.5)
50			17,450 (21.5)	17,600 (39)	18,550 (47.5)	19,450 (53.5)	20,200 (58)	20,250 (61.5)	19,100 (64.5)	14,600 (66)
55				14,400 (31.5)	15,300 (42.5)	16,150 (49.5)	16,950 (54.5)	17,300 (58.5)	17,100 (62)	14,600 (64)
60				11,800 (20.5)	12,700 (36.5)	13,500 (45)	14,350 (51)	14,750 (55.5)	15,100 (59)	14,600 (61.5)
65					10,550 (29)	11,350 (40)	12,200 (47)	12,600 (52)	13,000 (56)	13,350 (59)
70					8760 (18.5)	9550 (34)	10,400 (42.5)	10,850 (48.5)	11,250 (53)	11,600 (56)
75						8010 (27.5)	8890 (38)	9320 (45)	9740 (50)	10,100 (53.5)
80						6690 (17.5)	7580 (32.5)	8010 (41)	8430 (47)	8790 (50.5)
85							6450 (26)	6880 (36.5)	7290 (43)	7670 (47.5)
90							5460 (17)	5880 (31)	6290 (39.5)	6670 (44)
95								5000 (25)	5410 (35)	5780 (40.5)
100								4220 (16)	4620 (30)	4990 (36.5)
105									3920 (24)	4280 (32)
110									3280 (16)	3650 (27)
115										3080 (21)
120										2560 (10)
Minimum boom angle (°) for indicated length (no load)										9
Maximum boom length (ft) at 0° boom angle (no load)										120

#LMI operating code. Refer to LMI manual for instructions.
 *This capacity is based upon maximum obtainable boom angle.
 Note: () Boom angles are in degrees.
 + Special equipment is required to lift this capacity.
 ++9 parts of line required to lift this capacity (using aux. boom nose). Refer to Operator's & Safety Handbook for reeving diagram.

Lifting capacities at zero degree boom angle

Boom angle	Main boom length in feet								
	41.3	50	60	**70	80	90	100	110	120
0°	20,750 (34.1)	15,150 (42.8)	10,500 (52.8)	6700 (63)	5100 (72.8)	3900 (82.8)	2900 (92.8)	2000 (102.8)	1300 (112.8)

Note: () Reference radii in feet. **This boom length is with inner-mid fully extended and outer-mid & fly fully retracted. A6-829-103749

Load charts

 41.3 ft - 128 ft
  33 ft - 56 ft
  18,000 lb
  100%
24 ft 0 in
  360°

		Pounds					
		33 ft LENGTH			56 ft LENGTH		
Feet	0° OFFSET	20° OFFSET	40° OFFSET	0° OFFSET	20° OFFSET	40° OFFSET	
35	[*] 11,900 (78)						
40	11,900 (75.5)			6060 (77.5)			
45	11,900 (73.5)	[*] 11,600 (78)		6060 (76)			
50	11,900 (71.5)	10,600 (75)	[*] 9700 (78)	6060 (74.5)			
55	11,900 (70)	9770 (73)	8470 (75.5)	6060 (73)			
60	11,000 (68)	9020 (71)	7920 (73.5)	6060 (71)	[*] 6040 (78)		
65	10,000 (66)	8360 (69.5)	7430 (72)	6060 (69.5)	5900 (75)		
70	9190 (64)	7780 (67.5)	6980 (70)	6060 (68)	5730 (73.5)	[*] 4930 (78)	
75	8460 (62)	7260 (65.5)	6580 (68)	6060 (66)	5330 (71.5)	4640 (76)	
80	7820 (60)	6790 (63.5)	6210 (65.5)	6040 (64.5)	4980 (70)	4370 (74)	
85	7250 (58)	6370 (61)	5870 (63.5)	5570 (63)	4650 (68)	4120 (72)	
90	6740 (55.5)	5990 (59)	5560 (61)	5150 (61)	4360 (66.5)	3890 (70)	
95	6290 (53.5)	5640 (56.5)	5280 (59)	4780 (59.5)	4090 (64.5)	3680 (68.5)	
100	5750 (51)	5320 (54.5)	5020 (56.5)	4440 (57.5)	3840 (62.5)	3480 (66.5)	
105	5020 (48.5)	5030 (52)	4770 (54)	4130 (55.5)	3610 (60.5)	3300 (64.5)	
110	4360 (46)	4760 (49.5)	4550 (51)	3850 (53.5)	3400 (58.5)	3130 (62.5)	
115	3760 (43.5)	4150 (46.5)	4340 (48.5)	3590 (52)	3200 (56.5)	2970 (60)	
120	3220 (40.5)	3560 (44)	3840 (45)	3360 (49.5)	3020 (54.5)	2820 (58)	
125	2710 (37.5)	3020 (41)		3140 (47.5)	2840 (52.5)	2680 (55.5)	
130	2250 (34)	2520 (37.5)		2810 (45.5)	2690 (50)	2540 (53)	
135	1830 (30.5)	2070 (34)		2400 (43)	2540 (48)	2420 (50.5)	
140	1440 (26.5)	1640 (29.5)		2030 (40.5)	2400 (45)	2300 (47.5)	
145	1080 (21.5)			1690 (38)	2110 (42.5)		
150				1370 (35)	1730 (39.5)		
155				1070 (31.5)	1380 (36)		
160					1060 (32.5)		
Minimum boom angle (°) for indicated length (no load)		20	28	43.5	30	31.5	46
Maximum boom length (ft) at 0° boom angle (no load)		110			100		

NOTE: () Boom angles are in degrees. A6-829-10377
 #LMI operating code. Refer to LMI manual for operating instructions.
 *This capacity is based upon maximum boom angle.

NOTES:

1. All capacities above the bold line are based on structural strength of boom extension and do not exceed 85% of tipping loads, in accordance with SAE J-765.

2. The 33 ft extension length may be used with single or double part line lifting service. The 56 ft extension length may be used for single line lifting service only.

3. For main boom lengths less than 128 ft with the boom extension erected, the rated loads are determined by boom angle. Use only the column which corresponds to the boom extension length and offset for which the machine is set up. For boom angles not shown, use rating of the next lower boom angle.

4. WARNING: Operation of this machine with heavier loads than the capacities listed is strictly prohibited. Machine tipping with boom extension occurs rapidly and without advance warning.

5. Boom angle is the angle above or below horizontal of the longitudinal axis of the boom base section after lifting rated load.

6. Capacities listed are with outriggers properly extended and vertical jacks set only.

7. When lifting over the main boom nose with 33 ft or 56 ft extension erected, the outriggers must be fully extended or 50% extended (15 ft 5 in spread).

THIS CHART IS ONLY A GUIDE AND SHOULD NOT BE USED TO OPERATE THE CRANE.

Load charts

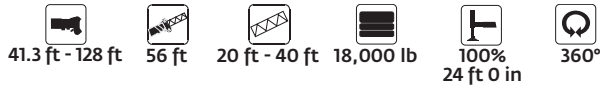

Pounds						
Feet	76 ft (56 ft LENGTH + 1 INSERT)			96 ft (56 ft LENGTH + 2 INSERTS)		
	0° OFFSET	20° OFFSET	40° OFFSET	0° OFFSET	20° OFFSET	40° OFFSET
50	4850 (77.5)					
55	4850 (76)			3520 (78)		
60	4850 (74.5)			3520 (77)		
65	4850 (73)	*5290 (78)		3520 (75.5)		
70	4850 (71.5)	4860 (76.5)		3520 (74)		
75	4850 (70)	4470 (75)		3520 (72.5)	3740 (77)	
80	4730 (68.5)	4110 (73.5)	4050 (77)	3520 (71.5)	3420 (75.5)	
85	4310 (67)	3790 (72)	3500 (75.5)	3300 (70)	3100 (74.5)	*3250 (78)
90	3940 (65.5)	3500 (70)	3260 (73.5)	2970 (68.5)	2820 (73)	2720 (76)
95	3610 (63.5)	3240 (68.5)	3030 (72)	2660 (67)	2560 (71.5)	2490 (74.5)
100	3310 (62)	3000 (67)	2830 (70.5)	2390 (65.5)	2320 (70)	2270 (73)
105	3040 (60.5)	2770 (65)	2630 (68.5)	2140 (64)	2100 (68.5)	2070 (71.5)
110	2790 (59)	2570 (63.5)	2450 (66.5)	1920 (62.5)	1900 (67)	1890 (70)
115	2560 (57)	2370 (61.5)	2280 (65)	1710 (61)	1710 (65.5)	1710 (68.5)
120	2350 (55.5)	2200 (60)	2120 (63)	1520 (59.5)	1540 (64)	1550 (66.5)
125	2160 (53.5)	2030 (58)	1970 (61)	1350 (58)	1380 (62.5)	1390 (65)
130	1990 (52)	1880 (56.5)	1830 (59)	1190 (56.5)	1230 (60.5)	1250 (63.5)
135	1820 (50)	1730 (54.5)	1700 (57)	1040 (55)	1080 (59)	1110 (61.5)
140	1670 (48)	1590 (52.5)	1570 (55)			
145	1530 (46)	1470 (50.5)	1450 (52.5)			
150	1400 (43.5)	1340 (48)	1340 (50.5)			
155	1160 (41.5)	1230 (46)	1230 (48)			
160		1120 (43.5)	1130 (45)			
Minimum boom angle (°) for indicated length (no load)	39	40.5	43.5	53.5	58	60.5
Maximum boom length (ft) at 0° boom angle (no load)		70			70	

NOTE: () Boom angles are in degrees. AG-829-103785
 #LMI operating code. Refer to LMI manual for operating instructions.
 *This capacity is based upon maximum boom angle.

NOTES:

1. All capacities above the bold line are based on structural strength of boom extension and do not exceed 85% of tipping loads, in accordance with SAE J-765.

2. The 56 ft extension length may be used for single line lifting service only.

3. For main boom lengths less than 128 ft with the boom extension erected, the rated loads are determined by boom angle. Use only the column which corresponds to the boom extension length and offset for which the machine is set up. For boom angles not shown, use rating of the next lower boom angle.

4. **WARNING:** Operation of this machine with heavier loads than the capacities listed is strictly prohibited. Machine tipping with boom extension occurs rapidly and without advance warning.

5. Boom angle is the angle above or below horizontal of the longitudinal axis of the boom base section after lifting rated load.

6. Capacities listed are with outriggers properly extended and vertical jacks set only.

7. When lifting over the main boom nose with 56 ft extension erected and inserts, the outriggers must be fully extended and vertical jacks set.

Load charts





Feet	Main boom length in feet									
	41.3	50	60	70	80	90	100	110	120	128
8	++150,000 (73)									
9	++150,000 (71.5)	86,000 (75)								
10	145,500 (70)	86,000 (74)	86,000 (77)							
12	129,000 (67)	86,000 (71.5)	86,000 (77)	41,000 (77)						
15	110,000 (62)	86,000 (67.5)	86,000 (71.5)	41,000 (74.5)	39,000 (76.5)					
20	85,200 (53.5)	84,900 (61)	84,650 (66.5)	41,000 (70)	39,000 (73)	38,800 (75)	*38,700 (78)	*31,950 (78)		
25	59,150 (44)	59,150 (54)	58,700 (61)	41,000 (65.5)	39,000 (69)	38,800 (71.5)	38,700 (74)	31,950 (75.5)	*25,750 (78)	*14,600 (78)
30	41,950 (31)	42,150 (46.5)	42,100 (55.5)	41,000 (61)	39,000 (65)	38,800 (68.5)	36,150 (70.5)	31,950 (72.5)	25,750 (74.5)	14,600 (75.5)
35		31,600 (37)	31,750 (49.5)	31,700 (56.5)	32,600 (61)	33,600 (65)	31,350 (67.5)	29,300 (70)	25,750 (72)	14,600 (73)
40		24,450 (24)	24,650 (42)	24,750 (51)	25,650 (57)	26,550 (61)	27,500 (64.5)	25,650 (67.5)	23,900 (69.5)	14,600 (71)
45			19,500 (33.5)	19,650 (45.5)	20,650 (52.5)	21,500 (57.5)	22,350 (61.5)	22,650 (64.5)	21,450 (67)	14,600 (68.5)
50			15,650 (21.5)	15,800 (39)	16,750 (47.5)	17,650 (53.5)	18,400 (58)	18,750 (61.5)	19,100 (64.5)	14,600 (66)
55				12,800 (31.5)	13,700 (42.5)	14,550 (49.5)	15,350 (54.5)	15,700 (58.5)	16,100 (62)	14,600 (64)
60				10,400 (20.5)	11,250 (36.5)	12,050 (45)	12,900 (51)	13,300 (55.5)	13,650 (59)	14,150 (61.5)
65					9240 (29)	10,050 (40)	10,900 (47)	11,300 (52)	11,700 (56)	12,100 (59)
70					7550 (18.5)	8350 (34)	9220 (42.5)	9650 (48.5)	10,050 (53)	10,400 (56)
75						6900 (27.5)	7780 (38)	8210 (45)	8630 (50)	8980 (53.5)
80						5660 (17.5)	6550 (32.5)	6980 (41)	7390 (47)	7760 (50.5)
85							5490 (26)	5910 (36.5)	6320 (43)	6700 (47.5)
90							4560 (17)	4980 (31)	5380 (39.5)	5770 (44)
95								4150 (25)	4550 (35)	4930 (40.5)
100								3420 (16)	3810 (30)	4190 (36.5)
105									3150 (24)	3520 (32)
110									2560 (16)	2930 (27)
115										2390 (21)
120										1900 (10)

Minimum boom angle (°) for indicated length (no load) 9

Maximum boom length (ft) at 0 deg. boom angle (no load) 120

#LMI operating code. Refer to LMI manual for instructions.
 *This capacity is based upon maximum obtainable boom angle.
 Note: () Boom angles are in degrees.
 ++9 parts of line required to lift this capacity (using aux. boom nose). Refer to Operator's & Safety Handbook for reeving diagram.

Boom angle	Lifting capacities at zero degree boom angle								
	Main boom length in feet								
	41.3	50	60	70	80	90	100	110	120
0°	20,750 (34.1)	15,150 (42.8)	10,500 (52.8)	6700 (63)	5100 (72.8)	3900 (82.8)	2900 (92.8)	2000 (102.8)	1300 (112.8)

Note: () Reference radii in feet. A6-829-103750
 **This boom length is with inner-mid fully extended and outer-mid & fly fully retracted.

THIS CHART IS ONLY A GUIDE AND SHOULD NOT BE USED TO OPERATE THE CRANE.

Load charts







 41.3 ft - 128 ft 33 ft - 56 ft 14,000 lb 100% 360°
 24 ft 0 in

Pounds						
Feet	33 ft LENGTH			56 ft LENGTH		
	0° OFFSET	20° OFFSET	40° OFFSET	0° OFFSET	20° OFFSET	40° OFFSET
35	^o 11,900 (78)					
40	11,900 (75.5)			6060 (77.5)		
45	11,900 (73.5)	^o 11,600 (78)		6060 (76)		
50	11,900 (71.5)	10,600 (75)	^o 9700 (78)	6060 (74.5)		
55	11,900 (70)	9770 (73)	8470 (75.5)	6060 (73)		
60	11,000 (68)	9020 (71)	7920 (73.5)	6060 (71)	^o 6040 (78)	
65	10,000 (66)	8360 (69.5)	7430 (72)	6060 (69.5)	5900 (75)	
70	9190 (64)	7780 (67.5)	6980 (70)	6060 (68)	5730 (73.5)	^o 4930 (78)
75	8460 (62)	7260 (65.5)	6580 (68)	6060 (66)	5330 (71.5)	4640 (76)
80	7820 (60)	6790 (63.5)	6210 (65.5)	6040 (64.5)	4980 (70)	4370 (74)
85	7250 (58)	6370 (61)	5870 (63.5)	5570 (63)	4650 (68)	4120 (72)
90	6570 (55.5)	5990 (59)	5560 (61)	5150 (61)	4360 (66.5)	3890 (70)
95	5710 (53.5)	5640 (56.5)	5280 (59)	4780 (59.5)	4090 (64.5)	3680 (68.5)
100	4940 (51)	5320 (54.5)	5020 (56.5)	4440 (57.5)	3840 (62.5)	3480 (66.5)
105	4250 (48.5)	4750 (52)	4770 (54)	4130 (55.5)	3610 (60.5)	3300 (64.5)
110	3630 (46)	4070 (49.5)	4410 (51)	3850 (53.5)	3400 (58.5)	3130 (62.5)
115	3070 (43.5)	3460 (46.5)	3760 (48.5)	3550 (52)	3200 (56.5)	2970 (60)
120	2550 (40.5)	2900 (44)	3170 (45)	3060 (49.5)	3020 (54.5)	2820 (58)
125	2080 (37.5)	2390 (41)		2610 (47.5)	2840 (52.5)	2680 (55.5)
130	1650 (34)	1920 (37.5)		2200 (45.5)	2690 (50)	2540 (53)
135	1250 (30.5)	1480 (34)		1820 (43)	2370 (48)	2420 (50.5)
140		1080 (29.5)		1470 (40.5)	1950 (45)	2220 (47.5)
145				1150 (38)	1570 (42.5)	
150					1210 (39.5)	
Minimum boom angle (°) for indicated length (no load)	26.5	28.5	43.5	35	36	46
Maximum boom length (ft) at 0° boom angle (no load)		110		90		

NOTE: () Boom angles are in degrees. A6-829-103772
 #LMI operating code. Refer to LMI manual for operating instructions.
^oThis capacity is based upon maximum boom angle.

NOTES:

1. All capacities above the bold line are based on structural strength of boom extension and do not exceed 85% of tipping loads, in accordance with SAE J-765.

2. The 33 ft extension length may be used with single or double part line lifting service. The 56 ft extension length may be used for single line lifting service only.

3. For main boom lengths less than 128 ft with the boom extension erected, the rated loads are determined by boom angle. Use only the column which corresponds to the boom extension length and offset for which the machine is set up. For boom angles not shown, use rating of the next lower boom angle.

4. **WARNING:** Operation of this machine with heavier loads than the capacities listed is strictly prohibited. Machine tipping with boom extension occurs rapidly and without advance warning.

5. Boom angle is the angle above or below horizontal of the longitudinal axis of the boom base section after lifting rated load.

6. Capacities listed are with outriggers properly extended and vertical jacks set only.

7. When lifting over the main boom nose with 33 ft or 56 ft extension erected, the outriggers must be fully extended or 50% extended (15 ft 5 in spread).

Load charts



Pounds						
Feet	76 ft (56 ft LENGTH + 1 INSERT)			96 ft (56 ft LENGTH + 2 INSERTS)		
	0° OFFSET	20° OFFSET	40° OFFSET	0° OFFSET	20° OFFSET	40° OFFSET
50	4850 (77.5)					
55	4850 (76)			3520 (78)		
60	4850 (74.5)			3520 (77)		
65	4850 (73)	*5290 (78)		3520 (75.5)		
70	4850 (71.5)	4860 (76.5)		3520 (74)		
75	4850 (70)	4470 (75)		3520 (72.5)	3740 (77)	
80	4730 (68.5)	4110 (73.5)	4050 (77)	3520 (71.5)	3420 (75.5)	
85	4310 (67)	3790 (72)	3500 (75.5)	3300 (70)	3100 (74.5)	*3250 (78)
90	3940 (65.5)	3500 (70)	3260 (73.5)	2970 (68.5)	2820 (73)	2720 (76)
95	3610 (63.5)	3240 (68.5)	3030 (72)	2660 (67)	2560 (71.5)	2490 (74.5)
100	3310 (62)	3000 (67)	2830 (70.5)	2390 (65.5)	2320 (70)	2270 (73)
105	3040 (60.5)	2770 (65)	2630 (68.5)	2140 (64)	2100 (68.5)	2070 (71.5)
110	2790 (59)	2570 (63.5)	2450 (66.5)	1920 (62.5)	1900 (67)	1890 (70)
115	2560 (57)	2370 (61.5)	2280 (65)	1710 (61)	1710 (65.5)	1710 (68.5)
120	2350 (55.5)	2200 (60)	2120 (63)	1520 (59.5)	1540 (64)	1550 (66.5)
125	2160 (53.5)	2030 (58)	1970 (61)	1350 (58)	1380 (62.5)	1390 (65)
130	1990 (52)	1880 (56.5)	1830 (59)	1190 (56.5)	1230 (60.5)	1250 (63.5)
135	1820 (50)	1730 (54.5)	1700 (57)	1040 (55)	1080 (59)	1110 (61.5)
140	1600 (48)	1590 (52.5)	1570 (55)			
145	1260 (46)	1470 (50.5)	1450 (52.5)			
150		1340 (48)	1340 (50.5)			
155		1100 (46)	1230 (48)			
160			1020 (45)			

Minimum boom angle (°) for indicated length (no load)

43.5	44.5	44	53.5	58	60.5
------	------	----	------	----	------

Maximum boom length (ft) at 0° boom angle (no load)

70	60
----	----

NOTE: () Boom angles are in degrees. A6-829-103786
 #LMI operating code. Refer to LMI manual for operating instructions.
 *This capacity is based upon maximum boom angle.

NOTES:

1. All capacities above the bold line are based on structural strength of boom extension and do not exceed 85% of tipping loads, in accordance with SAE J-765.

2. The 56 ft extension length may be used for single line lifting service only.

3. For main boom lengths less than 128 ft. with the boom extension erected, the rated loads are determined by boom angle. Use only the column which corresponds to the boom extension length and offset for which the machine is set up. For boom angles not shown, use rating of the next lower boom angle.

4. **WARNING:** Operation of this machine with heavier loads than the capacities listed is strictly prohibited. Machine tipping with boom extension occurs rapidly and without advance warning.

5. Boom angle is the angle above or below horizontal of the longitudinal axis of the boom base section after lifting rated load.

6. Capacities listed are with outriggers properly extended and vertical jacks set only.

7. When lifting over the main boom nose with 56 ft extension erected and inserts, the outriggers must be fully extended and vertical jacks set.

THIS CHART IS ONLY A GUIDE AND SHOULD NOT BE USED TO OPERATE THE CRANE.

Load charts

 41.3 ft - 128 ft
  12,000 lb
  100%
 24 ft 0 in
  360°

Feet	Main boom length in feet									
	41.3	50	60	**70	80	90	100	110	120	128
8	++150,000 (73)									
9	++150,000 (71.5)									
10	145,000 (70)	86,000 (74)	86,000 (77)							
12	128,500 (67)	86,000 (71.5)	86,000 (75)	41,000 (77)						
15	110,000 (62)	86,000 (67.5)	86,000 (71.5)	41,000 (74.5)	39,000 (76.5)					
20	83,950 (53.5)	83,650 (61)	83,450 (66.5)	41,000 (70)	39,000 (73)	38,800 (75)	*38,700 (78)	*31,950 (78)		
25	56,850 (44)	56,900 (54)	56,450 (61)	41,000 (65.5)	39,000 (69)	38,800 (71.5)	38,700 (74)	31,950 (75.5)	*25,750 (78)	*14,600 (78)
30	40,200 (31)	40,400 (46.5)	40,350 (55.5)	40,050 (61)	39,000 (65)	38,800 (68.5)	36,150 (70.5)	31,950 (72.5)	25,750 (69.5)	14,600 (75.5)
35	30,200 (37)		30,350 (49.5)	30,250 (56.5)	31,200 (61)	32,200 (65)	31,350 (67.5)	29,300 (70)	25,750 (72)	14,600 (73)
40	23,250 (24)		23,450 (42)	23,550 (51)	24,500 (57)	25,400 (61)	26,450 (64.5)	25,650 (67.5)	23,900 (69.5)	14,600 (71)
45	18,500 (21.5)		18,500 (33.5)	18,650 (45.5)	19,600 (52.5)	20,450 (57.5)	21,300 (61.5)	21,650 (64.5)	21,450 (67)	14,600 (68.5)
50	14,750 (21.5)		14,750 (39)	14,950 (47.5)	15,850 (53.5)	16,750 (58)	17,500 (61.5)	17,850 (64.5)	18,200 (66)	14,600 (66)
55	12,000 (31.5)		12,000 (42.5)	12,900 (49.5)	13,750 (54.5)	14,550 (58.5)	14,900 (62)	15,300 (64)	14,600 (64)	
60	9680 (20.5)		10,500 (36.5)	11,350 (45)	12,200 (51)	12,550 (55.5)	12,950 (59)	13,450 (61.5)	13,450 (61.5)	
65	8580 (29)		9400 (40)	10,250 (47)	10,650 (52)	11,050 (56)	11,450 (59)	11,850 (62)	11,450 (59)	
70	6950 (18.5)		7750 (34)	8620 (42.5)	9050 (48.5)	9460 (53)	9810 (56)	10,160 (59)	9810 (56)	
75	6350 (27.5)		7230 (38)	8080 (45)	8430 (50)	8830 (55)	9230 (60)	9630 (65)	8430 (53.5)	
80	5140 (17.5)		6040 (32.5)	6460 (41)	6880 (47)	7240 (52)	7540 (57)	7840 (62)	7240 (50.5)	
85	5010 (26)		5430 (36.5)	5840 (43)	6220 (49)	6510 (54)	6800 (59)	7090 (64)	6220 (47.5)	
90	4110 (17)		4520 (31)	4930 (39.5)	5320 (44)	5610 (49)	5900 (54)	6190 (59)	5320 (44)	
95	3730 (25)		4120 (35)	4510 (40.5)	4800 (45)	5090 (50)	5380 (55)	5670 (60)	4800 (45)	
100	3020 (16)		3410 (30)	3790 (36.5)	4170 (42)	4550 (48)	4930 (54)	5310 (60)	4170 (42)	
105	2770 (24)		3140 (32)	3510 (38)	3880 (44)	4250 (50)	4620 (56)	4990 (62)	3880 (44)	
110	2190 (16)		2560 (27)	2930 (33)	3300 (39)	3670 (45)	4040 (51)	4410 (57)	3300 (39)	
115	2040 (21)		2410 (27)	2780 (33)	3150 (39)	3520 (45)	3890 (51)	4260 (57)	3150 (39)	
120	1570 (10)		1940 (23)	2310 (29)	2680 (35)	3050 (41)	3420 (47)	3790 (53)	2680 (35)	

Minimum boom angle (°) for indicated length (no load) 9

Maximum boom length (ft) at 0° boom angle (no load) 120

#LMI operating code. Refer to LMI manual for instructions.

*This capacity is based upon maximum obtainable boom angle.

Note: () Boom angles are in degrees.

Lifting capacities at zero degree boom angle										
Boom angle	Main boom length in feet									
	41.3	50	60	**70	80	90	100	110	120	
0°	20,750 (34.1)	15,150 (42.8)	10,500 (52.8)	6700 (63)	5100 (72.8)	3900 (82.8)	2900 (92.8)	2000 (102.8)	1300 (112.8)	

Note: () Reference radii in feet.

**This boom length is with inner-mid fully extended and outer-mid & fly fully retracted.

A6-829-103751

Load charts



Pounds						
Feet	33 ft LENGTH			56 ft LENGTH		
	0° OFFSET	20° OFFSET	40° OFFSET	0° OFFSET	20° OFFSET	40° OFFSET
35	*11,900 (78)					
40	11,900 (75.5)			6060 (77.5)		
45	11,900 (73.5)	*11,600 (78)		6060 (76)		
50	11,900 (71.5)	10,600 (75)	*9700 (78)	6060 (74.5)		
55	11,900 (70)	9770 (73)	8470 (75.5)	6060 (73)		
60	11,000 (68)	9020 (71)	7920 (73.5)	6060 (71)	*6040 (78)	
65	10,000 (66)	8360 (69.5)	7430 (72)	6060 (69.5)	5900 (75)	
70	9190 (64)	7780 (67.5)	6980 (70)	6060 (68)	5730 (73.5)	*4930 (78)
75	8460 (62)	7260 (65.5)	6580 (68)	6060 (66)	5330 (71.5)	4640 (76)
80	7820 (60)	6790 (63.5)	6210 (65.5)	6040 (64.5)	4980 (70)	4370 (74)
85	7070 (58)	6370 (61)	5870 (63.5)	5570 (63)	4650 (68)	4120 (72)
90	6120 (55.5)	5990 (59)	5560 (61)	5150 (61)	4360 (66.5)	3890 (70)
95	5280 (53.5)	5640 (56.5)	5280 (59)	4780 (59.5)	4090 (64.5)	3680 (68.5)
100	4540 (51)	5100 (54.5)	5020 (56.5)	4440 (57.5)	3840 (62.5)	3480 (66.5)
105	3870 (48.5)	4360 (52)	4750 (54)	4130 (55.5)	3610 (60.5)	3300 (64.5)
110	3270 (46)	3710 (49.5)	4050 (51)	3720 (53.5)	3400 (58.5)	3130 (62.5)
115	2720 (43.5)	3110 (46.5)	3420 (48.5)	3200 (52)	3200 (56.5)	2970 (60)
120	2220 (40.5)	2570 (44)	2840 (45)	2730 (49.5)	3020 (54.5)	2820 (58)
125	1760 (37.5)	2070 (41)		2290 (47.5)	2840 (52.5)	2680 (55.5)
130	1340 (34)	1610 (37.5)		1900 (45.5)	2510 (50)	2540 (53)
135		1190 (34)		1530 (43)	2070 (48)	2410 (50.5)
140				1190 (40.5)	1670 (45)	1940 (47.5)
145					1300 (42.5)	
Minimum boom angle (°) for indicated length (no load)						
	30.5	32.5	43.5	38	39.5	46
Maximum boom length (ft) at 0° boom angle (no load)						
		100			90	

NOTE: () Boom angles are in degrees. A6-829-103773
 #LMI operating code. Refer to LMI manual for operating instructions.
 *This capacity is based upon maximum boom angle.

NOTES:

- All capacities above the bold line are based on structural strength of boom extension and do not exceed 85% of tipping loads, in accordance with SAE J-765.
- The 33 ft extension length may be used with single or double part line lifting service. The 56 ft extension length may be used for single line lifting service only.
- For main boom lengths less than 128 ft with the boom extension erected, the rated loads are determined by boom angle. Use only the column which corresponds to the boom extension length and offset for which the machine is set up. For boom angles not shown, use rating of the next lower boom angle.
- WARNING:** Operation of this machine with heavier loads than the capacities listed is strictly prohibited. Machine tipping with boom extension occurs rapidly and without advance warning.
- Boom angle is the angle above or below horizontal of the longitudinal axis of the boom base section after lifting rated load.
- Capacities listed are with outriggers properly extended and vertical jacks set only.
- When lifting over the main boom nose with 33 ft or 56 ft extension erected, the outriggers must be fully extended or 50% extended (15 ft 5 in spread).

THIS CHART IS ONLY A GUIDE AND SHOULD NOT BE USED TO OPERATE THE CRANE.

Load charts

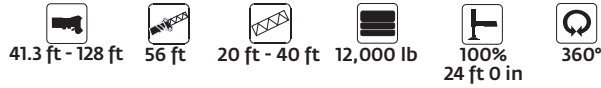

Pounds						
Feet	76 ft (56 ft LENGTH + 1 INSERT)			96 ft (56 ft LENGTH + 2 INSERTS)		
	0° OFFSET	20° OFFSET	40° OFFSET	0° OFFSET	20° OFFSET	40° OFFSET
50	4850 (77.5)					
55	4850 (76)			3520 (78)		
60	4850 (74.5)			3520 (77)		
65	4850 (73)	*5290 (78)		3520 (75.5)		
70	4850 (71.5)	4860 (76.5)		3520 (74)		
75	4850 (70)	4470 (75)		3520 (72.5)	3740 (77)	
80	4730 (68.5)	4110 (73.5)	4050 (77)	3520 (71.5)	3420 (75.5)	
85	4310 (67)	3790 (72)	3500 (75.5)	3300 (70)	3100 (74.5)	*3250 (78)
90	3940 (65.5)	3500 (70)	3260 (73.5)	2970 (68.5)	2820 (73)	2720 (76)
95	3610 (63.5)	3240 (68.5)	3030 (72)	2660 (67)	2560 (71.5)	2490 (74.5)
100	3310 (62)	3000 (67)	2830 (70.5)	2390 (65.5)	2320 (70)	2270 (73)
105	3040 (60.5)	2770 (65)	2630 (68.5)	2140 (64)	2100 (68.5)	2070 (71.5)
110	2790 (59)	2570 (63.5)	2450 (66.5)	1920 (62.5)	1900 (67)	1890 (70)
115	2560 (57)	2370 (61.5)	2280 (65)	1710 (61)	1710 (65.5)	1710 (68.5)
120	2350 (55.5)	2200 (60)	2120 (63)	1520 (59.5)	1540 (64)	1550 (66.5)
125	2160 (53.5)	2030 (58)	1970 (61)	1350 (58)	1380 (62.5)	1390 (65)
130	1990 (52)	1880 (56.5)	1830 (59)	1190 (56.5)	1230 (60.5)	1250 (63.5)
135	1670 (50)	1730 (54.5)	1700 (57)	1040 (55)	1080 (59)	1110 (61.5)
140	1320 (48)	1590 (52.5)	1570 (55)			
145		1470 (50.5)	1450 (52.5)			
150		1170 (48)	1340 (50.5)			
155			1100 (48)			
Minimum boom angle (°) for indicated length (no load)	46	46	46.5	53.5	58	60.5
Maximum boom length (ft) at 0° boom angle (no load)		70			60	

NOTE: () Boom angles are in degrees. A6-829-103787
 #LMI operating code. Refer to LMI manual for operating instructions.
 *This capacity is based upon maximum boom angle.

NOTES:

1. All capacities above the bold line are based on structural strength of boom extension and do not exceed 85% of tipping loads, in accordance with SAE J-765.

2. The 56 ft extension length may be used for single line lifting service only.

3. For main boom lengths less than 128 ft with the boom extension erected, the rated loads are determined by boom angle. Use only the column which corresponds to the boom extension length and offset for which the machine is set up. For boom angles not shown, use rating of the next lower boom angle.

4. **WARNING:** Operation of this machine with heavier loads than the capacities listed is strictly prohibited. Machine tipping with boom extension occurs rapidly and without advance warning.

5. Boom angle is the angle above or below horizontal of the longitudinal axis of the boom base section after lifting rated load.

6. Capacities listed are with outriggers properly extended and vertical jacks set only.

7. When lifting over the main boom nose with 56 ft extension erected and inserts, the outriggers must be fully extended and vertical jacks set.

Load charts

 41.3 ft - 128 ft
  10,000 lb
  100%
24 ft 0 in
  360°

Feet	Main boom length in feet									
	41.3	50	60	**70	80	90	100	110	120	128
8	++150,000 (73)									
9	++150,000 (71.5)	86,000 (75)								
10	144,500 (70)	86,000 (74)	86,000 (77)							
12	128,000 (67)	86,000 (71.5)	86,000 (75)	41,000 (77)						
15	109,500 (62)	86,000 (71.5)	86,000 (71.5)	41,000 (74.5)	39,000 (76.5)					
20	82,700 (53.5)	82,400 (61)	82,200 (66.5)	41,000 (70)	39,000 (73)	38,800 (75)	*38,700 (78)	*31,950 (78)		
25	54,550 (44)	54,600 (54)	54,150 (61)	41,000 (65.5)	39,000 (69)	38,800 (71.5)	38,700 (74)	31,950 (75.5)	*25,750 (78)	*14,600 (78)
30	38,450 (31)	38,650 (46.5)	38,600 (55.5)	38,300 (61)	39,000 (65)	38,800 (68.5)	36,150 (70.5)	31,950 (72.5)	25,750 (74.5)	14,600 (75.5)
35		28,800 (37)	28,950 (49.5)	28,850 (56.5)	29,800 (61)	30,750 (65)	31,350 (67.5)	29,300 (70)	25,750 (72)	14,600 (73)
40		22,100 (24)	22,300 (42)	22,400 (51)	23,300 (57)	24,200 (61)	25,250 (64.5)	25,500 (67.5)	23,900 (69.5)	14,600 (71)
45			17,500 (33.5)	17,650 (45.5)	18,600 (52.5)	19,450 (57.5)	20,300 (61.5)	20,600 (64.5)	20,900 (67)	14,600 (68.5)
50			13,850 (21.5)	14,050 (39)	14,950 (47.5)	15,850 (53.5)	16,600 (58)	16,950 (61.5)	17,300 (64.5)	14,600 (66)
55				11,200 (31.5)	12,100 (42.5)	12,950 (49.5)	13,750 (54.5)	14,100 (58.5)	14,500 (62)	14,600 (64)
60				8960 (20.5)	9810 (36.5)	10,650 (45)	11,450 (51)	11,850 (55.5)	12,250 (59)	12,700 (61.5)
65					7930 (29)	8740 (40)	9610 (47)	10,000 (52)	10,400 (56)	10,800 (59)
70					6350 (18.5)	7140 (34)	8020 (42.5)	8450 (48.5)	8850 (53)	9210 (56)
75						5790 (27.5)	6670 (38)	7100 (45)	7520 (50)	7870 (53.5)
80						4620 (17.5)	5520 (32.5)	5950 (41)	6360 (47)	6720 (50.5)
85							4520 (26)	4940 (36.5)	5350 (43)	5730 (47.5)
90							3650 (17)	4070 (31)	4470 (39.5)	4870 (44)
95								3300 (25)	3700 (35)	4080 (40.5)
100								2610 (16)	3000 (30)	3380 (36.5)
105									2390 (24)	2760 (32)
110									1830 (16)	2200 (27)
115										1700 (21)
120										1240 (10)

Minimum boom angle (°) for indicated length (no load). 9

Maximum boom length (ft) for 0° boom angle (no load). 120

#LMI operating code. Refer to LMI manual for instructions.

*This capacity is based upon maximum obtainable boom angle.

Note: () Boom angles are in degrees.

++9 parts of line required to lift this capacity (using aux. boom nose). Refer to Operator's & Safety Handbook for reeving diagram

Lifting capacities at zero degree boom angle

Boom angle	Main boom length in feet									
	41.3	50	60	**70	80	90	100	110	120	
0°	20,750 (34.1)	15,150 (42.8)	10,500 (52.8)	6700 (63)	5100 (72.8)	3900 (82.8)	2900 (92.8)	2000 (102.8)	1300 (112.8)	

Note: () Reference radii in feet.

**This boom length is with inner-mid fully extended and outer-mid & fly fully retracted.

A6-829-103752

THIS CHART IS ONLY A GUIDE AND SHOULD NOT BE USED TO OPERATE THE CRANE.

Load charts

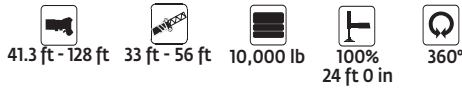

Pounds						
Feet	33 ft LENGTH			56 ft LENGTH		
	0° OFFSET	20° OFFSET	40° OFFSET	0° OFFSET	20° OFFSET	40° OFFSET
35	^o 11,900 (78)					
40	11,900 (75.5)			6060 (77.5)		
45	11,900 (73.5)	^o 11,600 (78)		6060 (76)		
50	11,900 (71.5)	10,600 (75)	^o 9700 (78)	6060 (74.5)		
55	11,900 (70)	9770 (73)	8470 (75.5)	6060 (73)		
60	11,000 (68)	9020 (71)	7920 (73.5)	6060 (71)	^o 6040 (78)	
65	10,000 (66)	8360 (69.5)	7430 (72)	6060 (69.5)	5900 (75)	
70	9190 (64)	7780 (67.5)	6980 (70)	6060 (68)	5730 (73.5)	^o 4930 (78)
75	8460 (62)	7260 (65.5)	6580 (68)	6060 (66)	5330 (71.5)	4640 (76)
80	7630 (60)	6790 (63.5)	6210 (65.5)	6040 (64.5)	4980 (70)	4370 (74)
85	6590 (58)	6370 (61)	5870 (63.5)	5570 (63)	4650 (68)	4120 (72)
90	5670 (55.5)	5990 (59)	5560 (61)	5150 (61)	4360 (66.5)	3890 (70)
95	4850 (53.5)	5480 (56.5)	5280 (59)	4780 (59.5)	4090 (64.5)	3680 (68.5)
100	4130 (51)	4690 (54.5)	5020 (56.5)	4440 (57.5)	3840 (62.5)	3480 (66.5)
105	3480 (48.5)	3980 (52)	4360 (54)	3910 (55.5)	3610 (60.5)	3300 (64.5)
110	2900 (46)	3340 (49.5)	3690 (51)	3350 (53.5)	3400 (58.5)	3130 (62.5)
115	2370 (43.5)	2760 (46.5)	3070 (48.5)	2850 (52)	3200 (56.5)	2970 (60)
120	1890 (40.5)	2240 (44)	2510 (45)	2390 (49.5)	3020 (54.5)	2820 (58)
125	1450 (37.5)	1760 (41)		1970 (47.5)	2670 (52.5)	2680 (55.5)
130	1040 (34)	1310 (37.5)		1590 (45.5)	2210 (50)	2540 (53)
135				1240 (43)	1780 (48)	2110 (50.5)
140					1390 (45)	1660 (47.5)
145					1030 (42.5)	
Minimum boom angle (°) for indicated length (no load)	33	34	43.5	40.5	41.5	46
Maximum boom length (ft) at 0° boom angle (no load)		100			80	

NOTE: () Boom angles are in degrees. A6-829-103774
 #LMI operating code. Refer to LMI manual for operating instructions.
 *This capacity is based upon maximum boom angle.

NOTES:

1. All capacities above the bold line are based on structural strength of boom extension and do not exceed 85% of tipping loads, in accordance with SAE J-765.

2. The 33 ft extension length may be used with single or double part line lifting service. The 56 ft extension length may be used for single line lifting service only.

3. For main boom lengths less than 128 ft with the boom extension erected, the rated loads are determined by boom angle. Use only the column which corresponds to the boom extension length and offset for which the machine is set up. For boom angles not shown, use rating of the next lower boom angle.

4. **WARNING:** Operation of this machine with heavier loads than the capacities listed is strictly prohibited. Machine tipping with boom extension occurs rapidly and without advance warning.

5. Boom angle is the angle above or below horizontal of the longitudinal axis of the boom base section after lifting rated load.

6. Capacities listed are with outriggers properly extended and vertical jacks set only.

7. When lifting over the main boom nose with 33 ft or 56 ft extension erected, the outriggers must be fully extended or 50% extended (15 ft 5 in spread).

Load charts

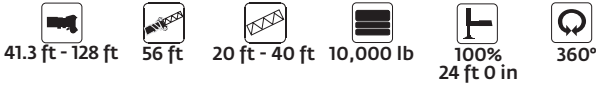

Pounds						
Feet	76 ft (56 ft + 1 INSERT)			96 ft (56 ft + 2 INSERTS)		
	0° OFFSET	20° OFFSET	40° OFFSET	0° OFFSET	20° OFFSET	40° OFFSET
50	4850 (77.5)					
55	4850 (76)			3520 (78)		
60	4850 (74.5)			3520 (77)		
65	4850 (73)	*5290 (78)		3520 (75.5)		
70	4850 (71.5)	4860 (76.5)		3520 (74)		
75	4850 (70)	4470 (75)		3520 (72.5)	3740 (77)	
80	4730 (68.5)	4110 (73.5)	4050 (77)	3520 (71.5)	3420 (75.5)	
85	4310 (67)	3790 (72)	3500 (75.5)	3300 (70)	3100 (74.5)	*3250 (78)
90	3940 (65.5)	3500 (70)	3260 (73.5)	2970 (68.5)	2820 (73)	2720 (76)
95	3610 (63.5)	3240 (68.5)	3030 (72)	2660 (67)	2560 (71.5)	2490 (74.5)
100	3310 (62)	3000 (67)	2830 (70.5)	2390 (65.5)	2320 (70)	2270 (73)
105	3040 (60.5)	2770 (65)	2630 (68.5)	2140 (64)	2100 (68.5)	2070 (71.5)
110	2790 (59)	2570 (63.5)	2450 (66.5)	1920 (62.5)	1900 (67)	1890 (70)
115	2560 (57)	2370 (61.5)	2280 (65)	1710 (61)	1710 (65.5)	1710 (68.5)
120	2350 (55.5)	2200 (60)	2120 (63)	1520 (59.5)	1540 (64)	1550 (66.5)
125	2150 (53.5)	2030 (58)	1970 (61)	1350 (58)	1380 (62.5)	1390 (65)
130	1750 (52)	1880 (56.5)	1830 (59)	1190 (56.5)	1230 (60.5)	1250 (63.5)
135	1380 (50)	1730 (54.5)	1700 (57)	1040 (55)	1080 (59)	1110 (61.5)
140	1040 (48)	1590 (52.5)	1570 (55)			
145		1240 (50.5)	1450 (52.5)			
150			1200 (50.5)			

Minimum boom angle (°) for indicated length (no load)

46.5	48	48	54	58	60.5
------	----	----	----	----	------

Maximum boom length (ft) at 0° boom angle (no load)

70	60
----	----

NOTE: () Boom angles are in degrees. #LMI operating code. Refer to LMI manual for operating instructions. *This capacity is based upon maximum boom angle.

NOTES:
 1. All capacities above the bold line are based on structural strength of boom extension and do not exceed 85% of tipping loads, in accordance with SAE J-765.

2. The 56 ft extension length may be used for single line lifting service only.

3. For main boom lengths less than 128 ft with the boom extension erected, the rated loads are determined by boom angle. Use only the column which corresponds to the boom extension length and offset for which the machine is set up. For boom angles not shown, use rating of the next lower boom angle.

4. **WARNING:** Operation of this machine with heavier loads than the capacities listed is strictly prohibited. Machine tipping with boom extension occurs rapidly and without advance warning.

5. Boom angle is the angle above or below horizontal of the longitudinal axis of the boom base section after lifting rated load.

6. Capacities listed are with outriggers properly extended and vertical jacks set only.

7. When lifting over the main boom nose with 56 ft extension erected and inserts, the outriggers must be fully extended and vertical jacks set.

Load charts

41.3 ft - 128 ft
 8000 lb
 100% 24 ft 0 in
 360°

Feet	Main boom length in feet									
	41.3	50	60	**70	80	90	100	110	120	128
8	++150,000 (73)									
9	++150,000 (71.5) 86,000 (75)									
10	143,500 (70) 86,000 (74) 86,000 (77)									
12	127,500 (67) 86,000 (71.5) 86,000 (75) 41,000 (77)									
15	109,000 (62) 86,000 (67.5) 86,000 (71.5) 41,000 (74.5) 39,000 (76.5)									
20	81,450 (53.5) 80,150 (61) 79,250 (66.5) 41,000 (70) 39,000 (73) 38,800 (75) *38,700 (78) *31,950 (78)									
25	52,250 (44) 52,300 (54) 51,850 (61) 41,000 (65.5) 39,000 (69) 38,800 (71.5) 38,700 (74) 31,950 (75.5) *25,750 (78) *14,600 (78)									
30	36,700 (31) 36,900 (46.5) 36,850 (55.5) 36,600 (61) 37,650 (65) 38,700 (68.5) 36,150 (70.5) 31,950 (72.5) 25,750 (74.5) 14,600 (75.5)									
35	27,400 (37) 27,400 (49.5) 27,500 (56.5) 27,450 (56.5) 28,400 (61) 29,350 (65) 30,850 (67.5) 29,300 (70) 25,750 (72) 14,600 (73)									
40	20,900 (24) 21,100 (42) 21,200 (51) 22,100 (57) 23,000 (61) 24,050 (64.5) 24,300 (67.5) 23,900 (69.5) 14,600 (71)									
45	16,450 (33.5) 16,450 (45.5) 16,600 (52.5) 17,600 (52.5) 18,400 (57.5) 19,300 (61.5) 19,600 (64.5) 19,900 (67) 14,600 (68.5)									
50	12,950 (21.5) 13,150 (39) 14,050 (47.5) 14,950 (53.5) 15,700 (58) 16,050 (61.5) 16,400 (64.5) 16,400 (66)									
55	10,400 (31.5) 11,300 (42.5) 12,150 (49.5) 12,950 (54.5) 13,300 (58.5) 13,700 (62) 14,300 (64)									
60	8240 (20.5) 9100 (36.5) 9930 (45) 10,750 (51) 11,150 (55.5) 11,500 (59) 12,000 (61.5)									
65	7270 (29) 8090 (40) 8960 (47) 9360 (52) 9740 (56) 10,150 (59)									
70	5750 (18.5) 6540 (34) 7420 (42.5) 7850 (48.5) 8250 (53) 8610 (56)									
75	5230 (27.5) 6120 (38) 6550 (45) 6960 (50) 7310 (53.5)									
80	4100 (17.5) 5000 (32.5) 5430 (41) 5840 (47) 6210 (50.5)									
85	4040 (26) 4460 (36.5) 4870 (43) 5250 (47.5)									
90	3200 (17) 3620 (31) 4020 (39.5) 4420 (44)									
95	2870 (25) 3270 (35) 3660 (40.5)									
100	2210 (16) 2600 (30) 2980 (36.5)									
105	2000 (24) 2380 (32)									
110	1470 (16) 1840 (27)									
115	1350 (21)									

Minimum boom angle (°) for indicated length (no load). 9
 Maximum boom length (ft) at 0° boom angle (no load). 102

#LMI operating code. Refer to LMI manual for instructions.

**This capacity is based upon maximum obtainable boom angle.

Note: () Boom angles are in degrees.

++9 parts of line required to lift this capacity (using aux. boom nose). Refer to Operator's & Safety Handbook for reeving diagram

Lifting capacities at zero degree boom angle

Boom angle	Main boom length in feet								
	41.3	50	60	**70	80	90	100	110	120
0°	20,750 (34.1)	15,150 (42.8)	10,500 (52.8)	6700 (63)	5000 (72.8)	3540 (82.8)	2780 (92.8)	1870 (102.8)	1190 (112.8)

Note: () Reference radii in feet.

**This boom length is with inner-mid fully extended and outer-mid & fly fully retracted.

A6-829-103753

Load charts



Pounds						
Feet	33 ft LENGTH			56 ft LENGTH		
	0° OFFSET	20° OFFSET	40° OFFSET	0° OFFSET	20° OFFSET	40° OFFSET
35	[*] 11,900 (78)					
40	11,900 (75.5)			6060 (77.5)		
45	11,900 (73.5)	[*] 11,600 (78)		6060 (76)		
50	11,900 (71.5)	10,600 (75)	[*] 9700 (78)	6060 (74.5)		
55	11,900 (70)	9770 (73)	8470 (75.5)	6060 (73)		
60	11,000 (68)	9020 (71)	7920 (73.5)	6060 (71)	[*] 6040 (78)	
65	10,000 (66)	8360 (69.5)	7430 (72)	6060 (69.5)	5900 (75)	
70	9190 (64)	7780 (67.5)	6980 (70)	6060 (68)	5730 (73.5)	[*] 4930 (78)
75	8280 (62)	7260 (65.5)	6580 (68)	6060 (66)	5330 (71.5)	4640 (76)
80	7120 (60)	6790 (63.5)	6210 (65.5)	6040 (64.5)	4980 (70)	4370 (74)
85	6100 (58)	6370 (61)	5870 (63.5)	5570 (63)	4650 (68)	4120 (72)
90	5210 (55.5)	5920 (59)	5560 (61)	5150 (61)	4360 (66.5)	3890 (70)
95	4430 (53.5)	5050 (56.5)	5280 (59)	4780 (59.5)	4090 (64.5)	3680 (68.5)
100	3730 (51)	4290 (54.5)	4720 (56.5)	4120 (57.5)	3840 (62.5)	3480 (66.5)
105	3100 (48.5)	3600 (52)	3980 (54)	3530 (55.5)	3610 (60.5)	3300 (64.5)
110	2540 (46)	2980 (49.5)	3320 (51)	2990 (53.5)	3400 (58.5)	3130 (62.5)
115	2030 (43.5)	2420 (46.5)	2720 (48.5)	2510 (52)	3200 (56.5)	2970 (60)
120	1560 (40.5)	1910 (44)	2180 (45)	2060 (49.5)	2840 (54.5)	2820 (58)
125	1130 (37.5)	1440 (41)		1660 (47.5)	2350 (52.5)	2680 (55.5)
130		1010 (37.5)		1290 (45.5)	1900 (50)	2310 (53)
135					1490 (48)	1820 (50.5)
140					1110 (45)	1380 (47.5)
Minimum boom angle (°) for indicated length (no load)	36.5	36.5	4.35	43	44	46
Maximum boom length (ft) at 0° boom angle (no load)		90			80	

NOTE: () Boom angles are in degrees. A6-829-103775
 #LMI operating code. Refer to LMI manual for operating instructions.
^{*}This capacity is based upon maximum boom angle.

NOTES:

1. All capacities above the bold line are based on structural strength of boom extension and do not exceed 85% of tipping loads, in accordance with SAE J-765.

2. The 33 ft extension length may be used with single or double part line lifting service. The 56 ft extension length may be used for single line lifting service only.

3. For main boom lengths less than 128 ft with the boom extension erected, the rated loads are determined by boom angle. Use only the column which corresponds to the boom extension length and offset for which the machine is set up. For boom angles not shown, use rating of the next lower boom angle.

4. **WARNING:** Operation of this machine with heavier loads than the capacities listed is strictly prohibited. Machine tipping with boom extension occurs rapidly and without advance warning.

5. Boom angle is the angle above or below horizontal of the longitudinal axis of the boom base section after lifting rated load.

6. Capacities listed are with outriggers properly extended and vertical jacks set only.

7. When lifting over the main boom nose with 33 ft or 56 ft extension erected, the outriggers must be fully extended or 50% extended (15 ft 5 in spread).

Load charts

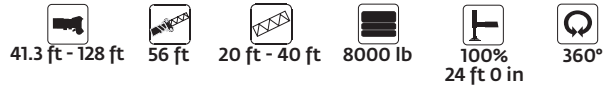

Pounds						
Feet	76 ft (56 ft LENGTH + 1 INSERT)			96 ft (56 ft LENGTH + 2 INSERTS)		
	0° OFFSET	20° OFFSET	40° OFFSET	0° OFFSET	20° OFFSET	40° OFFSET
50	4850 (77.5)					
55	4850 (76)			3520 (78)		
60	4850 (74.5)			3520 (77)		
65	4850 (73)	*5290 (78)		3520 (75.5)		
70	4850 (71.5)	4860 (76.5)		3520 (74)		
75	4850 (70)	4470 (75)		3520 (72.5)	3740 (77)	
80	4730 (68.5)	4110 (73.5)	4050 (77)	3520 (71.5)	3420 (75.5)	
85	4310 (67)	3790 (72)	3500 (75.5)	3300 (70)	3100 (74.5)	*3250 (78)
90	3940 (65.5)	3500 (70)	3260 (73.5)	2970 (68.5)	2820 (73)	2720 (76)
95	3610 (63.5)	3240 (68.5)	3030 (72)	2660 (67)	2560 (71.5)	2490 (74.5)
100	3310 (62)	3000 (67)	2830 (70.5)	2390 (65.5)	2320 (70)	2270 (73)
105	3040 (60.5)	2770 (65)	2630 (68.5)	2140 (64)	2100 (68.5)	2070 (71.5)
110	2790 (59)	2570 (63.5)	2450 (66.5)	1920 (62.5)	1900 (67)	1890 (70)
115	2560 (57)	2370 (61.5)	2280 (65)	1710 (61)	1710 (65.5)	1710 (68.5)
120	2250 (55.5)	2200 (60)	2120 (63)	1520 (59.5)	1540 (64)	1550 (66.5)
125	1840 (53.5)	2030 (58)	1970 (61)	1350 (58)	1380 (62.5)	1390 (65)
130	1460 (52)	1880 (56.5)	1830 (59)	1190 (56.5)	1230 (60.5)	1250 (63.5)
135	1110 (50)	1700 (54.5)	1700 (57)		1080 (59)	1110 (61.5)
140		1320 (52.5)	1570 (55)			
145			1300 (52.5)			
Minimum boom angle (°) for indicated length (no load)	48.5	50.5	50.5	55	58	60.5
Maximum boom length (ft) at 0° boom angle (no load)		60			60	

NOTE: () Boom angles are in degrees. A6-829-103789
 #LMI operating code. Refer to LMI manual for operating instructions.
 *This capacity is based upon maximum boom angle.

NOTES:

- All capacities above the bold line are based on structural strength of boom extension and do not exceed 85% of tipping loads, in accordance with SAE J-765.
- The 56 ft extension length may be used for single line lifting service only.
- For main boom lengths less than 128 ft with the boom extension erected, the rated loads are determined by boom angle. Use only the column which corresponds to the boom extension length and offset for which the machine is set up. For boom angles not shown, use rating of the next lower boom angle.
- WARNING:** Operation of this machine with heavier loads than the capacities listed is strictly prohibited. Machine tipping with boom extension occurs rapidly and without advance warning.
- Boom angle is the angle above or below horizontal of the longitudinal axis of the boom base section after lifting rated load.
- Capacities listed are with outriggers properly extended and vertical jacks set only.
- When lifting over the main boom nose with 56 ft extension erected and inserts, the outriggers must be fully extended and vertical jacks set.

Load charts

 41.3 ft - 128 ft
  4000 lb
  100%
 24 ft 0 in
  360°

Feet	Main boom length in feet									
	41.3	50	60	**70	80	90	100	110	120	128
8	++150,000 (73)									
9	++150,000 (71.5) 86,000 (75)									
10	142,500 (70)	86,000 (74)	86,000 (77)							
12	126,500 (67)	86,000 (71.5)	86,000 (75)	41,000 (77)						
15	108,000 (62)	86,000 (67.5)	86,000 (71.5)	41,000 (74.5)	39,000 (76.5)					
20	75,150 (53.5)	73,500 (61)	72,600 (66.5)	41,000 (70)	39,000 (73)	38,800 (75)	*38,700 (78)	*31,950 (78)		
25	47,700 (44)	47,750 (54)	47,300 (61)	41,000 (65.5)	39,000 (69)	38,800 (71.5)	38,700 (74)	31,950 (75.5)	*25,750 (78)	*14,600 (78)
30	33,200 (31)	33,400 (46.5)	33,400 (55.5)	33,100 (61)	34,150 (65)	35,250 (68.5)	36,150 (70.5)	31,950 (72.5)	25,750 (74.5)	14,600 (75.5)
35		24,550 (37)	24,700 (49.5)	24,650 (56.5)	25,550 (61)	26,550 (65)	28,050 (67.5)	28,100 (70)	25,750 (72)	14,600 (73)
40		18,550 (24)	18,750 (42)	18,850 (51)	19,750 (57)	20,650 (61)	21,700 (64.5)	21,950 (67.5)	22,150 (69.5)	14,600 (71)
45			14,450 (33.5)	14,550 (45.5)	15,550 (52.5)	16,400 (57.5)	17,250 (61.5)	17,550 (64.5)	17,850 (67)	14,600 (68.5)
50			11,150 (21.5)	11,350 (39)	12,250 (47.5)	13,150 (53.5)	13,900 (58)	14,250 (61.5)	14,600 (64.5)	14,600 (66)
55				8830 (31.5)	9720 (42.5)	10,550 (49.5)	11,350 (54.5)	11,700 (58.5)	12,100 (62)	12,700 (64)
60				6800 (20.5)	7650 (36.5)	8490 (45)	9320 (51)	9710 (55.5)	10,050 (59)	10,550 (61.5)
65					5960 (29)	6770 (40)	7660 (47)	8040 (52)	8430 (56)	8840 (59)
70					4540 (18.5)	5340 (34)	6220 (42.5)	6650 (48.5)	7050 (53)	7400 (56)
75						4120 (27.5)	5010 (38)	5440 (45)	5850 (50)	6200 (53.5)
80						3070 (17.5)	3970 (32.5)	4400 (41)	4810 (47)	5170 (50.5)
85							3080 (26)	3500 (36.5)	3910 (43)	4280 (47.5)
90							2300 (17)	2710 (31)	3110 (39.5)	3510 (44)
95								2020 (25)	2420 (35)	2810 (40.5)
100								1400 (16)	1790 (30)	2170 (36.5)
105									1240 (24)	1580 (32)
110										1050 (27)
Minimum boom angle (°) for indicated length (no load).									23	26
Maximum boom length (ft) at 0° boom angle (no load).										110

#LMI operating code. Refer to LMI manual for instructions.
 *This capacity is based upon maximum obtainable boom angle.
 Note: () Boom angles are in degrees.

++9 parts of line required to lift this capacity (using aux. boom nose). Refer to Operator's & Safety Handbook for reeving diagram

Lifting capacities at zero degree boom angle

Boom angle	Main boom length in feet									
	41.3	50	60	**70	80	90	100	110		
0°	20,750 (34.1)	15,150 (42.8)	9680 (52.8)	5760 (63)	3850 (72.8)	2550 (82.8)	1900 (92.8)	1090 (102.8)		

Note: () Reference radii in feet.

**This boom length is with inner-mid fully extended and outer-mid & fly fully retracted.

A6-829-103754

Load charts

 41.3 ft - 128 ft
  33 ft - 56 ft
  4000 lb
  100%
  360°
 24 ft 0 in

Pounds						
Feet	33 ft LENGTH			56 ft LENGTH		
	0° OFFSET	20° OFFSET	40° OFFSET	0° OFFSET	20° OFFSET	40° OFFSET
35	[*] 11,900 (78)					
40	11,900 (75.5)			6060 (77.5)		
45	11,900 (73.5)	[*] 11,600 (78)		6060 (76)		
50	11,900 (71.5)	10,600 (75)	^o 9700 (78)	6060 (74.5)		
55	11,900 (70)	9770 (73)	8470 (75.5)	6060 (73)		
60	11,000 (68)	9020 (71)	7920 (73.5)	6060 (71)	[*] 6040 (78)	
65	9930 (66)	8360 (69.5)	7430 (72)	6060 (69.5)	5900 (75)	
70	8440 (64)	7780 (67.5)	6980 (70)	6060 (68)	5730 (73.5)	[*] 4930 (78)
75	7170 (62)	7260 (65.5)	6580 (68)	6060 (66)	5330 (71.5)	4640 (76)
80	6080 (60)	6790 (63.5)	6210 (65.5)	6040 (64.5)	4980 (70)	4370 (74)
85	5140 (58)	5870 (61)	5870 (63.5)	5570 (63)	4650 (68)	4120 (72)
90	4310 (55.5)	4970 (59)	5540 (61)	4900 (61)	4360 (66.5)	3890 (70)
95	3570 (53.5)	4180 (56.5)	4680 (59)	4160 (59.5)	4090 (64.5)	3680 (68.5)
100	2920 (51)	3480 (54.5)	3910 (56.5)	3470 (57.5)	3840 (62.5)	3480 (66.5)
105	2340 (48.5)	2830 (52)	3220 (54)	2850 (55.5)	3610 (60.5)	3300 (64.5)
110	1810 (46)	2250 (49.5)	2590 (51)	2300 (53.5)	3180 (58.5)	3130 (62.5)
115	1330 (43.5)	1720 (46.5)	2030 (48.5)	1820 (52)	2640 (56.5)	2970 (60)
120		1240 (44)	1520 (45)	1400 (49.5)	2150 (54.5)	2740 (58)
125				1020 (47.5)	1710 (52.5)	2200 (55.5)
130					1300 (50)	1700 (53)
135						1240 (50.5)
Minimum boom angle (°) for indicated length (no load)						
	40.5	42.5	43.5	46.5	48	49
Maximum boom length (ft) at 0° boom angle (no load)						
		80			70	

NOTE: () Boom angles are in degrees. A6-829-103776
[#]LMI operating code. Refer to LMI manual for operating instructions.
^{*}This capacity is based upon maximum boom angle.

NOTES:

1. All capacities above the bold line are based on structural strength of boom extension and do not exceed 85% of tipping loads, in accordance with SAE J-765.

2. The 33 ft extension length may be used with in-gle or double part line lifting service. The 56 ft extension length may be used for single line lifting service only.

3. For main boom lengths less than 128 ft with the boom extension erected, the rated loads are determined by boom angle. Use only the column which corresponds to the boom extension length and offset for which the machine is set up. For boom angles not shown, use rating of the next lower boom angle.

4. WARNING: Operation of this machine with heavier loads than the capacities listed is strictly prohibited. Machine tipping with boom extension occurs rapidly and without advance warning.

5. Boom angle is the angle above or below horizontal of the longitudinal axis of the boom base section after lifting rated load.

6. Capacities listed are with outriggers properly extended and vertical jacks set only.

7. When lifting over the main boom nose with 33 ft or 56 ft extension erected, the outriggers must be fully extended or 50% extended (15 ft 5 in spread).

Load charts



Pounds						
Feet	76 ft (56 ft LENGTH + 1 INSERT)			96 ft (56 ft LENGTH + 2 INSERTS)		
	0° OFFSET	20° OFFSET	40° OFFSET	0° OFFSET	20° OFFSET	40° OFFSET
50	4850 (77.5)					
55	4850 (76)			3520 (78)		
60	4850 (74.5)			3520 (77)		
65	4850 (73)	*5290 (78)		3520 (75.5)		
70	4850 (71.5)	4860 (76.5)		3520 (74)		
75	4850 (70)	4470 (75)		3520 (72.5)	3740 (77)	
80	4730 (68.5)	4110 (73.5)	4050 (77)	3520 (71.5)	3420 (75.5)	
85	4310 (67)	3790 (72)	3500 (75.5)	3300 (70)	3100 (74.5)	*3250 (78)
90	3940 (65.5)	3500 (70)	3260 (73.5)	2970 (68.5)	2820 (73)	2720 (76)
95	3610 (63.5)	3240 (68.5)	3030 (72)	2660 (67)	2560 (71.5)	2490 (74.5)
100	3310 (62)	3000 (67)	2830 (70.5)	2390 (65.5)	2320 (70)	2270 (73)
105	3040 (60.5)	2770 (65)	2630 (68.5)	2140 (64)	2100 (68.5)	2070 (71.5)
110	2580 (59)	2570 (63.5)	2450 (66.5)	1920 (62.5)	1900 (67)	1890 (70)
115	2070 (57)	2370 (61.5)	2280 (65)	1710 (61)	1710 (65.5)	1710 (68.5)
120	1600 (55.5)	2200 (60)	2120 (63)	1320 (59.5)	1540 (64)	1550 (66.5)
125	1180 (53.5)	1970 (58)	1970 (61)		1380 (62.5)	1390 (65)
130		1510 (56.5)	1830 (59)		1230 (60.5)	1250 (63.5)
135		1090 (54.5)	1520 (57)			1110 (61.5)
140			1130 (55)			
Minimum boom angle (°) for indicated length (no load)	52.5	53	53.5	58	59	60.5
Maximum boom length (ft) at 0° boom angle (no load)		60		50		

NOTE: () Boom angles are in degrees. A6-829-103790
 #LMI operating code. Refer to LMI manual for operating instructions.
 *This capacity is based upon maximum boom angle.

NOTES:

1. All capacities above the bold line are based on structural strength of boom extension and do not exceed 85% of tipping loads, in accordance with SAE J-765.

2. The 56 ft extension length may be used for single line lifting service only.

3. For main boom lengths less than 128 ft with the boom extension erected, the rated loads are determined by boom angle. Use only the column which corresponds to the boom extension length and offset for which the machine is set up. For boom angles not shown, use rating of the next lower boom angle.

4. **WARNING:** Operation of this machine with heavier loads than the capacities listed is strictly prohibited. Machine tipping with boom extension occurs rapidly and without advance warning.

5. Boom angle is the angle above or below horizontal of the longitudinal axis of the boom base section after lifting rated load.

6. Capacities listed are with outriggers properly extended and vertical jacks set only.

7. When lifting over the main boom nose with 56 ft extension erected and inserts, the outriggers must be fully extended and vertical jacks set.

Load charts

 41.3 ft - 128 ft
 0 lb
 100%
 360°
 24 ft 0 in

Feet	Main boom length in feet									
	41.3	50	60	**70	80	90	100	110	120	128
8	++150,000 (73)									
9	++150,000 (71.5)	86,000 (75)								
10	141,500 (70)	86,000 (74)	86,000 (77)							
12	125,500 (67)	86,000 (71.5)	86,000 (75)	41,000 (77)						
15	105,500 (62)	86,000 (67.5)	86,000 (71.5)	41,000 (74.5)	39,000 (76.5)					
20	68,500 (53.5)	66,950 (61)	66,050 (66.5)	41,000 (70)	39,000 (73)	38,800 (75)	*38,700 (78)	*31,950 (78)		
25	43,100 (44)	43,150 (54)	42,700 (61)	41,000 (65.5)	39,000 (69)	38,800 (71.5)	38,700 (74)	31,950 (75.5)	*25,750 (78)	*14,600 (78)
30	29,700 (31)	29,950 (46.5)	29,900 (55.5)	29,600 (61)	30,650 (65)	31,750 (68.5)	34,200 (70.5)	31,950 (72.5)	25,750 (74.5)	14,600 (75.5)
35		21,750 (37)	21,850 (49.5)	21,800 (56.5)	22,750 (61)	23,700 (65)	25,200 (67.5)	25,550 (70)	25,750 (72)	14,600 (73)
40		16,150 (24)	16,350 (42)	16,450 (51)	17,400 (57)	18,250 (61)	19,350 (64.5)	19,800 (67.5)	20,250 (69.5)	14,600 (71)
45			12,400 (33.5)	12,550 (45.5)	13,500 (52.5)	14,350 (57.5)	15,200 (61.5)	15,650 (64.5)	16,150 (67)	14,600 (68.5)
50			9390 (21.5)	9570 (39)	10,450 (47.5)	11,350 (53.5)	12,100 (58)	12,600 (61.5)	13,100 (64.5)	13,600 (66)
55				7230 (31.5)	8120 (42.5)	8990 (49.5)	9770 (54.5)	10,200 (58.5)	10,700 (62)	11,100 (64)
60				5360 (20.5)	6210 (36.5)	7050 (45)	7880 (51)	8330 (55.5)	8790 (59)	9130 (61.5)
65					4640 (29)	5460 (40)	6340 (47)	6780 (52)	7210 (56)	7520 (59)
70					3330 (18.5)	4130 (34)	5020 (42.5)	5480 (48.5)	5900 (53)	6200 (56)
75						3000 (27.5)	3900 (38)	4340 (45)	4760 (50)	5080 (53.5)
80						2030 (17.5)	2940 (32.5)	3370 (41)	3780 (47)	4110 (50.5)
85							2110 (26)	2520 (36.5)	2920 (43)	3260 (47.5)
90							1390 (17)	1780 (31)	2170 (39.5)	2510 (44)
95								1130 (25)	1500 (35)	1820 (40.5)
100										1220 (36.5)

Minimum boom angle (°) for indicated length (no load). 24 29 35

Maximum boom length (ft) at 0° boom angle (no load). 100

#LMI operating code. Refer to LMI manual for instructions.

**This capacity is based upon maximum obtainable boom angle.

Note: () Boom angles are in degrees.

++9 parts of line required to lift this capacity (using aux. boom nose). Refer to Operator's & Safety Handbook for reeving diagram

Lifting capacities at zero degree boom angle

Boom angle	Main boom length in feet						
	41.3	50	60	**70	80	90	110
0°	20,750 (34.1)	13,750 (42.8)	8000 (52.8)	4390 (63)	2690 (72.8)	1550 (82.8)	1030 (92.8)

Note: () Reference radii in feet.

**This boom length is with inner-mid fully extended and outer-mid & fly fully retracted.

A6-829-103755

Load charts

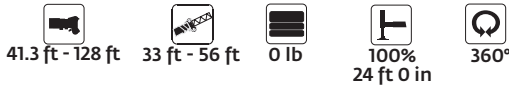

Pounds						
Feet	33 ft LENGTH			56 ft LENGTH		
	0° OFFSET	20° OFFSET	40° OFFSET	0° OFFSET	20° OFFSET	40° OFFSET
35	*11,900 (78)					
40	11,900 (75.5)			6060 (77.5)		
45	11,900 (73.5)	*11,600 (78)		6060 (76)		
50	11,900 (71.5)	10,600 (75)	*9700 (78)	6060 (74.5)		
55	11,900 (70)	9770 (73)	8470 (75.5)	6060 (73)		
60	10,050 (68)	9020 (71)	7920 (73.5)	6060 (71)	*6040 (78)	
65	8410 (66)	8360 (69.5)	7430 (72)	6060 (69.5)	5900 (75)	
70	7010 (64)	7640 (67.5)	6980 (70)	6060 (68)	5730 (73.5)	*4930 (78)
75	5840 (62)	6460 (65.5)	6580 (68)	6030 (66)	5330 (71.5)	4640 (76)
80	4840 (60)	5440 (63.5)	6070 (65.5)	5110 (64.5)	4980 (70)	4370 (74)
85	3980 (58)	4560 (61)	5120 (63.5)	4310 (63)	4650 (68)	4120 (72)
90	3230 (55.5)	3780 (59)	4290 (61)	3610 (61)	4360 (66.5)	3890 (70)
95	2570 (53.5)	3100 (56.5)	3560 (59)	3000 (59.5)	4000 (64.5)	3680 (68.5)
100	1990 (51)	2490 (54.5)	2910 (56.5)	2440 (57.5)	3380 (62.5)	3480 (66.5)
105	1460 (48.5)	1940 (52)	2320 (54)	1950 (55.5)	2810 (60.5)	3300 (64.5)
110		1440 (49.5)	1740 (51)	1510 (53.5)	2310 (58.5)	2920 (62.5)
115			1220 (48.5)	1100 (52)	1850 (56.5)	2380 (60)
120					1430 (54.5)	1900 (58)
125					1040 (52.5)	1460 (55.5)
130						1020 (53)
Minimum boom angle (°) for indicated length (no load)	46	46.5	47.5	51	51.5	52
Maximum boom length (ft) at 0° boom angle (no load)		70		60		

NOTE: () Boom angles are in degrees. A6-829-103777
 #LMI operating code. Refer to LMI manual for operating instructions.
 *This capacity is based upon maximum boom angle.

NOTES:

1. All capacities above the bold line are based on structural strength of boom extension and do not exceed 85% of tipping loads, in accordance with SAE J-765.

2. The 33 ft extension length may be used with single or double part line lifting service. The 56 ft extension length may be used for single line lifting service only.

3. For main boom lengths less than 128 ft with the boom extension erected, the rated loads are determined by boom angle. Use only the column which corresponds to the boom extension length and offset for which the machine is set up. For boom angles not shown, use rating of the next lower boom angle.

4. WARNING: Operation of this machine with heavier loads than the capacities listed is strictly prohibited. Machine tipping with boom extension occurs rapidly and without advance warning.

5. Boom angle is the angle above or below horizontal of the longitudinal axis of the boom base section after lifting rated load.

6. Capacities listed are with outriggers properly extended and vertical jacks set only.

7. When lifting over the main boom nose with 33 ft or 56 ft extension erected, the outriggers must be fully extended or 50% extended (15 ft 5 in spread).

Load charts

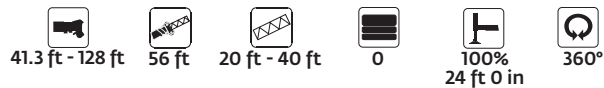

Pounds						
Feet	76 ft (56 ft LENGTH + 1 INSERT)			96 ft (56 ft LENGTH + 2 INSERTS)		
	0° OFFSET	20° OFFSET	40° OFFSET	0° OFFSET	20° OFFSET	40° OFFSET
50	4850 (77.5)					
55	4850 (76)			3520 (78)		
60	4850 (74.5)			3520 (77)		
65	4850 (73)	*5290 (78)		3520 (75.5)		
70	4850 (71.5)	4860 (76.5)		3520 (74)		
75	4850 (70)	4470 (75)		3520 (72.5)	3740 (77)	
80	4730 (68.5)	4110 (73.5)	4050 (77)	3520 (71.5)	3420 (75.5)	
85	4310 (67)	3790 (72)	3500 (75.5)	3300 (70)	3100 (74.5)	*3250 (78)
90	3700 (65.5)	3500 (70)	3260 (73.5)	2970 (68.5)	2820 (73)	2720 (76)
95	3100 (63.5)	3240 (68.5)	3030 (72)	2660 (67)	2560 (71.5)	2490 (74.5)
100	2560 (62)	3000 (67)	2830 (70.5)	2390 (65.5)	2320 (70)	2270 (73)
105	2080 (60.5)	2770 (65)	2630 (68.5)	1920 (64)	2100 (68.5)	2070 (71.5)
110	1640 (59)	2410 (63.5)	2450 (66.5)	1460 (62.5)	1900 (67)	1890 (70)
115	1240 (57)	1980 (61.5)	2280 (65)	1030 (61)	1710 (65.5)	1710 (68.5)
120		1580 (60)	2050 (63)		1490 (64)	1550 (66.5)
125		1210 (58)	1640 (61)		1080 (62.5)	1390 (65)
130			1260 (59)			1250 (63.5)
Minimum boom angle (°) for indicated length (no load)	55.5	56.5	57	60	61.5	61.5
Maximum boom length (ft) at 0° boom angle (no load)	60			50		

NOTE: () Boom angles are in degrees. A6-829-103791
 #LMI operating code. Refer to LMI manual for operating instructions.
 *This capacity is based upon maximum boom angle.

NOTES:

- All capacities above the bold line are based on structural strength of boom extension and do not exceed 85% of tipping loads, in accordance with SAE J-765.
- The 56 ft extension length may be used for single line lifting service only.
- For main boom lengths less than 128 ft with the boom extension erected, the rated loads are determined by boom angle. Use only the column which corresponds to the boom extension length and offset for which the machine is set up. For boom angles not shown, use rating of the next lower boom angle.
- WARNING: Operation of this machine with heavier loads than the capacities listed is strictly prohibited. Machine tipping with boom extension occurs rapidly and without advance warning.
- Boom angle is the angle above or below horizontal of the longitudinal axis of the boom base section after lifting rated load.
- Capacities listed are with outriggers properly extended and vertical jacks set only.
- When lifting over the main boom nose with 56 ft extension erected and inserts, the outriggers must be fully extended and vertical jacks set.

Load handling

Weight reductions for load handling devices

33 ft-56 ft folding boom extension

*33 ft extension (erected)	5590 lb
*56 ft extension (erected)	13,060 lb
*76 ft extension (1 insert erected)	13,670 lb
*96 ft extension (2 inserts erected)	20,680 lb

*Reduction of main boom capacities
(no deduct required for stowed boom extension)

When lifting over swingaway and/or jib combinations, deduct total weight of all load handling devices reeved over main boom nose directly from swingaway or jib capacity.

Auxiliary boom nose	136 lb
---------------------	--------

Hookblocks and headache balls:

75 Ust, 4 sheave	1275 lb +
40 Ust, 3 sheave	823 lb +
10 Ust, overhaul ball	568 lb +

+ Refer to rating plate for actual weight.

NOTE: All load handling devices and boom attachments are considered part of the load and suitable allowances MUST BE MADE for their combined weights. Weights are for Grove furnished equipment.

Boom section vs. section extension percentages

	Main boom length in feet										
	41.3	50	60	70	80	90	100	110	120	128	
Boom sections:	Percent extension										
Inner-mid	0	30	65	100	100	100	100	100	100	100	100
Outer-mid	0	0	0	0	7	34	52	69	86	100	
Fly	0	0	0	0	17	34	52	69	86	100	

Line pulls and reeving information

Hoists	Cable/Specs.	Permissible	Nominal
		Line pulls	Cable length
	3/4 in (19 mm) 6x37 Class,		
Main	EIPS, IWRC Special Flexible Min. Breaking Strength 58,800 lb	16,800 lb	600 ft
	19 mm (.75 in) Flex-X 35		
Main & Aux	Rotation resistant (non-rotating) Min breaking strength 85,800 lb	16,800 lb	607 ft

The approximate weight of 3/4 in wire rope is 1.5 lb/ft

Hoist performance

Wire Rope Layer	Hoist line pulls		Drum rope Capacity (ft)	
	Two speed hoist		Layer	Total
	Low	High		
	Available lb*	Available lb*		
1	20,250	9610	101	101
2	18,490	8770	110	211
3	17,010	8070	120	331
4	15,750	7470	129	460
5	14,660	6960	139	599

*Max. lifting capacity: 6x37 or 35x7 class = 17,160 lb

Working area diagram

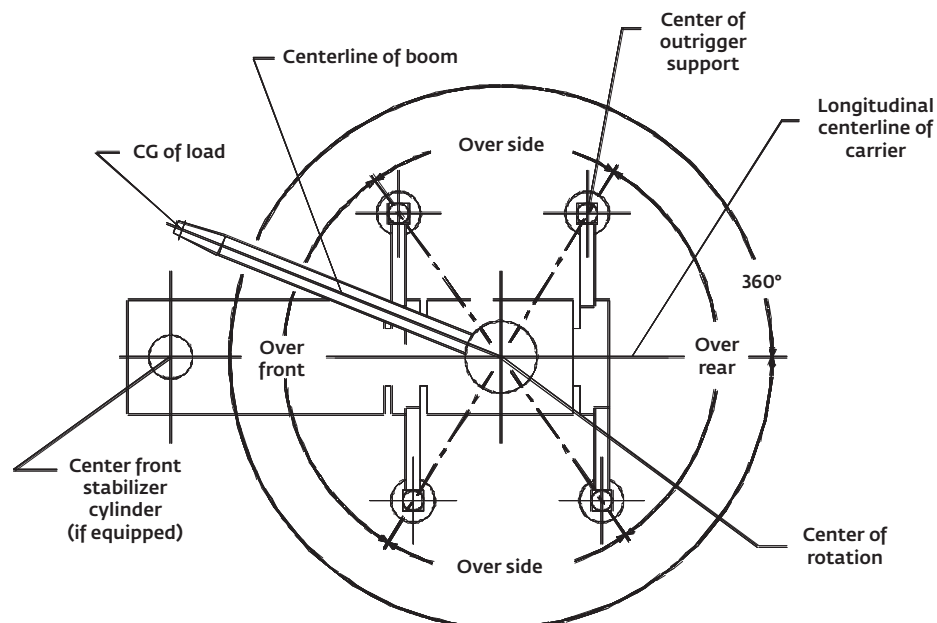

6-829-005671

Bold lines determine the limiting position of any load for operation within working areas indicated.

THIS CHART IS ONLY A GUIDE AND SHOULD NOT BE USED TO OPERATE THE CRANE.

Grove TMS800E *The individual crane's load chart, operating instructions and other instructional plates must be read and understood prior to operating the crane.*

Manitowoc Cranes

Regional headquarters

Americas

Manitowoc, Wisconsin, USA

Tel: +1 920 684 6621

Fax: +1 920 683 6277

Shady Grove, Pennsylvania, USA

Tel: +1 717 597 8121

Fax: +1 717 597 4062

Europe, Middle East, Africa

Ecully, France

Tel: +33 (0)4 72 18 20 20

Fax: +33 (0)4 72 18 20 00

China

Shanghai, China

Tel: +86 21 6457 0066

Fax: +86 21 6457 4955

Greater Asia-Pacific

Singapore

Tel: +65 6264 1188

Fax: +65 6862 4040

Regional offices

Americas

Brazil

Alphaville

Mexico

Monterrey

Chile

Santiago

Europe, Middle East, Africa

Czech Republic

Netvorice

France

Baudemont

Cergy

Decines

Germany

Langenfeld

Hungary

Budapest

Italy

Lainate

Netherlands

Breda

Poland

Warsaw

Portugal

Baltar

Russia

Moscow

U.A.E.

Dubai

U.K.

Buckingham

China

Beijing

Chengdu

Guangzhou

Xian

Greater Asia-Pacific

Australia

Adelaide

Brisbane

Melbourne

Sydney

India

Calcutta

Chennai

Delhi

Hyderabad

Pune

Korea

Seoul

Philippines

Makati City

Singapore

Factories

Brazil

Alphaville

China

TaiAn

Zhangjiagang

France

Charlieu

Moulins

Germany

Wilhelmshaven

India

Pune

Italy

Niella Tanaro

Portugal

Baltar

Fânzeres

Slovakia

Saris

USA

Manitowoc

Port Washington

Shady Grove

This document is non-contractual. Constant improvement and engineering progress make it necessary that we reserve the right to make specification, equipment, and price changes without notice. Illustrations shown may include optional equipment and accessories and may not include all standard equipment.