

MODELS | ZB20044



Service Manual

ZOOM BOOM SERIES TELESCOPIC MATERIAL HANDLER

Part No. 402509AD October 2013

SKYJACK

This manual is based on Serial Numbers:

ZB 2044 85,800,072 & Below

Please refer to the website - www.skyjack.com for older Serial Numbers.

Skyjack Service Center

3451 Swenson Ave. St. Charles,
Illinois, 60174 USA
Phone: 630-262-0005
Toll Free: 1-800-275-9522
Fax: 630-262-0006
Email: service@skyjack.com

Parts (North America)

Toll Free: 1-800-965-4626
Toll Free Fax: 1-888-782-4825
E-mail: parts@skyjack.com

Skyjack Australia Pty Ltd.

4 Coates Place
Wetherill Park
New South Wales 2164
Australia
Tel: +61 (0) 28786 3200
Fax: +61(0) 28786 3222

Parts & Service (Europe)

Unit 1 Maes Y Clawdd
Maesbury Road Industrial Estate
Oswestry, Shropshire SY10 8NN UK
Phone: +44-1691-676-235
Fax: +44-1691-676-238
E-mail: info@skyjackeurope.co.uk

Skyjack Brasil

Alameda Júpiter, 710
Loteamento American Park Empresarial
Indaiatuba, SP, Brasil 13347-653
Tel: +55 19 3936 0132

SERVICE AND MAINTENANCE

Table of Contents

Section 1 - Scheduled Maintenance

[Table of Contents](#)

Section 2 - Maintenance Tables

[List of Tables](#)

Section 3 - Schematics

[List of Contents](#)

Section 4 - Troubleshooting

[Troubleshooting](#)

Section 5 - Procedures

[List of Procedures](#)

[List of Tables](#)

The Safety Alert Symbol identifies important safety messages on telehandlers, safety signs in manuals or elsewhere. When you see this symbol, be alert to the possibility of personal injury or death. Follow the instructions in the safety message.



This Safety Alert Symbol means attention!

Become alert! Your safety is involved.



DANGER

DANGER indicates an imminently hazardous situation which, if not avoided, will result in death or serious injury.



WARNING

WARNING indicates a potentially hazardous situation which, if not avoided, could result in death or serious injury.



CAUTION

CAUTION indicates a potentially hazardous situation which, if not avoided, may result in minor or moderate injury. It may also be used to alert against unsafe practices.

IMPORTANT

IMPORTANT indicates a procedure essential for safe operation and which, if not followed, may result in a malfunction or damage to the telehandler.

Section 1
SCHEDULED MAINTENANCE

Table of Contents

Operator’s Responsibility for Maintenance

Telehandler Definition 7

Purpose of Equipment..... 7

Use of Equipment 7

Manual 7

Operator 7

Service Policy and Warranty..... 7

Optional Accessories..... 7

Scope of this Manual 8

Operator Safety Reminders..... 8

Electrocution Hazard 9

Safety Precautions..... 10

Maintenance and Inspection Schedule..... 15

Owner’s Annual Inspection Record 15

Replacement Parts..... 15

Maintenance and Service Safety Tips 15

Hydraulic System & Component Maintenance and Repair..... 16

Maintenance Hints 16

Service and Maintenance

About this Section..... 17

Service Bulletins 17

Maintenance and Inspection 17

Maintenance Instructions..... 17

Tables

1.1 Maintenance and Inspection Checklist 18

Scheduled Maintenance Inspections

1.1 Scheduled Maintenance Inspections 19

1.2 Function Tests..... 28

SKYJACK is continuously improving and expanding product features on its equipment, therefore, specifications and dimensions are subject to change without notice.

Telehandler Definition

A material handler designed primarily as a fork truck with a pivoting telescopic boom which enables it to pick and place loads at distances as well as various lift heights.

Purpose of Equipment

The SKYJACK telehandlers are designed to lift, handle and transport agricultural or industrial products by means of specific attachments.

Use of Equipment

The telehandler is a highly maneuverable, mobile work station. Lifting, handling and driving must be on a flat, level, compacted surface. It can be driven over uneven terrain only when the boom is fully lowered.

Manual Operating

The operating manual is considered a fundamental part of the telehandler. It is a very important way to communicate necessary safety information to users and operators. A complete and legible copy of this manual must be kept in the provided weather-resistant storage compartment on the telehandler at all times.

Service & Maintenance

The purpose of this is to provide the customer with the servicing and maintenance procedures essential for the promotion of proper machine operation for its intended purpose.

All information in this manual should be read and understood before any attempt is made to service the telehandler. The updated copy of the manuals are found on the company's website: www.skyjack.com.

Operator

The operator must read and completely understand both this operating manual and the safety panel label located on the telehandler and all other warnings in this manual and on the telehandler. Compare the labels on the telehandler with the labels found within this manual. If any labels are damaged or missing, replace them immediately.

Service Policy and Warranty

SKYJACK warrants each new ZB series telehandler to be free of defective parts and workmanship for the first 12 months or 2000 hours, whichever occurs first. Any defective part will be replaced or repaired by your local SKYJACK dealer at no charge for parts or labor. Contact SKYJACK Service Department for warranty statement extensions or exclusions.

Optional Accessories

The SKYJACK telehandler is designed to accept a variety of optional accessories. These are listed under "Attachments Installation and Operation" in [Section 2](#) of the operating manual. Operating instructions for these options (if equipped) are located in [Section 2](#) of the operating manual.

For non-standard components or systems, contact the SKYJACK Service Department at

 : 800 275-9522

 : 630 262-0006

Include the model and serial number for each applicable telehandler.

Scope of this Manual

- a. **This manual applies** to the ANSI/ASME/ITSDF and CSA versions of the ZB20032 & ZB20044 telehandlers.
- **Equipment identified** with "ANSI" meets the ASME/ANSI B56.6 standard.
 - **Equipment identified** with "CSA" meets the CSA B335-04 standard.
- b. **CSA (Canada)**
Operators are required to conform to national, territorial/provincial and local health and safety regulations applicable to the operation of this telehandler.
- c. **ANSI (United States)**
Operators are required by the current ANSI standards to conform to national, territorial/provincial and local health and safety regulations applicable to the operation of this telehandler.

**warning**

Failure to comply with your required responsibilities in the use and operation of the telehandler could result in death or serious injury!

Operator Safety Reminders

A study conducted by St. Paul Travelers showed that most accidents are caused by the failure of the operator to follow simple and fundamental safety rules and precautions.

You, as a careful operator, are the best insurance against an accident. Therefore, proper usage of this telehandler is mandatory. The following pages of this manual should be read and understood completely before operating the telehandler.

Common sense dictates the use of protective clothing when working on or near machinery. Use appropriate safety devices to protect your eyes, ears, hands, feet and body.

Some attachments may not be approved for use with certain telehandler models. Use only approved attachments.

Any modifications from the original design are strictly forbidden without written permission from Skyjack.

Electrocution Hazard

This telehandler is NOT electrically insulated. Use extreme caution around high-voltage overhead power lines and maintain a Minimum Safe Approach Distance (MSAD) of 10 feet from source of power. Adhere to all federal/national, state/provincial, or local safety regulations for your own protection.

No part of telehandler or payload should be brought closer to any energized overhead electrical conductor with nominal phase voltage rating as specified below:

Voltage	Distance
750 to 150,000	10 feet
150,000 to 250,000	15 feet
250,000	20 feet

**DANGER**

Never approach any power line with any part of telehandler. Use extreme caution; serious injury or death can result with contact from any power line.

IMPORTANT

Always assume electrical power sources and overhead lines are energized.

**DO NOT USE TELEHANDLER AS A GROUND FOR WELDING.
DO NOT OPERATE TELEHANDLER DURING LIGHTNING OR STORMS.**

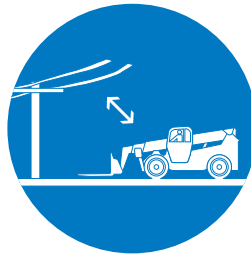

Safety Precautions

Know and understand all safety precautions before going on to the next section.

 **WARNING**

DO NOT operate this telehandler without proper authorization and training. Failure to avoid this hazard could result in death or serious injury.

 **WARNING**

Failure to heed the following safety precautions could result in tip over, falling, crushing, or other hazards leading to death or serious injury.

- **MAKE SURE** all DANGER, WARNING, CAUTION and INSTRUCTIONAL DECALS are in place and can be read. Clean or replace decals as required.
- **KNOW** all national, state/provincial and local rules which apply to your telehandler and jobsite.
- **WEAR** all the protective clothing and personal safety devices issued to you or called for by job conditions.

- **DO NOT** wear loose clothing, dangling neckties, scarves, rings, wristwatches or other jewelry while operating this telehandler.



- **DO NOT** climb on this vehicle for any reason.



- **DO NOT** stand on forks. Failure to heed could result in death or serious injury.



- **DO NOT** use telehandler as a man lift or equip this telehandler with a personnel work platform.



- **DO NOT** use carriage or any other portion of the boom for slinging loads



- **DO NOT** elevate the boom in windy or gusty conditions.



- **DO NOT** drive with boom elevated.



- **DO NOT** operate on surfaces not capable of holding the weight of the telehandler; including the rated load (e.g., covers, drains, and trenches).



- **DO NOT** maneuver a load while moving. This greatly increases the chance of spills and injury.



Safety Precautions (Continued)

Know and understand all safety precautions before going on to the next section.

- **DO NOT** exceed the maximum safe operating slope.

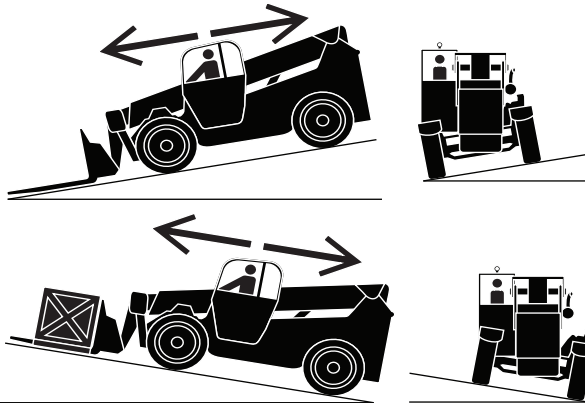

- **DO NOT** lower the boom unless the area below is clear of personnel and obstruction.



- **DO NOT** elevate the boom while the telehandler is on a truck, forklift or other device or vehicle.



- **DO NOT** use frame leveling when boom is elevated. It is recommended that frame leveling be used only when boom is retracted and in the lowered position.



- **ENSURE** that there are no personnel or obstructions in the path of travel, including blind spots.



- **BE AWARE** of blind spots when operating the telehandler.

- **DO NOT** use the frame leveling mechanism to compensate for swinging loads.

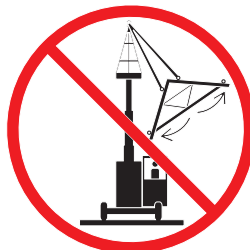

- **ALWAYS** Keep head, arms, hands, legs and all other body parts inside the operator's cab.



- **DO NOT** enter the danger area under or around the boom when forks are off the ground or while engine is running.



- **AVOID** jerks and sudden stops.



- **AVOID** entanglement with ropes, cords or hoses.



Safety Precautions (Continued)

Know and understand all safety precautions before going on to the next section.

- **BE AWARE** of all obstructions while traveling. Check for clearance before traveling between obstacles.

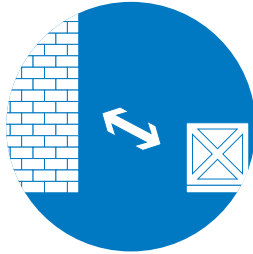

- **USE CAUTION** when boom is fully extended. The further out the boom is extended, the less load telehandler can support.



- **USE CAUTION** when placing loads at high elevations and on downhill slopes.



- **WALK AROUND** the telehandler before operation and check for any visible signs of damage or malfunction.

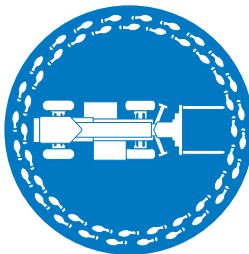

- **ALWAYS** maintain three points of contact when entering vehicle. Use provided hand-holds and steps only.



- **ALWAYS** wear your seat belt when operating this vehicle.



- **KNOW** the weight of the load you are transporting. Never lift more than the lifting capacity at any given extension or elevation of the boom as listed on the capacity charts.



- **CHECK** for cracks and signs of stress.



- **TRAVEL SLOWLY** over rough terrain.



- **If operation in areas with holes or dropoffs is absolutely necessary**, ensure that all 4 wheels or outriggers (if equipped) have contact with firm surface. Then level the frame. Once frame is level the boom can be elevated. After elevation, the drive function must not be activated.



- **DRIVE DOWNHILL UNLOADED.** Without a load, the back end is the heaviest part of the telehandler. Driving downhill decreases potential for tipover.

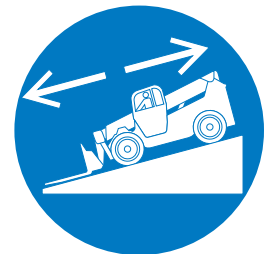

Safety Precautions (Continued)

Know and understand all safety precautions before going on to the next section.

- **DRIVE UPHILL LOAD-ED.** When holding a load, driving uphill decreases potential for load to slip out.

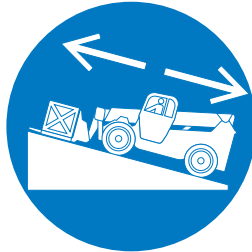

- **TETHER LOADS** that may swing, keeping them close to the ground. Provide ample clearance for personnel to guide the load safely.



- **ALWAYS LEVEL FRAME** before elevating the boom

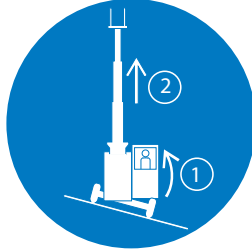

- **SLINGING LOADS** is acceptable only when the load is appropriately attached to a jib boom or the throat of a tilted fork, and the precautions outlined in Section 1.1 are followed.



- **WHEN TRANSPORTING LOADS** fully retract the boom, keep the load low to the ground and forks tilted back slightly. This is the most stable position possible for the vehicle.



- **BE AWARE** of the telehandler's travel envelope, especially when turning. Keep sufficient clearance at all times between the telehandler and any obstacles or people.

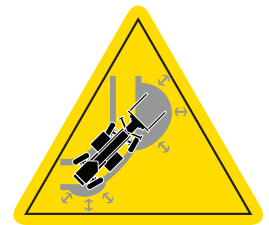

- **KEEP** forks close to the ground when in motion to increase telehandler stability and decrease potential for injury to others. When fully stopped, lower forks completely to the ground.

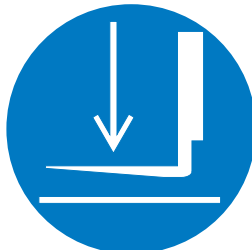

- **KEEP OTHERS AWAY** at all times during operation.

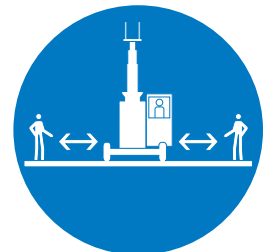

- **TILT** forks backwards slightly when traveling to decrease potential of load slipping off.

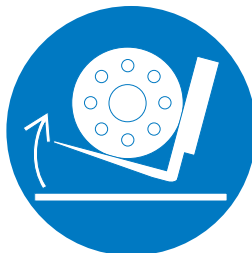

- **CHECK** lights (if equipped) for proper function before operating.



- **SECURE** loose loads with chains or straps to decrease potential of spills or injury to others.

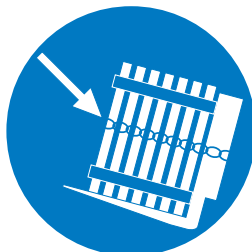

- **ENSURE ALL** tires are in good condition and lug nuts are properly tightened.

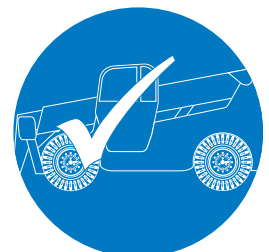

Safety Precautions (Continued)

Know and understand the safety precautions before going on to next section.

- **DO NOT** alter or disable safety devices.
- **DO NOT** burn or drill holes in forks. Modifying any part of telehandler or attachment affects its capacity and/or stability.
- **DO NOT** try to start the telehandler by pushing or towing. Such operation may cause severe damage to the transmission - Refer to [Section 2 of the Operating Manual](#).
- **IF DRIVING ON ROADS OPEN TO PUBLIC TRAFFIC** respect the local regulations.
- **THE OPERATOR'S CAB** provides a falling object protection structure (FOPS) and a rollover protection structure (ROPS). **Do not make any modification to this structure.** If damaged, the cab cannot be repaired. It must be replaced.
- **STUNT** driving and horseplay are prohibited.
- **ALWAYS USE FRONT** steering when traveling at high speeds; i.e. on highways or public roads.
- **DO NOT** change steering mode while the telehandler is traveling. Change the steering mode only when telehandler is stopped, and wheels aligned straight ahead.
- **ALWAYS** look in the direction of travel. Reduce speed and be careful especially when traveling in reverse and/or turning. Bring the telehandler to a complete stop before changing the direction of travel.
- **STAY CLEAR** of pinch points and rotating parts on the material handler. Getting caught in a pinch point or a moving part can cause serious injury or death. Before performing any maintenance on telehandler, follow the shutdown procedure in [Section 2.9-9 of the Operating Manual](#).
- **DO NOT** position the telehandler against another object to steady the load.
- **SHUT DOWN** by positioning the telehandler in a safe location. Lower forks to ground, apply the parking brake, move all controls to 'neutral' and allow engine to run at low idle for 3 to 5 minutes after a full load operation. Stop engine and remove ignition key to prevent unauthorized use. Block tires.



WARNING

Always engage park brake and shut off engine before leaving the operator's cab.

Safety Precautions (Continued)

Know and understand the safety precautions before going on to next section.



WARNING

Operator should not use any telehandler that:

- does not appear to be working properly.
- has been damaged or appears to have worn or missing parts.
- has alterations or modifications not approved by the manufacturer.
- has safety devices which have been altered or disabled.
- has been tagged or locked out for non-use or repair.
- bears an unapproved attachment.

Failure to avoid these hazards could result in death or serious injury.

Maintenance and Inspection Schedule

The actual operating environment of the telehandler governs the use of the maintenance schedule. The inspection points covered in [Table 1.1](#). Maintenance and Inspection Checklist, indicates the areas of the telehandler to be maintained or inspected and at what intervals the maintenance and inspections are to be performed.

Owner's Annual Inspection Record

It is the responsibility of the owner to arrange quarterly and annual inspections of the telehandler. Owner's Annual Inspection Record is to be used for recording the date of the inspection, owner's name, and the person responsible for the inspection of the telehandler.

Replacement Parts

Use only original replacement parts. Parts such as wheels, etc. with weight and dimensions different from original parts will affect stability of the telehandler and must not be used without manufacturer's consent.

All replacement tires must be of the same size and load rating as originally supplied tires; to maintain safety and stability of telehandler.

Replacement attachments must be equivalent to the originals and be associated with manufacturer approved capacity charts.

Consult SKYJACK's Service Department for optional tires specifications and installation.



WARNING

Any unit that is damaged or not operating properly must be tagged and removed immediately from service until proper repairs are completed.

Maintenance and Service Safety Tips

Maintenance and repair should only be performed by personnel who are trained and qualified to service this telehandler.

All maintenance and service procedures should be performed in a well lighted and well ventilated area.

Anyone operating or servicing this telehandler must read and completely understand all operating instructions and safety hazards in this manual and operating manual.

All tools, supports and lifting equipment to be used must be of proper rated load and in good working order before any service work begins. Work area should be kept clean and free of debris to avoid contaminating components while servicing.

All service personnel must be familiar with employer and governmental regulations that apply to servicing this type of equipment.

Keep sparks and flames away from all flammable or combustible materials.

Properly dispose of all waste material such as lubricants, rags, and old parts according to the relative law provisions obtaining in the country.

Preventive maintenance is the easiest and least expensive type of maintenance.

Jobsite Inspection

- Do not use in hazardous locations.
- Perform a thorough jobsite inspection prior to operating the telehandler, to identify potential hazards in your work area.
- Be aware of moving equipment in the area. Take appropriate actions to avoid possible collision.

Hydraulic System & Component Maintenance and Repair

The following points should be kept in mind when working on the hydraulic system or any component:

**WARNING**

Escaping fluid from a hydraulic pressure leak can damage your eyes, penetrate the skin and cause serious injury. Use proper personal protection at all times.

1. Any structure has limits of strength and durability. To prevent failure of structural parts of hydraulic components, relief valves which limit pressure to safe operating values are included in the hydraulic circuits.
2. Tolerance of working parts in the hydraulic system is very close. Even small amounts of dirt or foreign materials in the system can cause wear or damage to components, as well as general faulty operation of the hydraulic system. Every precaution must be taken to assure absolute cleanliness of the hydraulic oil.
3. Whenever there is a hydraulic system failure which gives reason to believe that there are metal particles or foreign materials in the system, drain and flush the entire system and replace the filter cartridges. A complete change of oil must be performed under these circumstances.
4. All containers and funnels used in handling hydraulic oil must be absolutely clean. Use a funnel when necessary for filling the hydraulic oil reservoir, and fill the reservoir only through the filter opening. The use of cloth to strain the oil should be avoided to prevent lint from getting into the system.
5. When removing any hydraulic component, be sure to cap and tag all hydraulic lines involved. Also, plug the ports of the removed components.
6. All hydraulic components must be disassembled in spotlessly clean surroundings. During disassembly, pay particular attention to the identification of parts to assure proper reassembly. Clean all metal parts in a clean mineral oil solvent. Be sure to thoroughly clean all internal passages. After the parts have been dried thoroughly, lay them on a clean, lint-free surface for inspection.
7. Replace all O-rings and seals when overhauling any component. Lubricate all parts with clean hydraulic oil before reassembly. Use small amounts of petroleum jelly to hold O-rings in place during assembly.
8. Be sure to replace any lost hydraulic oil when completing the installation of the repaired component, and bleed any air from the system when required.
9. All hydraulic connections must be kept tight. A loose connection in a pressure line will permit the oil to leak out or air to be drawn into the system. Air in the system can cause damage to the components and noisy or erratic system operation.

Maintenance Hints

Three simple maintenance procedures have the greatest effect on the hydraulic system performance, efficiency and life. Yet, the very simplicity of them may be the reason they are so often overlooked. What are they? Simply these:

1. Change filters annually. The filters will need to be changed more often depending on the operating conditions. Dirty, dusty, high moisture environments may cause the hydraulic system to be contaminated more quickly.
2. Maintain a sufficient quantity of clean hydraulic oil of the proper type and viscosity in the hydraulic reservoir.
3. Keep all connections tight.

About this Section

This section contains the maintenance and inspection schedule that is to be performed.

References are made to the procedures in Section 5 that outline detailed step-by-step instructions for checks and replacements.

Service Bulletins

Before performing any scheduled maintenance inspection procedure, refer to service bulletins found in our web site: www.skyjack.com for updates related to service and maintenance of this telehandler.

Maintenance and Inspection

Death or injury can result if the telehandler is not kept in good working order. Inspection and maintenance should be performed by competent personnel who are trained and qualified on maintenance of this telehandler.

**WARNING**

Failure to perform each procedure as presented and scheduled may cause death, serious injury or substantial damage.

NOTE

Preventive maintenance is the easiest and least expensive type of maintenance.

- Unless otherwise specified, perform each maintenance procedure with the telehandler in the following configuration:
 - Telehandler parked on a flat and level surface
 - Engine is turned off.
- Repair any damaged or malfunction components before operating telehandler.
- Keep records on all inspections.

Maintenance Instructions

This manual consists of four schedules to be done for maintaining on a telehandler. Inspection schedule frequency is shown below:

Inspection Schedule

Daily	A
Weekly or 40 hours	A + B
Quarterly or 250 hours	A + B + C
Annually or 1000 hours	A + B + C + D

- Make copies of the maintenance and inspection checklist to be used for each inspection.
- Check the schedule on the checklist for the type of inspection to be performed.
- Place a check in the appropriate box after each inspection procedure is completed.
- Use the maintenance and inspection checklist and step-by-step procedures in [Section 5](#) to perform these inspections.
- If any inspection receives a fail, tag and remove the telehandler from service.
- If any telehandler component(s) has been repaired, an inspection must be performed again before removing the tag. Place a check in the repair column.

Legend

P = Pass
F = Fail
R = Repaired



Table 1.1 MAINTENANCE AND INSPECTION CHECKLIST

Serial Number: _____
 Model: _____
 Hourmeter Reading: _____ Operator's Name (Printed): _____
 Date: _____
 Time: _____ Operator's Signature: _____

Each item shall be inspected using the appropriate section of the Skyjack operating manual.
 As each item is inspected, write the appropriate grade in the box.

P - PASS F - FAIL R - REPAIRED	INSPECTION FREQUENCY			Inspection Schedule	
	<input type="checkbox"/> DAILY			Daily	A
	<input type="checkbox"/> WEEKLY or 40 HOURS			Weekly or 40 Hours	A + B
	<input type="checkbox"/> QUARTERLY OR 250 HOURS			Quarterly or 250 Hours	A + B + C
	<input type="checkbox"/> ANNUALLY or 1000 HOURS			Annually or 1000 Hours	A + B + C + D

Schedule	P	F	R
Schedule Maintenance Inspections			
Labels	A		
Electrical	A		
Safety Switches	A		
Mirrors	A		
Hydraulic	A		
Cylinders	A,B,C,D		
Frame			
Wheel/Tire Assembly	A		
Batteries and Cables	A		
Engine Air Filter	A,B,C		
Engine Coolant	A		
Muffler and Exhaust	A		
Drive Axles			
Hub Oil	C		
Change Differential Oil	D		
Pinion Seal	A		
Inner and Outer Shaft Seals	A		
Hub Seals	A		
King Pins	C,D		
Check Drive Shafts and U-Joints	C,D		
Axle Mounting Pins and Bushings	C,D		
Axle Housing	A		
Steer Cylinder Assembly	A		
Steer Linkage	A		
Engine Compartment			
Engine Oil	A,C		
Fuel Leaks	A		
Hydraulic Pump	A		
Belts and Hoses	A		
Fuel Tank	A		
Change Fuel Filter	A,C		
Drain Water from Fuel Filter	C,D		
Hydraulic Tank	A		
Hydraulic Oil	A,D		
Hydraulic Return Filter	A,C		
Change Oil Filters	A,C		
Charging System	A		
Transmission			
Operate and Check Shifting	A		
Check for Leaks	A		
Check Transmission Disconnect	A		

Schedule	P	F	R
Change Transmission Filter			
	D		
Boom			
Main pins and bushings	C,D		
subcarriage pins and bushings	C,D		
Rollers and Tracks	C,D		
Slide Pads	B,C,D		
Chain	A,C		
Boom Angle Indicator	A		
Proximity Sensor	A		
Lifting Attachment	A		
Forks	A		
Fork Bars and Locks	A		
Grease Fittings			
Grease Fittings on Frame	B		
Grease Fittings on Boom Assembly	B		
Operator's Cab			
ROPS/FOPS	A		
Seat	A		
Pedals	A		
Manual	A		
Operator's Cab Controls	A		
Function Tests			
Operator's Cab Controls			
Test Starter Operation	A		
Test Horn	A		
Test Reverse Alarm	A		
Test Gauges	A		
Test Lights	A		
Test Switches	A		
Test Steering Wheel and Column	A		
Test Boom and Attachment Functions	A		
Test Frame Leveling and Level Indicator	A		
Test Frame Level Lock	A		
Test Accelerator Pedal	A		
Test Driving and Service Brake Functions	A		
Test Steering	A		
Test Parking Brake	A		
Test Outriggers (if equipped)	A		
Test Outrigger Control & Boom Extension Interlock System	A		

202A

- A - Perform Visual and Daily Maintenance Inspections & Functions Test. Refer to Section 2.7 of the Operating Manual.
- B - Perform Scheduled Maintenance Inspection every week or 40 hrs. Refer to Section 1.0 of this manual.
- C - Perform Scheduled Maintenance Inspection every 3 months or 250 hours. Refer to Section 1.0 of this manual.
- D - Perform Scheduled Maintenance Inspection every year or 1000 hours. Refer to Section 1.0 of this manual.

Note: Make a copy of this page or visit the Skyjack web site: www.skyjack.com for a printable copy.



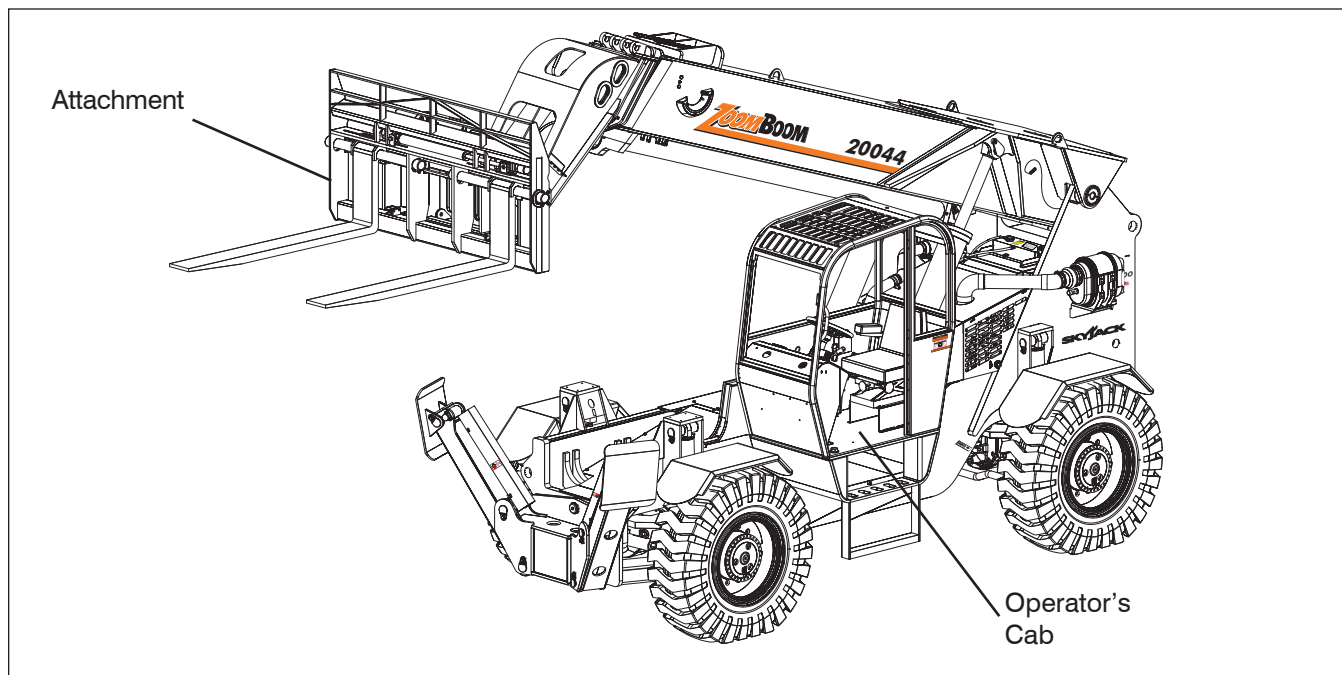

1.1 Scheduled Maintenance Inspections

Before performing the visual and daily maintenance inspections, ensure that the telehandler is parked on a firm level surface.

Begin the visual and daily maintenance inspections by checking each item in sequence for the conditions listed in this section.



WARNING

To avoid injury, do not operate a telehandler until all malfunctions have been corrected.



WARNING

To avoid possible injury, ensure telehandler power is off during your visual and daily maintenance inspections.

NOTE

While performing visual and daily inspections in different areas, be aware to also inspect all switches, electrical and hydraulic components.

1.1-1 Labels

Refer to the labels section in the parts manual and determine that all labels are in place and are legible.

1.1-2 Electrical

Maintaining the electrical components is essential to good performance and service life of the telehandler.

- Ensure proper operation of all gauges
- Check charging system Ammeter/Voltmeter
- Inspect the following areas for chafed, corroded and loose wires:
 - boom wiring harnesses
 - frame wiring harnesses
 - cab wiring harnesses

Ensure electrical devices are properly secured with no signs of visible damage. Ensure there are no loose or missing parts.

1.1-3 Safety Switches

Ensure safety switches are properly secured with no signs of visible damage.

1.1-4 Mirrors

Ensure mirrors are properly secured with no signs of visible damage.

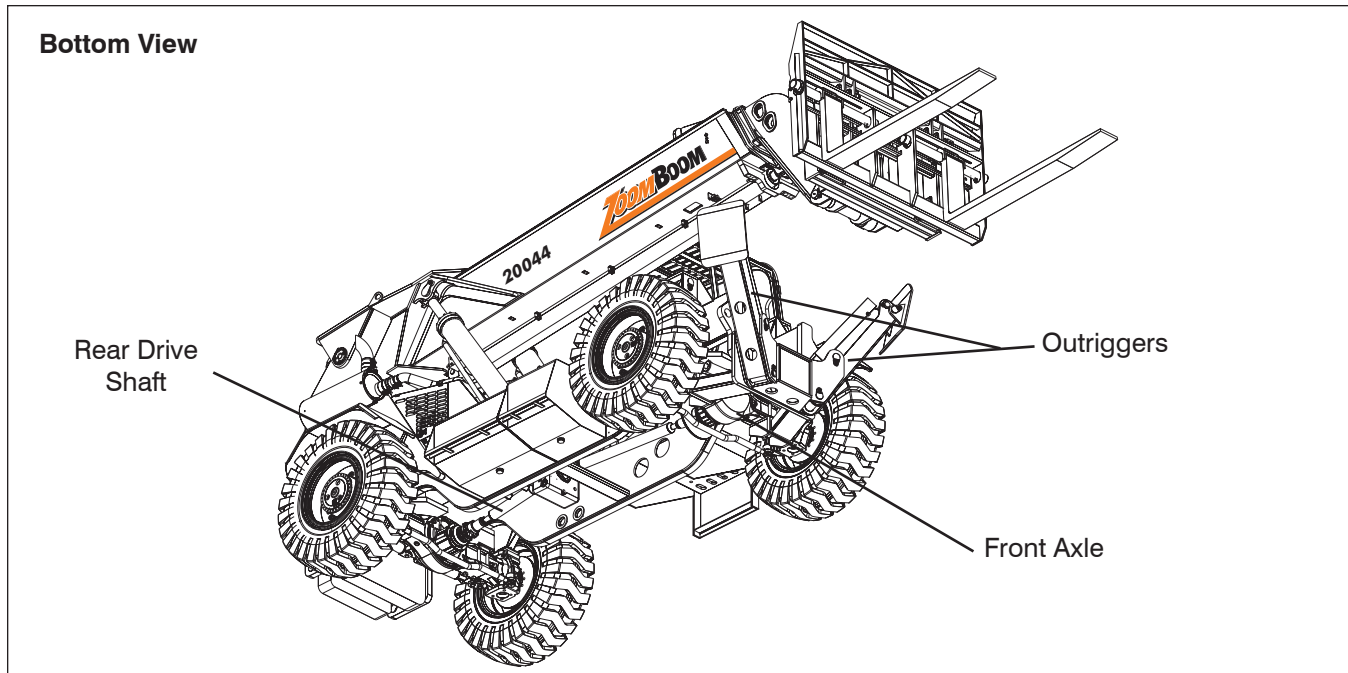

1.1-5 Hydraulic

Maintaining the hydraulic components is essential to good performance and service life of the telehandler. Perform a visual inspection and check for leaks around the following areas:

- hydraulic tank, filter(s), fittings, hoses, pump, and frame surface
- all hydraulic cylinders
- all hydraulic manifolds
- underside of the frame
- ground area under the telehandler

- Check all tire treads and sidewalls for cuts, cracks, punctures and unusual wear.
- Check each wheel for damage and cracked welds.
- Check each lug nut for proper torque to ensure none are loose.

To safeguard maximum stability, achieve optimum telehandler handling and minimize tire wear, it is essential to maintain proper pressure in all air-filled tires.

1.1-6 Cylinders

- Ensure all cylinders are properly secured and there is no evidence of leakage.
- Grease weekly and check pins and bushings to ensure there is no evidence of damage.

- Check each tire with an air pressure gauge and add air as needed.
- **Drive Axle**
 - Ensure drive axle is properly secured, there are no loose or missing parts.

1.1-7 Frame

• **Wheel/Tire Assembly**

The telehandler is either equipped with air tires or foam-filled tires. Tire and/or wheel failure could result in a telehandler tipover. Component damage may also result if problems are not discovered and repaired in a timely fashion.

D - Annual Inspection

- For differential oil replacement procedure, refer to Section 5.
- **Steer Cylinder Assembly**
 - Ensure steer cylinder assembly is properly secured, there are no loose or missing parts, all fittings and hoses are properly tightened and there is no evidence of hydraulic oil leakage.
- **Steer Linkage**
 - Ensure there are no loose or missing parts, steer linkage studs are locked and there is no visible damage.



WARNING

An over-inflated tire can explode and may cause death or serious injury.

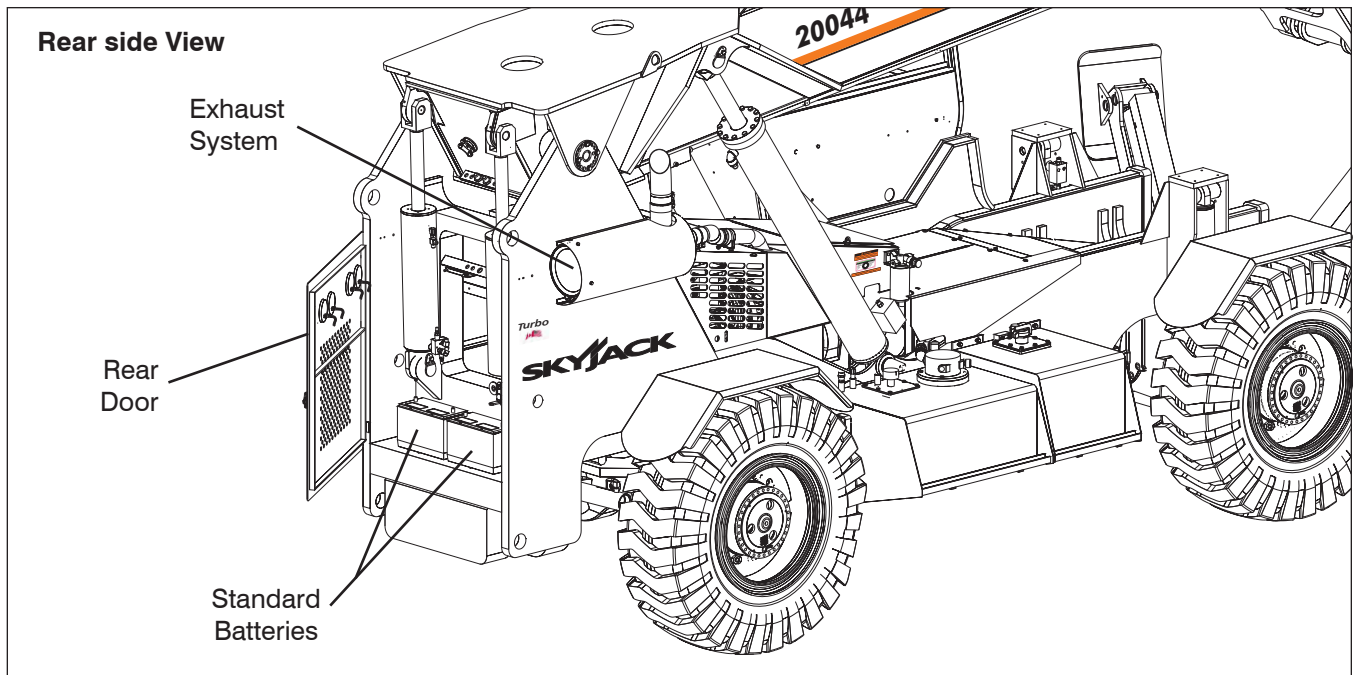

- **Batteries**

Proper battery condition is essential to good engine performance and operational safety. Improper fluid levels or damaged cables and connections can result in engine component damage and hazardous conditions.



WARNING

Explosion hazard. Keep flames and sparks away. Do not smoke near batteries.



WARNING

Battery acid is extremely corrosive - Wear proper eye and facial protection as well as appropriate protective clothing. If contact occurs, immediately flush with cold water and seek medical attention.

1. Check batteries case for damage.
2. Clean terminals and cable ends thoroughly with a terminal cleaning tool or wire brush.
3. Ensure all connections are tight.
4. If applicable, check battery fluid level. If plates are not covered by at least 1/2" (13 mm) of solution, add distilled or demineralized water.

5. Replace batteries if damaged or incapable of holding a lasting charge.



WARNING

Use original or manufacturer-approved parts and components for the telehandler.

- **Engine Air Filter**

- Ensure there are no loose or missing parts and there is no visible damage.
- Ensure air cleaner vacuumator valve (if applicable) is free from dirt or dust by squeezing the valve lips.

- **B - Weekly Inspection**

- For engine air filter inspection procedure, refer to [Section 5](#).

- **C - Quarterly Inspection**

- For engine air filter replacement procedure, refer to [Section 5](#).

- **Engine Coolant**

- The coolant level should be between the minimum and maximum marks. Add coolant as needed. Refer to your engine manual for recommended coolant mixture.

- **Muffler and Exhaust**

- Ensure muffler and exhaust systems are properly secured, with no evidence of damage.

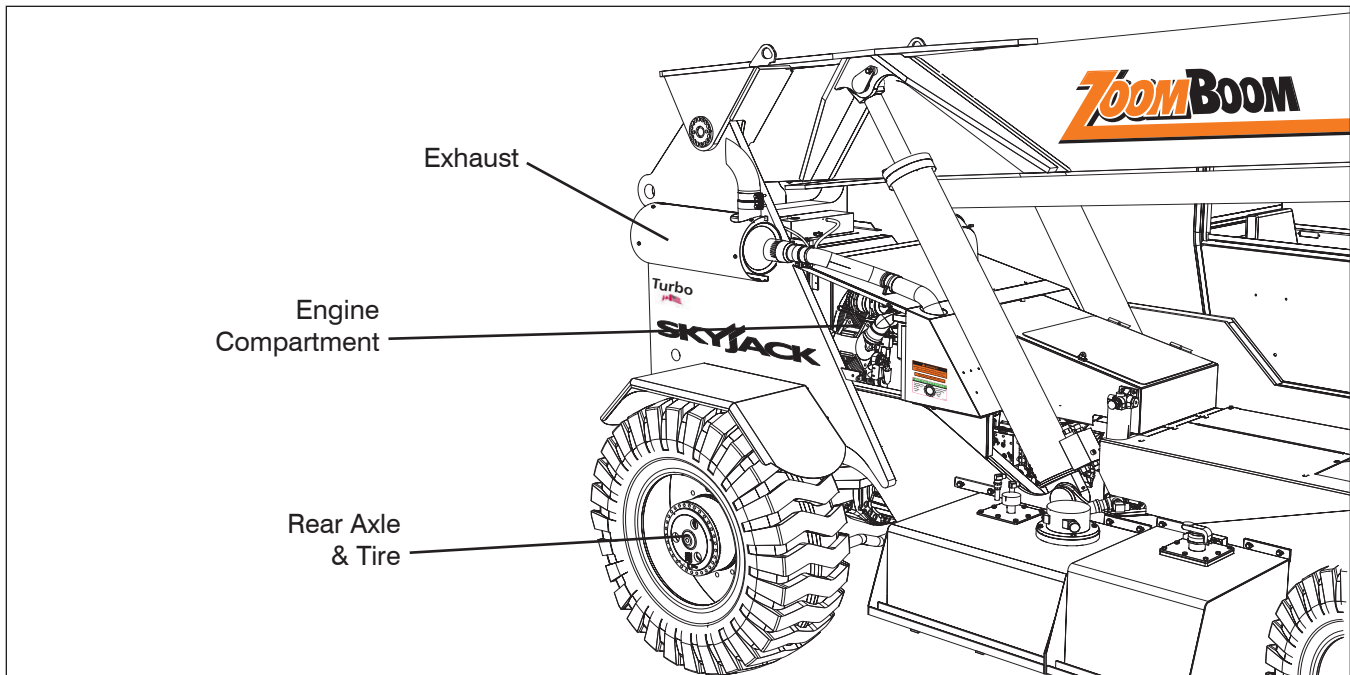

1.1-8 Engine Compartment

- Ensure compartment cover is secure and in proper working order.
- **Engine Oil Level**
 - Maintaining the engine components is essential to good performance and service life of the telehandler.



WARNING

Beware of hot engine components.

Check oil level on dipstick

- Oil level should be in the “safe” zone. Add oil as needed. Refer to [Table 2.2](#) for recommended oil type.

C - Quarterly Inspection

- For engine oil replacement procedure, refer to [Section 5](#)

- **Fuel Leaks**

Failure to detect and correct fuel leaks will result in an unsafe condition. An explosion or fuel fire may cause death or serious injury.



DANGER

Engine fuels are combustible. Inspect the telehandler in an open, well-ventilated area away from heaters, sparks and flames. Always have an approved fire extinguisher within easy reach.

Perform a visual inspection around the following areas:

- hoses and fittings
- fuel pump
- fuel filter
- fuel tank
- **Fuel Filter**
 - Ensure there are no loose or missing parts and there is no visible damage or evidence of leakage.
- C - Quarterly Inspection**
 - For fuel filter replacement procedure, refer to [Section 5](#)
- **Hydraulic Pumps**
 - Ensure there are no loose or missing parts and there is no visible damage.
 - Ensure all bolts are properly tightened.
 - Ensure all fittings and hoses are properly tightened and there is no evidence of hydraulic oil leakage.
- **Belts**
 - Ensure belts are in good working condition and have correct tension. Replace if belts are cracked, frayed, or have chunks of material missing. Refer to service manual for proper replacement procedure.

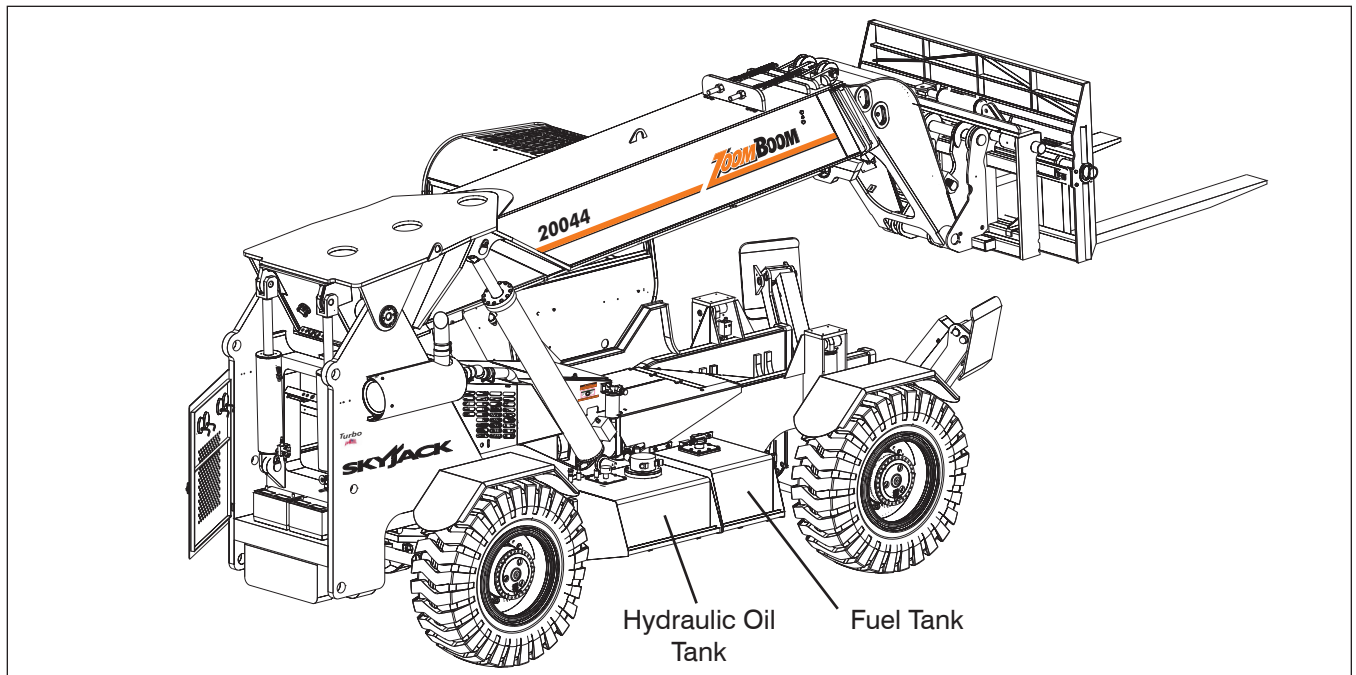

- **Fuel Tank**

IMPORTANT

Before using your telehandler ensure there is enough fuel for expected use.

- Ensure fuel filler cap is secure.
- Ensure tank shows no visible damage and no evidence of fuel leakage.

- **Hydraulic Tank**

- Ensure hydraulic filler cap is secure.
- Ensure tank shows no visible damage and no evidence of hydraulic leakage.

- **Hydraulic Oil**

- Be sure that the boom is in the stowed position, and then visually inspect the sight gauge located on the side of the hydraulic oil tank.
- The hydraulic oil level should be between the minimum and maximum marks on the sight glass. Add oil as needed. Refer to [Table 2.2](#) for recommended oil type.

D - Annual Inspection

- For hydraulic oil and filter replacement procedures, refer to [Section 5](#).

- **Hydraulic Return Filter**

- Ensure filter element is secure.
- Ensure there are no signs of leakage or visible damage.

1.1-9 Transmission

- Ensure transmission shifter is working properly and there is no evidence of damage.

- **Check oil level on dipstick**

- Oil level should be in the “safe” zone. Add oil as needed. Refer to [Table 2.2](#) for recommended oil type.

D - Annual Inspection

- For hydraulic oil and filter replacement procedures, refer to [Section 5](#).

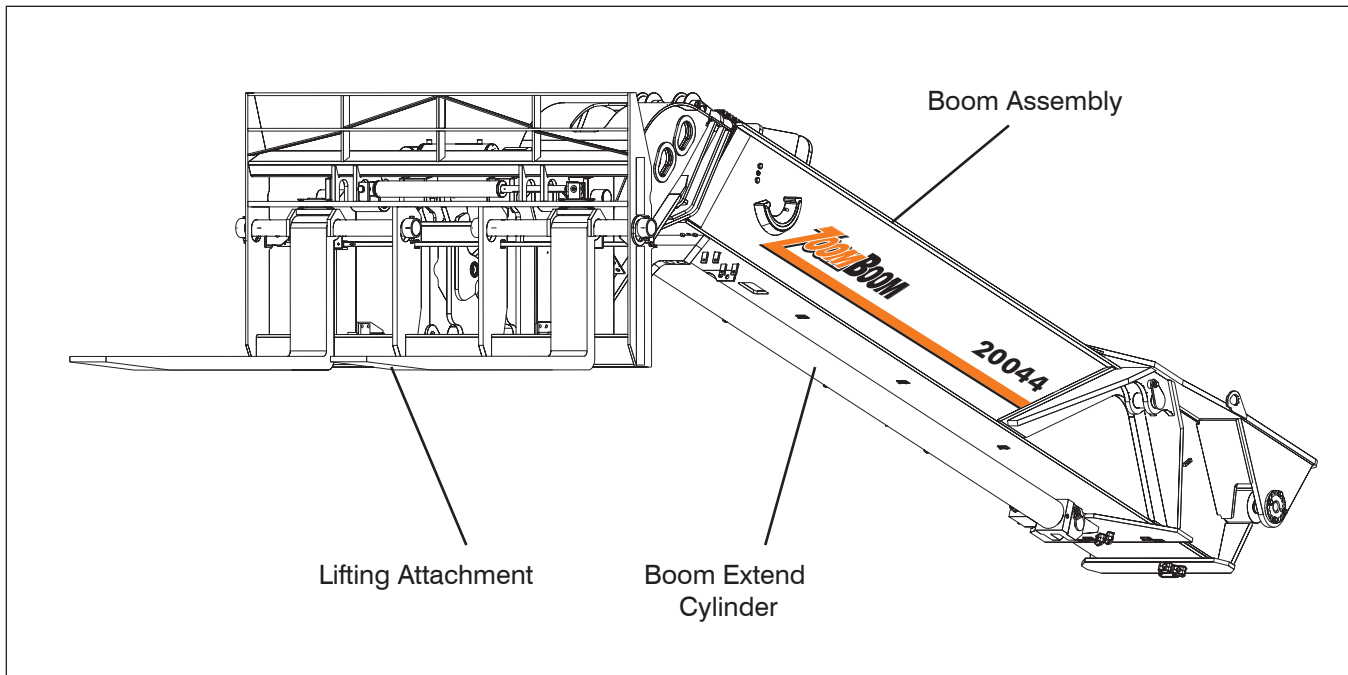
**1.1-10 Boom**

- Ensure there are no loose or missing parts and there is no visible damage.
- Ensure all bolts and pins are properly tightened.
- Ensure there are no visible cracks in welds or structure and there are no signs of deformation.
- Ensure all hoses are properly tightened and there is no evidence of hydraulic leakage.

- **Slide Pads**

- Ensure all bolts are tight, there is no visible damage to the slide pads and that no parts are missing.

- **Chain**

- Ensure there are no loose or missing parts and there is no visible damage

- **C - Quarterly Inspection**

- Check chain tension and adjust as required (refer to [Section 5](#)).

- **Boom Angle Indicator**

- Ensure all bolts are tight, and there is no visible damage

1.1-11 Lifting Attachment

- Ensure there are no loose or missing parts and there is no visible damage.
- Ensure attachment is properly positioned and secured. (refer to [Section 2.14](#) of the operating manual for attachments)

1.1-12 Grease Points

Maintaining properly greased components is essential for good performance and service life of the telehandler. If components are improperly greased, it could result in component damage.

**WARNING**

Ensure that there are no personnel or obstructions in maintenance area.

Greasing intervals are based on telehandler usage of 40 hours. Use of telehandler may vary significantly and greasing frequency must be adjusted to obtain maximum service life.

B - Weekly Inspection

- For greasing procedure, refer to [Section 5](#).

Axle Grease Points

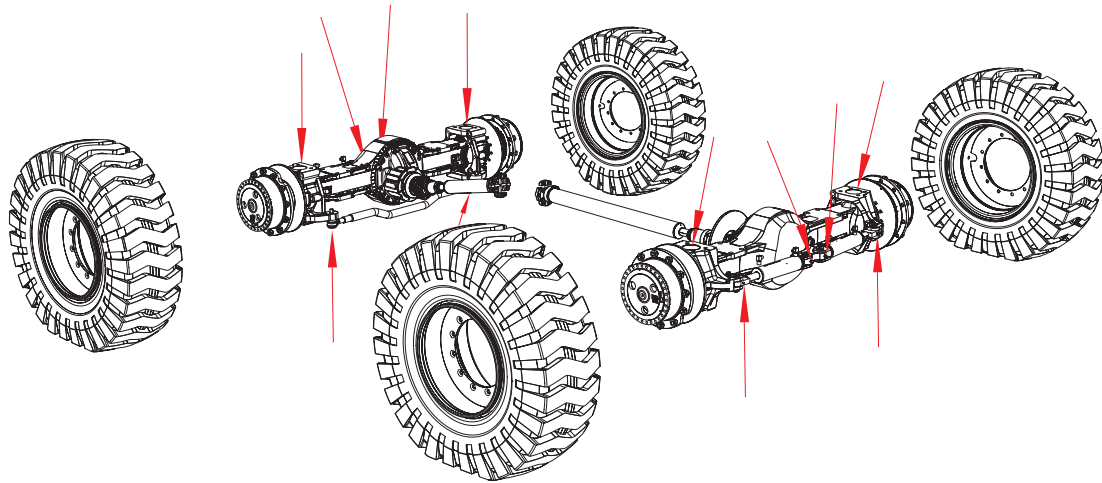

Grease Points on Frame

1. Ensure telehandler is on a firm level surface and is in stowed position.
2. Locate grease fittings (refer to label inside operator's cab) and pump grease in the following:
 - king pins
 - axle lock cylinder (top and bottom)
 - lift cylinder (top and bottom, both sides)
 - frame level cylinders (top and bottom)
 - outrigger pins
 - slave cylinders (top and bottom)
3. Using a creeper, slide under the frame to locate grease fittings and pump grease in the following:
 - axle pivot bearings (front and rear)
 - drive shaft U-joint (front and rear)
 - slip joint on drive shaft (front and rear)

Grease Points on Boom Assembly

1. Ensure telehandler is on a firm level surface and is in stowed position.
2. Locate grease fittings (refer to label inside operator's cab) and pump grease in the following:
 - main boom pivot bearing pins
 - retract chain rollers
 - hose rollers
 - extension chains and rollers
 - slide pads
 - attachment tilt cylinders (top and bottom)
 - attachment pivot bearings

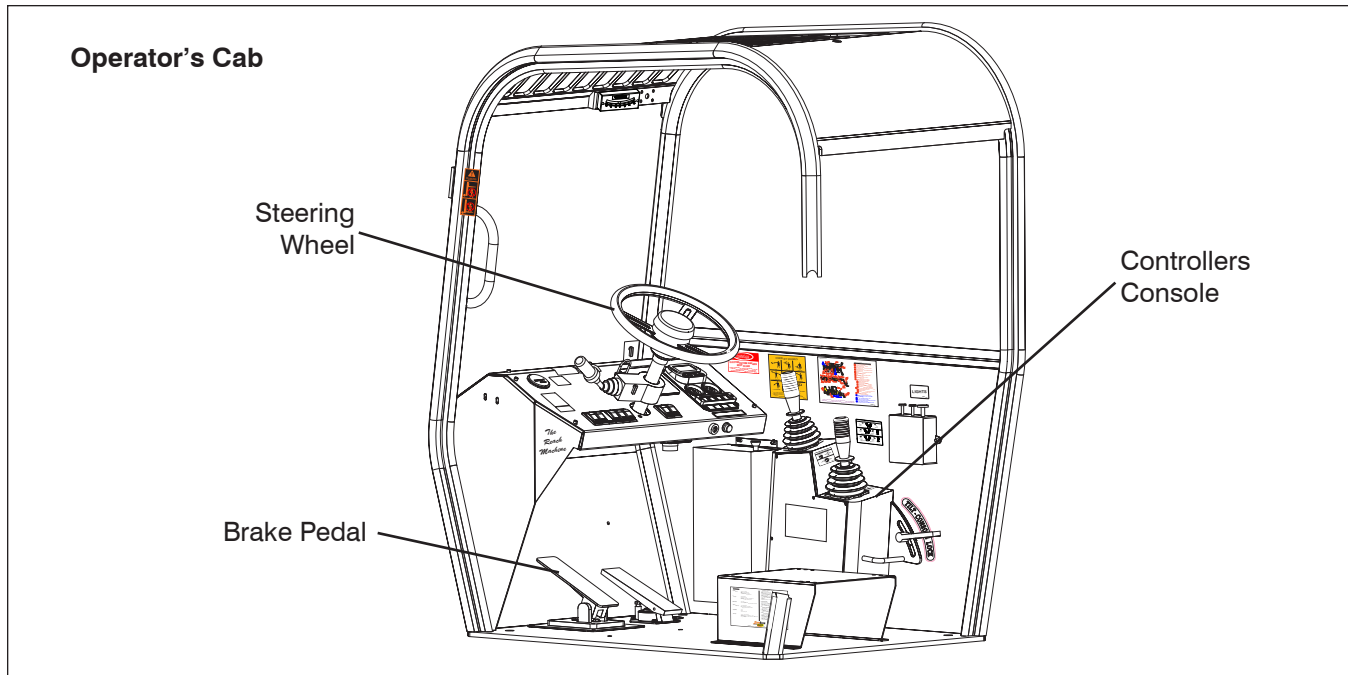

1.1-13 Operator's Cab

- **Rollover and Falling Object Protective Structure (ROPS/FOPS)**
 - Ensure there is no visible damage.



WARNING

Do not modify, drill or alter the operator's cab in any way.

- **Seat**
 - Ensure seat is properly secured with no sign of visible damage.
 - Ensure seat belt is working properly with no sign of visible damage.
- **Pedals**
 - Ensure brake and accelerator pedals are secure, no loose or missing parts, no sign of visible damage and movements are not obstructed.
- **Manual**
 - Check to be sure manual storage box is present and in good condition.
 - Ensure a copy of operating manual, and other important documentation are enclosed in manual storage box.
 - Ensure manual is legible and in good condition.

- Always return manual to the manual storage box after use.

- **Operator's Cab Controls**



WARNING

Ensure that you maintain three points of contact to mount/dismount the cab.

Use the steps of telehandler to access operator's cab.

- Ensure door and windows (if equipped) are secure and in proper working order.
- Ensure steering wheel is secured with no sign of visible damage.
- Ensure all switches and controls are properly secured with no sign of visible damage.
- Ensure all switches and controls are returned to their neutral positions and movements are not obstructed.
- Ensure capacity charts are in place and are legible.



DANGER

Do not operate the telehandler if capacity charts are missing or not legible.

1.1-14 Slinging Loads**CAUTION**

Sling loads from appropriate attachment to the jib boom or a tilted fork ONLY.

1. Slinging of loads must only be performed following a complete risk assessment by a qualified person regarding the rigging and guiding of any such load.
2. The rated capacity of the unit and attachment at the sling position must not be exceeded. The sling must be in good repair and restrained from movement at all times.

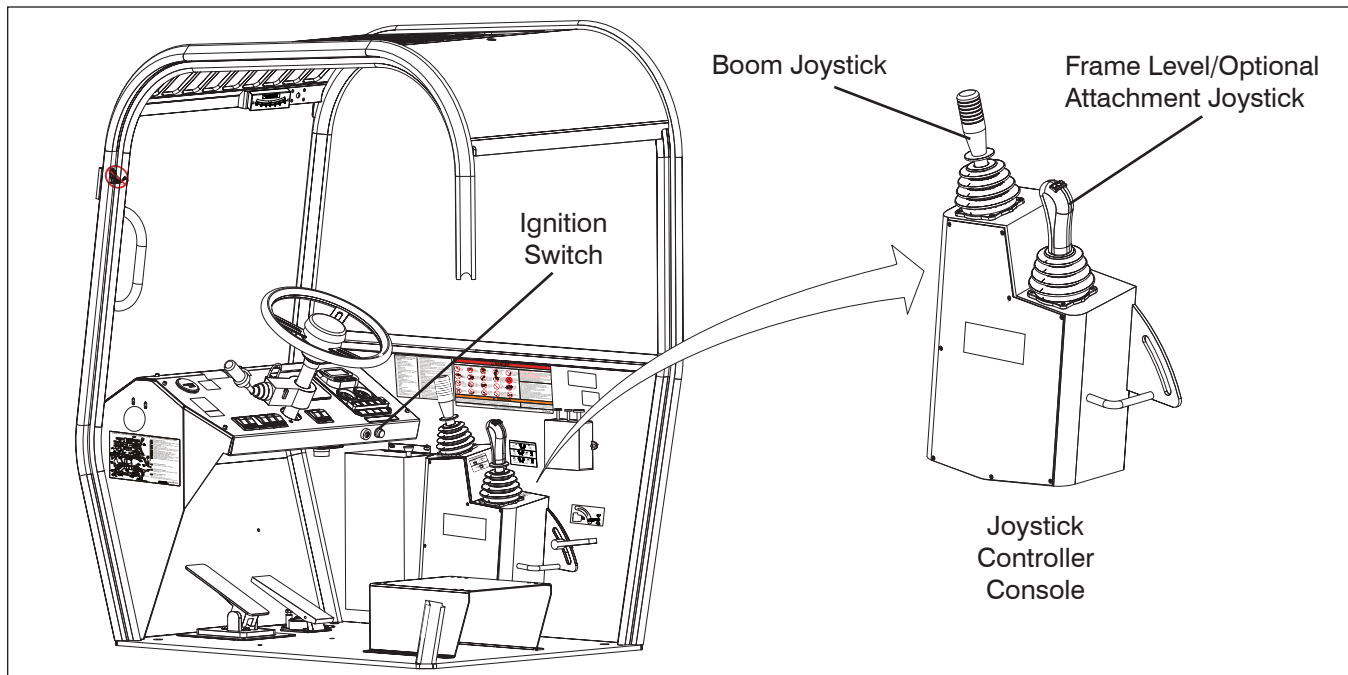

1.2 Function Tests

Function tests are designed to discover any malfunctions before telehandler is put into service. The operator must understand and follow step-by-step instructions to test all telehandler functions.

IMPORTANT

Never use a malfunctioning telehandler. If malfunctions are discovered, telehandler must be tagged and placed out of service. Repairs to telehandler may only be made by a qualified service technician.

After repairs are completed, operator must perform a pre-operation inspection and a series of function tests again before putting telehandler into service.

Prior to performing function tests, be sure to read and understand [Section 2.9](#) of the operating manual - Start Operation.



WARNING

Ensure that there are no personnel or obstructions in test area and that there is sufficient room to test all telehandler functions.

1.2--1 Operator's Cab Controls



WARNING

Ensure that you maintain three points of contact to mount/dismount the cab.

- **Test Starter Operation**

1. Enter cab and close door (if equipped).



WARNING

The seat belt must be worn at all times.

2. Sit in the driver's seat and fasten seat belt.
3. Using a spotter, adjust the mirrors.
4. Ensure parking brake is engaged.
5. Adjust the boom controller console.

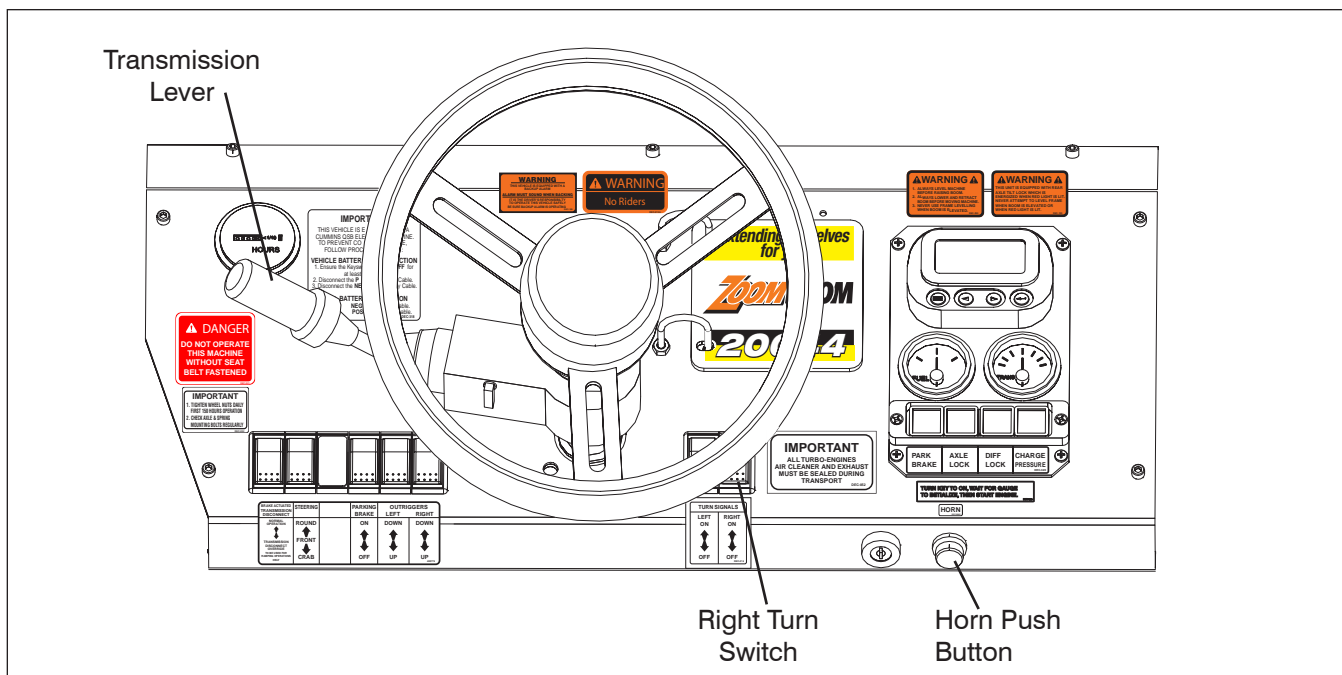

6. Insert key into ignition switch and select “I” on position. The red and amber lights at the top of electronic dash display will illuminate. Once red and amber lights are no longer displayed, and the electronic gauges are visible on the display panel; turn the key to start position.
7. Allow engine to idle for 30 seconds until low brake pressure light is off.

• Test Horn

1. Push “” horn push-button.
Result: Horn should sound.



WARNING
If the warning indicator lights illuminate when engine is running, immediately shut down the telehandler and have it serviced.

• Test Reverse Alarm

1. Ensure parking brake switch is on.
2. Depress service brake pedal and shift the transmission lever backward.
Result: The reverse alarm should sound and reverse light (if equipped) should turn on.

• Test Lights (if equipped)

1. Use a spotter to check if all the lights are working well. The spotter should maintain a safe distance from telehandler.
2. Turn parking brake switch to off position.
Result: Rear brake lights should turn off.
3. Depress service brake pedal.
Result: Rear brake lights should turn on.
4. Select head/tail light (if equipped) switch to on position.
Result: Head/tail lights should turn on.
5. Turn parking brake switch to on position.
6. Select left turn signal (if equipped) rocker switch to on position.
Result: The indicator light and left signal lights should flash.
7. Select right turn signal (if equipped) rocker switch to on position.
Result: The indicator light and right signal lights should flash.

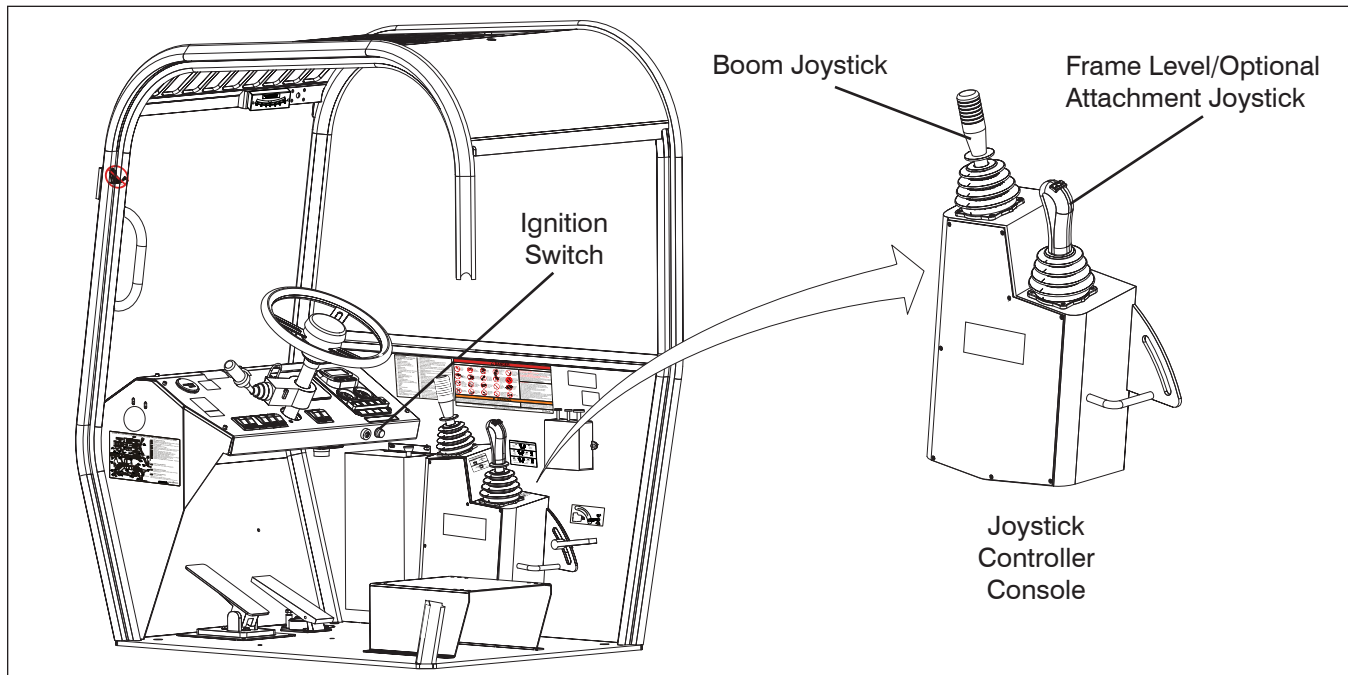

- **Test Boom and Attachment Functions**

**WARNING**

Ensure that there are no personnel or obstructions in test area and that there is sufficient room to test all telehandler functions.

1. Ensure the parking brake indicator light is on.
2. Raise the boom by pulling the boom/attachment joystick backward.
Result: Boom should raise and boom angle indicator should be functioning.
3. Extend the boom by moving the boom/attachment joystick to the right.
Result: Boom should extend and boom extension indicators are visible.

4. Tilt attachment forward by pressing and holding the thumb button while moving joystick forward.
Result: Attachment should tilt forward.
5. Tilt attachment backward by pressing and holding the thumb button while moving joystick backward.
Result: Attachment should tilt backward.
6. Retract the boom by moving the boom/attachment joystick to the left.
Result: Boom should retract.
7. Lower the boom by moving the boom/attachment joystick forward.
Result: Boom should lower.
8. Raise the boom until attachment is 2 feet above the ground.

IMPORTANT

Test all attachment functions if telehandler is equipped with optional attachments. Refer to [Section 2.14](#) in the operating manual for optional attachments operation.

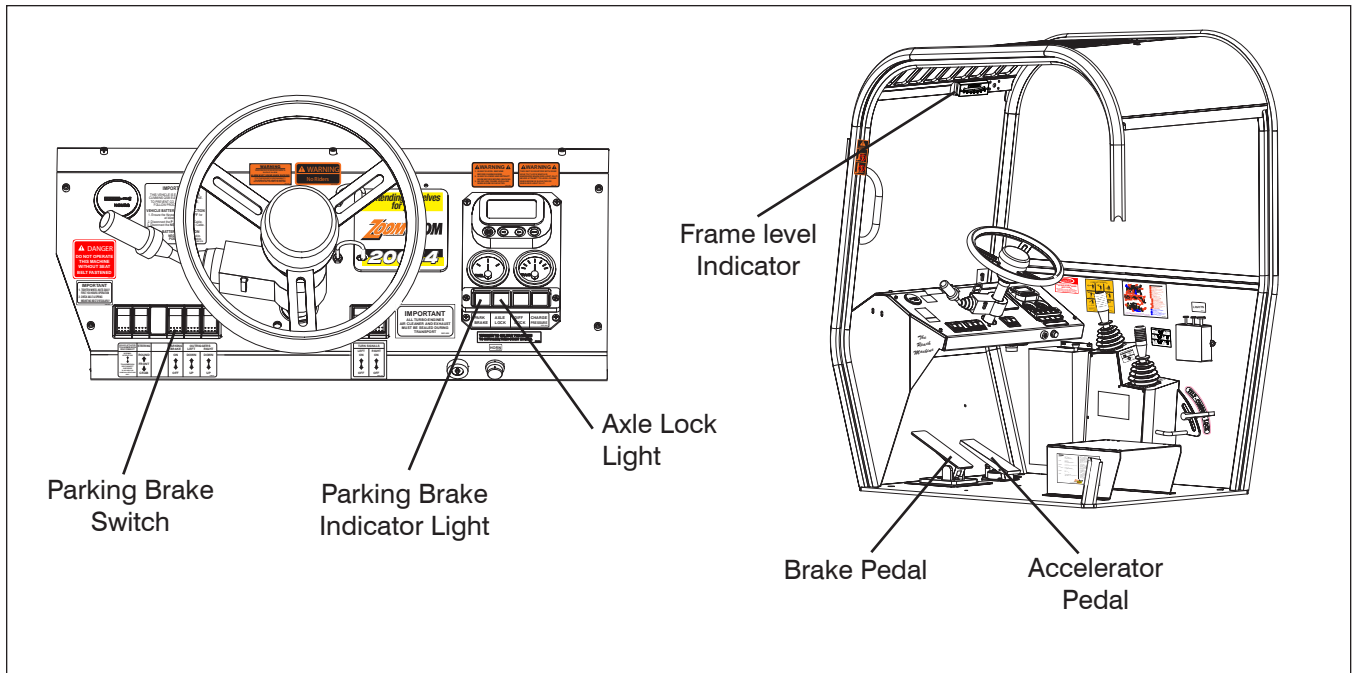

- **Test Frame Leveling and Level Indicator**

1. Ensure parking brake switch is on.
2. Tilt frame to the right by moving frame level joystick to the right.
Result: Frame should tilt to the right.
3. Tilt frame to the left by moving frame level joystick to the left.
Result: Frame should tilt to the left.
4. Use the frame level indicator to ensure frame is level.

- **Test Rear Axle Lock**

1. Ensure parking brake switch is on.
2. Raise boom above 45° - boom angle and attempt leveling the frame to the right or to the left.
Result: Rear axle lock light should illuminate and frame should not tilt to right or left.
3. Lower the boom until attachment is 2 feet above the ground.

- **Test Accelerator Pedal**

1. Ensure parking brake switch is on.
2. Depress accelerator pedal slowly.
Result: The engine RPM should increase.
3. Release the accelerator pedal.
Result: The engine RPM should decrease.

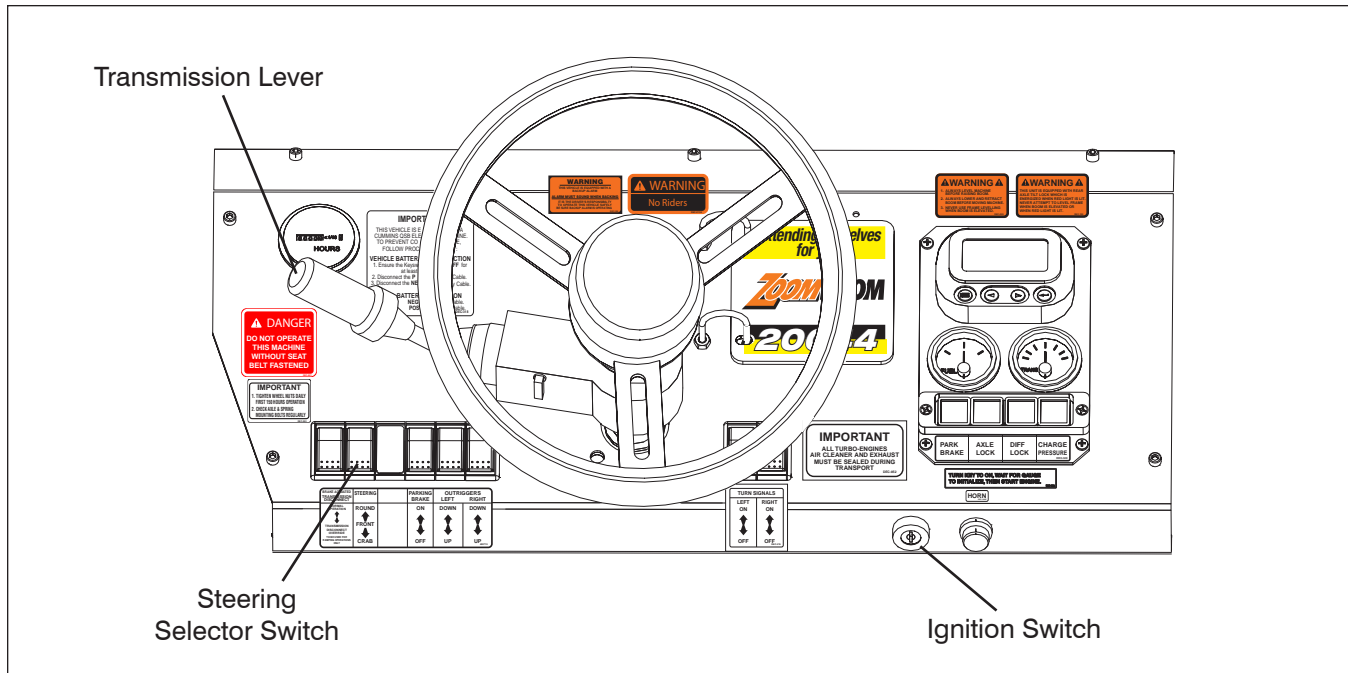

• **Test Driving & Service Brake Functions**

1. Ensure path of intended motion is clear.
2. Ensure all four wheels are aligned straight ahead.
3. Depress service brake pedal.
4. Release parking brake.
Result: Parking brake indicator light should turn off.
5. Shift transmission lever forward and release the service brake pedal slowly.
Result: Telehandler should move forward.
6. Depress service brake pedal slowly.
Result: Telehandler should stop.
7. Shift transmission lever backward and release the service brake pedal slowly.
Result: Telehandler should move backward.
8. Depress service brake pedal slowly.
Result: Telehandler should stop.
9. Return transmission lever to neutral position and engage parking brake.

• **Test Steering**



CAUTION

Before changing steering modes, bring all four wheels into alignment (i.e., in the straight-ahead position).



WARNING

Before driving on public roads and highways check the alignment of the wheels and drive with **FRONT** steering only.



WARNING

Do not change steer mode while telehandler is traveling.

NOTE

Avoid steering the wheels while telehandler is stationary.

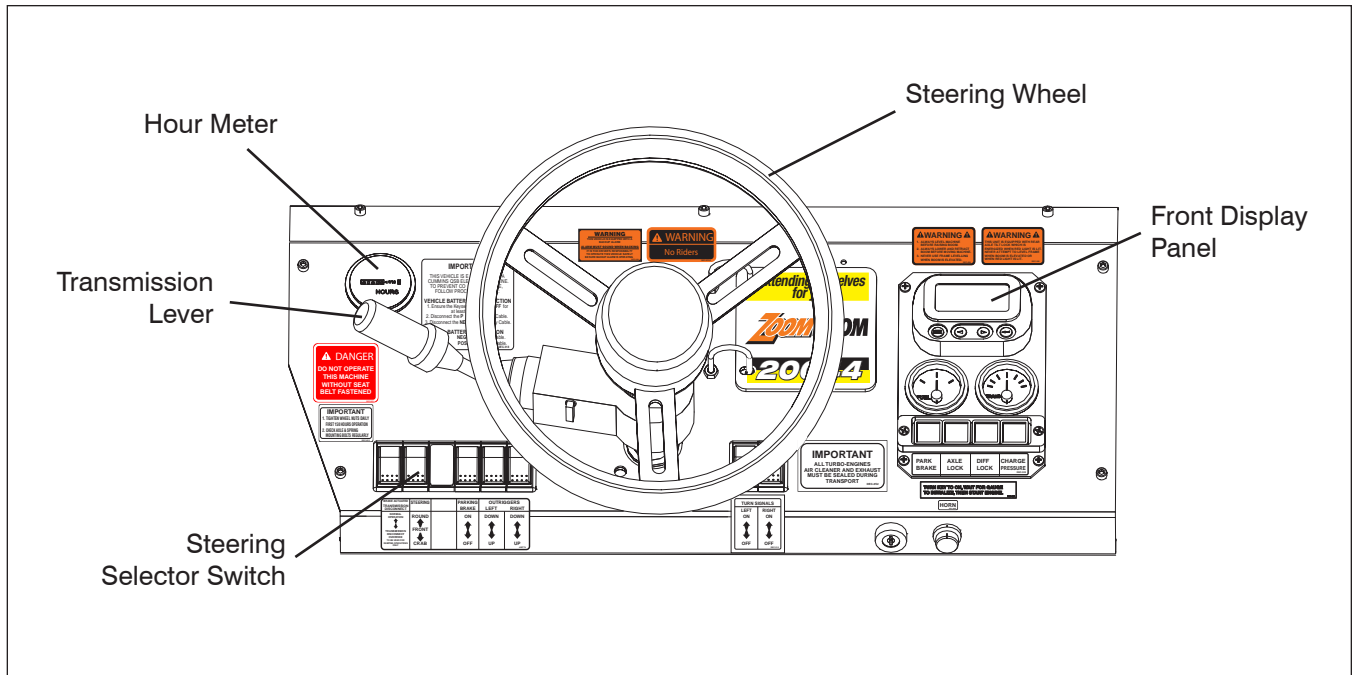

Round Steer

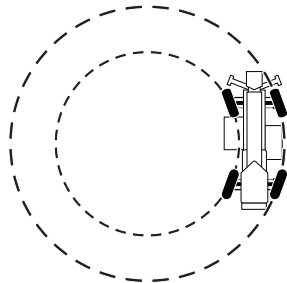



Figure 2-2 Round Steering

1. Ensure path of intended motion is clear.
2. Ensure all four wheels are aligned straight ahead.
3. Select parking brake switch to off position and depress service brake pedal.
4. Select rocker switch to forward “” position for round steering.
5. Turn the steering wheel to the left or right and drive forward.

Result: Telehandler should move in the chosen direction, producing a turning circle, with front wheels pointing in the opposite direction to the rear wheels.

6. Steer the telehandler straight ahead until all four wheels are aligned.
7. Depress service brake pedal until the telehandler stops.

Front Steer

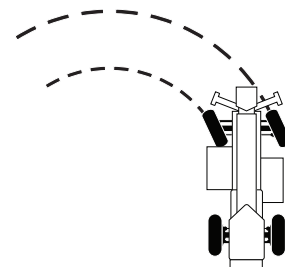

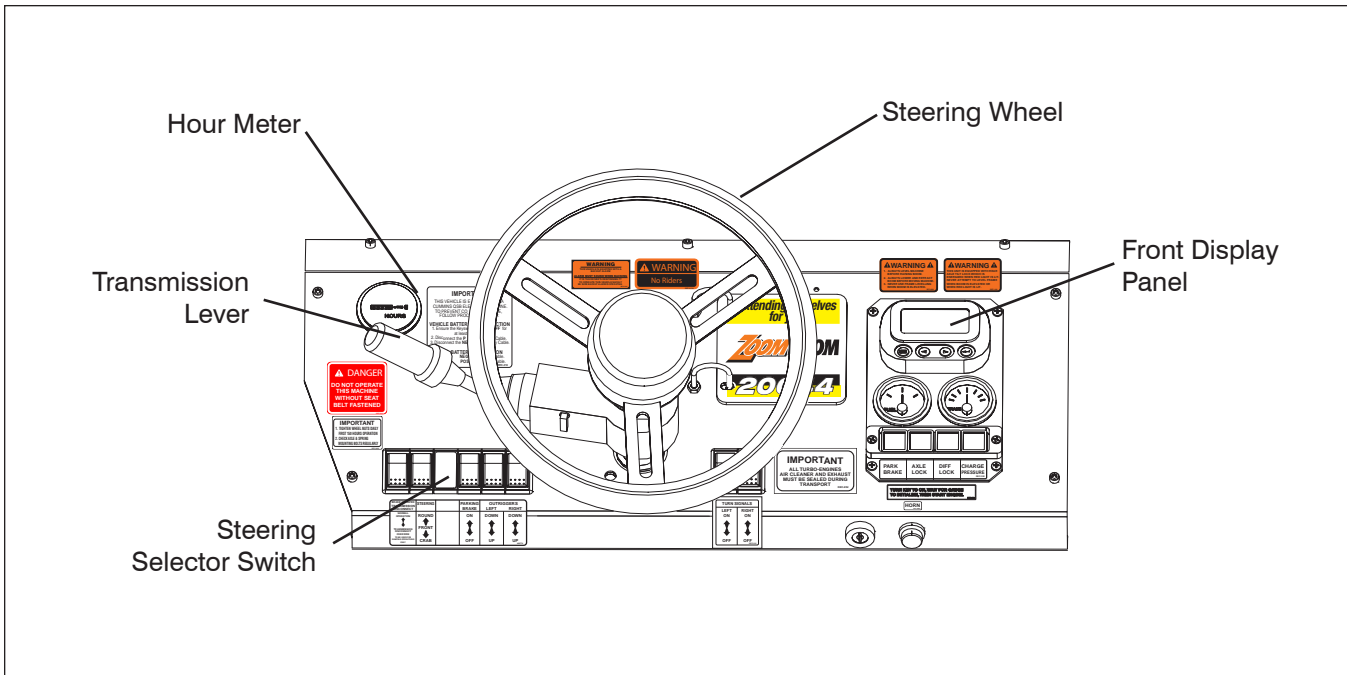

Figure 2-3 Front Steering

8. Select rocker switch to middle “” position for front steering.
9. Turn the steering wheel to the left or right and drive forward.

Result: Only front wheels of the telehandler should turn in the chosen direction.



- 10. Steer the telehandler straight ahead until all four wheels are aligned.
- 11. Depress service brake pedal until the telehandler stops.

- 13. Turn the steering wheel to the left or right and drive forward.
Result: Telehandler should move in the chosen direction with both front and rear wheels in the same direction.

Crab Steer

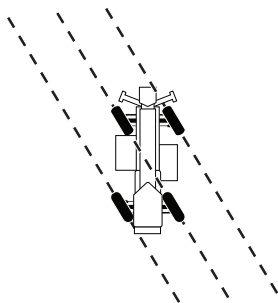

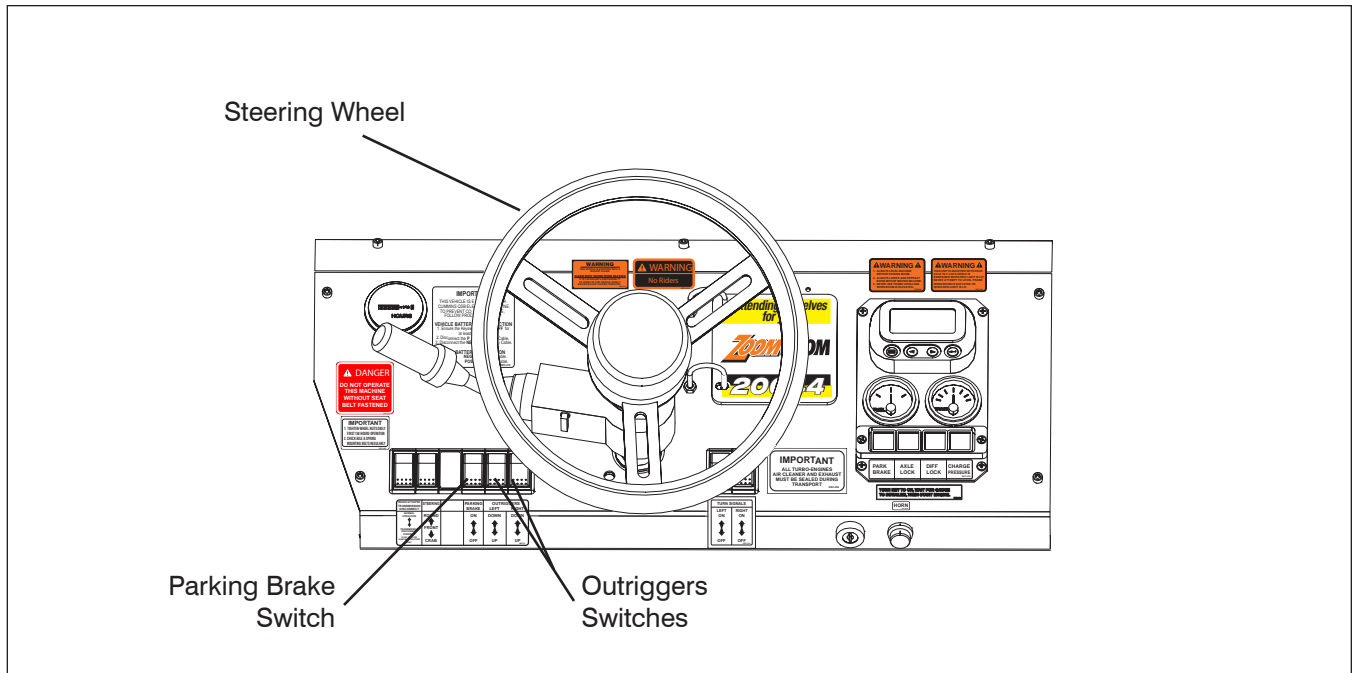

Figure 2-4 Crab Steering

- 14. Steer the telehandler straight ahead until all four wheels are aligned.
- 15. Depress service brake pedal until the telehandler stops.

- 12. Select rocker switch to backward “” position for crab steering.



- **Test Parking Brake**

**CAUTION**



Refer to Section 2.9-3 for instructions on how to drive on a slope.

1. Ensure path of intended motion is clear.
2. Ensure parking brake switch is off.
3. Drive the telehandler on a slope.
4. Depress service brake pedal slowly until telehandler stops.
5. Select parking brake rocker switch to on position and release service brake pedal.
Result: Parking brake indicator light should turn on and telehandler should not roll

- **Test Outriggers (If Equipped)**

**WARNING**

Ensure that there are no personnel or obstructions in test area and that there is sufficient room to test all telehandler functions.

1. Ensure parking brake switch is on.
2. Lower outriggers by depressing and holding rocker switch forward “” continuously.
Result: Outriggers should lower.
3. Raise outriggers by depressing and holding rocker switch backward “” continuously until outriggers are fully raised.
Result: Outriggers should raise up.

Section 2 **MAINTENANCE TABLES AND DIAGRAMS**

Table of Contents

Tables

Table 2.1 Telehandler Specifications and Features	38
Table 2.2 Recommended Fluids/Lubrication	39
Table 2.3 Axles Torque Specifications	40
Table 2.4 Tire Specifications	41
Table 2.5 Pressure Settings	42



Table 2.1 Telehandler Specifications and Features

MODEL	ZB20032	ZB20044
Engine		
Type	Cummins QSB4.5C160T3	
Max RPM	2500 rpm	
Horsepower @ 2300 RPM	168 HP	
Horsepower @ 2500 RPM	163 HP	
Fuel type	Diesel	
Transmission		
Type	DANA T32000	
Speeds forward	3	
Speeds Reverse	3	
Top Speed	20.5 mph (33 km/h)	
Gear Ratios		
1st Gear	4.64 : 1	
2nd Gear	2.23 : 1	
3rd Gear	0.82 : 1	
Electrical		
System voltage	12 volts negative ground	
Standard Batteries		
Type	HP-31E	
Quantity	2	
Cranking amperes @ 0°F (-17°C)	725 A	
Total cranking amps @ 0°F (-17°C)	1450 A	
Cranking amperes @ 32°F (0°C)	1100 A	
Reserve capacity	180 minutes	
Dimensions		
Overall length (less forks)	243 in (617 cm)	
Overall width	102 in (259 cm)	
Overall Height	108 in (274 cm)	
Curb weight (standard machine with open cab)	41,500 lbs. (18,370 kg)	45,000 lbs. (20,000 kg)
Maximum capacity	20,000 lbs. (9,071 Kg)	
Wheelbase	138 in (350 cm)	
Round steer turning Radius (inside)	220 in (559 cm)	
Boom		
Number of sections	2	3
Maximum lift height	32 ft. 4 in (985 cm)	44 ft. 10 in (1366 cm)
Maximum forward reach	16 ft 6 in (502 cm)	27 ft 5 in (835 cm)
Standard Forks	2¾ x 6 x 60 in (6.9 x 15.2 x 152.4 cm)	2¾ x 6 x 60 in (6.9 x 15.2 x 152.4 cm)
Carriage rollback	19°	19°
Carriage forward tilt	80°	80°
Operating Times		
Boom extend (at max. boom angle)	13 seconds	
Boom retract (at max. boom angle)	9.5 seconds	
Boom raise*	19 seconds	
Boom lower*	20 seconds	
Carriage roll forward	12 seconds	
Carriage roll back	12 seconds	
Frame level right (stop to stop) **	15 - 20 seconds	
Frame level left (stop to stop) **	15 - 20 seconds	

238-A

* Measured with boom fully retracted.

** Under no circumstances should the frame level cycle take less than 15 seconds to complete in either direction.

Table 2.2 Recommended Fluids/Lubrication

MODEL		ZB20032	ZB20044
Engine	Fuel Type	Diesel	
	Fuel Tank Capacity	49 gal (185 L)	
	Recommended Oil Type	15W40 CC/SF	
	Coolant Type	60/40 Ethylene glycol/distilled water	
Transmission	Type	ATF Dexron III	
	Capacity	6.3 gal (24 L)	
Axles	Differential	SAE 80W-90 GL-5	
	Planetary Wheel Ends		
Hydraulic Oil	Type	Anti-wear ISO Gr. 32	
	Tank Capacity	55 gal (208 L)	
Grease	Boom Slide Bearings	Sunaplex 992 E.P. 2	
	General Greasing	Multi Purpose E.P.	

240B

Table 2.3 Axles Torque Specifications

Size of Bolt		Type of Bolt					
		8.8		10.9		12.9	
		Normali Loctite 242 (Nm)	Loctite 270 (Nm)	Normali Loctite 242 (Nm)	Loctite 270 (Nm)	Normali Loctite 242 (Nm)	Loctite 270 (Nm)
Course Pitch	M6 x 1	9.5-10.5	10.5-11.5	14.3-15.7	15.2-16.8	16.2-17.8	18.1-20.0
	M8 x 1.25	23.8-26.2	25.6-28.4	34.2-37.8	36.7-40.5	39.0-43.0	43.7-48.3
	M10 x 1.5	48-53	52-58	68-75	73-81	80-88	88-97
	M12 x 1.75	82-91	90-100	116-128	126-139	139-153	152-168
	M14 x 2	129-143	143-158	182-202	200-221	221-244	238-263
	M16 x 2	200-221	219-242	283-312	309-341	337-373	371-410
	M18 x 2.5	276-305	299-331	390-431	428-473	466-515	509-562
	M20 x 2.5	390-431	428-473	553-611	603-667	660-730	722-798
	M22 x 2.5	523-578	575-635	746-824	817-903	893-987	974-1076
	M24 x 3	675-746	732-809	950-1050	1040-1150	1140-1260	1240-1370
	M27 x 3	998-1103	1088-1202	1411-1559	1539-1701	1710-1890	1838-2032
M30 x 3.5	1378-1523	1473-1628	1914-2115	2085-2305	2280-2520	2494-2757	
Fine Pitch	M8 x 1	25.7-28.3	27.5-30.5	36.2-39.8	40.0-44.0	42.8-47.2	47.5-52.5
	M10 x 1.25	49.4-54.6	55.2-61.0	71.5-78.5	78.0-86.0	86.0-94.0	93.0-103.0
	M12 x 1.25	90-100	98-109	128-142	139-154	152-168	166-184
	M12 x 1.5	86-95	94-104	120-132	133-147	143-158	159-175
	M14 x 1.5	143-158	157-173	200-222	219-242	238-263	261-289
	M16 x 1.5	214-236	233-257	302-334	333-368	361-399	394-436
	M18 x 1.5	312-345	342-378	442-489	485-536	527-583	580-641
	M20 x 1.5	437-483	475-525	613-677	674-745	736-814	808-893
	M22 x 1.5	581-642	637-704	822-908	903-998	998-1103	1078-1191
	M24 x 2	741-819	808-893	1045-1155	1140-1260	1235-1365	1363-1507
	M27 x 2	1083-1197	1178-1302	1520-1680	1672-1848	1834-2027	2000-2210
M30 x 2	1511-1670	1648-1822	2138-2363	2332-2577	2565-2835	2788-3082	

60571AA

Note: 1 Nm = 0.7376 ft-lb

Screw-locking, Sealing and Lubricating Materials

Loctite 242

- Anaerobic product apt to prevent the loosening of screws, nuts and plugs. Used for medium-strength locking. Before using it, completely remove any lubricant by using the specific activator.

Loctite 270

- Anaerobic product apt to prevent the loosening of screws, nuts and plugs. Used for medium-strength locking. Before using it, completely remove any lubricant by using the specific activator. To remove parts, it may be necessary to heat them at 80 °C approx.

Table 2.4 Tire Specifications

Standard Tires	
Tire Size	17.50 - 25
Pressure	90 psi
Tire Ply Rating	16 PR
Wheel Nuts Torque	450 - 500 ft.lb

239A

**WARNING**

Intermixing tires of different types or using tires of types other than those originally supplied with this equipment can adversely affect stability. Therefore, replace tires only with the exact original Skyjack-approved type. Failure to operate with matched approved tires in good condition may result in death or serious injury.

IMPORTANT

For proper function of each axle differential, all four wheels must have same tire size installed at all times. Failure to comply with this requirement will reduce the life of the differentials and reduce overall mobility of telehandler.

Table 2.5 Pressure Settings

Model ZB20044			
Maximum Pump Pressure	P1		3150 psi
	P2		3200 psi
Stand-by Pump Pressure	P1		500 psi
	P2		550 psi
Lift	Maximum pump pressure controlled		3200 psi
			3200 psi
Extension	Maximum pump pressure controlled		3200 psi
			3200 psi
Carriage Tilt Cylinder	Port Relief	Rod End	3100 psi
		Base End	1500 psi
	Crossover Relief	Rod End	3400 psi
		Base End	1800 psi
Frame Level Cylinder	Port Relief	Rod End	1500 psi
		Base End	1500 psi
Auxiliary Hydraulics	Port Relief	Rod End	2000 psi
		Base End	2000 psi
Outrigger	Port Relief	Rod End	2500 psi
		Base End	2500 psi
Pressure Reducing Valve	Pilot Pressure		325 psi
Priority Valve Pressure Relief	Steering Pressure		2800 psi

250A

Note: all pressure settings to be checked at idle

Section 3

SYSTEM COMPONENT IDENTIFICATION AND SCHEMATICS

Table of Contents

Charts

























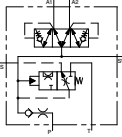



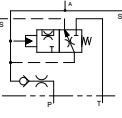



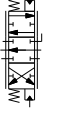



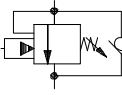

3.1 Hydraulic Symbol Chart	45
3.2 Electrical Symbol Chart.....	46
3.3 Harnesses Color Codes	47

Diagrams and Schematics



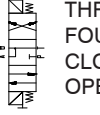

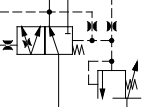
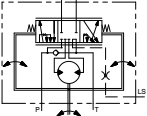

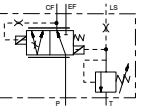









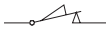





















3.4 Hydraulic Schematic Parts List	49
3.5 Electrical Component Parts List	52
3.5 Electrical Component Parts List (Continued).....	53
3.5 Electrical Component Parts List (Continued).....	54
3.6 Priority Valve and Port Identifications	55
3.7 Steering Valve and Port Identifications.....	56
3.8 Diverter Valve and Port Identifications.....	57
3.9 Parking Brake Valve and Port Identifications	58
3.10 Brake Charge Valve and Port Identifications	59
3.11 Frame Level and Axle Lock Valves and Port Identifications.....	60
3.12 Cross-Over Relief Valve and Port Identifications.....	61
3.13 Dual Charge Brake Pedal and Port Identifications.....	62
3.14 Orbital Steering Motor and Port Identifications.....	63
3.15 Main Valve and Main Ports Identifications.....	65
3.16 Hydraulic Cylinders Identification.....	67
3.17 Hydraulic Manifolds Location.....	68
3.18 Instrument Panel Wiring Diagram (Base Model)	69
3.19 Main Wiring Harness	71
3.20 Engine Harness (QSB4.5 Tier 3)	72
3.21 Transmission T32000 Harness	73
3.22 Frame Level Harness	74
3.23 Axle Lock Harness.....	75
3.24 Diverter Valve Harness, 2-Way.....	76
3.25 Parking Brake Harness.....	77
3.26 Steering Harness	78
3.27 Horn, Fuel & Brake Pressure Switch Harness.....	79
3.28 Joystick with Horizontal Rocker Switch.....	80
3.29 Three-Speed Shifter	81
3.30 Joystick, Two-Axis with Microswitch	82
3.31 Power Module - Enclosed Cab Harnesses	83
3.32 Power Module - Open Cab Harnesses	84
3.33 Lighting Harness.....	85
3.34 Wiper Harness.....	86
3.35 Grapppler Harness	87
3.36 Outrigger Raise/Lower Harness.....	88
3.37 Mine Spec. - Brakes Harness	89
3.38 Mine Spec. - Pressure Switches Harness	90
3.39 Mine Spec. - Steering Accumulator Harness	91
3.40 Hydraulic Schematic.....	92
3.41 Master Wiring Diagram	93

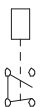
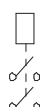

3.1 Hydraulic Symbol Chart

	LINE CROSSING		HAND PUMP		ACCUMULATOR, GAS CHARGED		SINGLE ACTING CYLINDER
	LINE JOINED		RELIEF VALVE		PRESSURE SWITCH		DOUBLE ACTING CYLINDER
	HYDRAULIC TANK		PRESSURE REDUCING VALVE		SHUTTLE VALVE		DOUBLE ACTING DOUBLE RODDED CYLINDER
	HYDRAULIC FILTER WITH BYPASS		FIXED ORIFICE		CHARGE VALVE DUAL		SPRING APPLIED HYDRAULIC RELEASED BRAKE
	ELECTRIC MOTOR		ADJUSTABLE FLOW CONTROL		CHARGE VALVE SINGLE		BRAKE CYLINDER
	ENGINE		CHECK VALVE		THREE POSITION SIX WAY OPEN CENTER CLOSED PORT		TWO POSITION TWO WAY NORMALLY OPEN VALVE
	FIXED DISPLACEMENT PUMP		OIL COOLER		COUNTER BALANCE VALVE		MAIN LINES Solid
	VARIABLE DISPLACEMENT PUMP		TWO POSITION THREE WAY VALVE		VALVE COIL		PILOT LINES Dashed
	VARIABLE DISPLACEMENT HYDRAULIC MOTOR		TWO POSITION TWO WAY NORMALLY CLOSED VALVE		THREE POSITION FOUR WAY CLOSED CENTER OPEN PORT		
	BI DIRECTIONAL HYDRAULIC MOTOR		THREE POSITION FOUR WAY CLOSED CENTER CLOSED PORT		DYNAMIC SIGNAL PRIORITY VALVE		
	ORBITAL STEERING MOTOR		PRESSURE TRANSDUCER		STATIC SIGNAL PRIORITY VALVE		

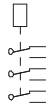
3.2 Electrical Symbol Chart

 CIRCUIITS CROSSING NO CONNECTION	 HOURMETER	 KEY SWITCH	 LIMIT SWITCH N.O.
 CIRCUIITS CONNECTED	 LIGHT	 FOOT SWITCH	 LIMIT SWITCH N.O. HELD CLOSED
 BATTERY	 HYDRAULIC VALVE COIL	 TOGGLE SWITCH	 LIMIT SWITCH N.C.
 GROUND	 PROPORTIONAL HYDRAULIC VALVE COIL	 PUSH BUTTON	 LIMIT SWITCH N.C HELD OPEN
 FUSE	 ELECTRIC MOTOR	 ROTARY SWITCH	 SILICON CONTROLLED RECTIFIER
 CIRCUIT BREAKER	 HORN	 LIMIT SWITCH	 PROXIMITY SWITCH
 VOLT METER	 EMERGENCY STOP BUTTON	 CAM OPERATED LIMIT SWITCH	 PNP TRANSISTOR
 CAPACITOR	 RESISTOR	 TILT SWITCH	 NPN TRANSISTOR
 POTENTIOMETER	 LEVEL SENSOR	 SINGLE POLE SINGLE THROW RELAY	 PRESSURE VACUUM SWITCH
 SINGLE POLE DOUBLE THROW RELAY	 DOUBLE POLE SINGLE THROW RELAY	 DOUBLE POLE DOUBLE THROW RELAY	 TEMPERATURE SWITCH
 TRIPLE POLE DOUBLE THROW RELAY	 DIODE	 RHEOSTAT	

3.3 Harnesses Color Codes

FUNCTION	WIRE COLOR
GROUND	BLK
FROM ALTERNATOR B+ TO STARTER MOTOR	RED
FROM ACC ON KEY SWITCH TO BREAKER BUS BAR	RED
IGNITION	YEL
OIL TEMPERATURE (TRANSMISSION)	BRN/RED
STARTER SOLENOID	GRN
HORN	PNK
FUEL GAUGE	GRY
BRAKE PRESSURE WARNING LIGHT	BLU
STEERING	
FROM BREAKER TO STEERING SWITCH	GRN/YEL
ROUND STEER	GRN/BLK
CRAB STEER	GRN/WHT
PARK BRAKE	
FROM BREAKER TO PARK BRAKE SOLENOID	LT BLU/RED
FROM SWITCH TO PARK BRAKE SOLENOID	LT BLU
FROM SWITCH TO PARK BRAKE LIGHT	LT BLU/BLK
FROM SWITCH TO DECLUTCH RELAY	LT BLU/BLK
FROM SWITCH TO PARK BRAKE OFF	LT BLU/BLK
TRANSMISSION	
FORWARD SOLENOID	RED
REVERSE SOLENOID	WHT
1 st SOLENOID	BRN
2 nd SOLENOID	BLK
DIVERTER VALVE	TAN
ALTERNATOR EXCITER	PUR

FUNCTION	WIRE COLOR
DASH POWER	
TO HOUR METER	BLU/YEL
TO HORN	BLU/WHT
TO INSTRUMENT CLUSTER (exclude PV100)	BLU/RED
DIFFERENTIAL LOCK	
FROM BREAKER TO TO DIFF. LOCK SWITCH	LT GRN
FROM SWITCH TO DIFF. LOCK SOLENOID	
FROM DIFF. LOCK SWITCH TO INSTRUMENT CLUSTER	LT GRN/RED
FRAME LEVEL/AXLE LOCK	
FROM BREAKER TO AXLE LOCK RELAY	YEL/BLK
AXLE LOCK LIGHT	YEL/BLU
OUTRIGGERS	
FROM BREAKER TO BOX	WHT
FROM BOX TO OUTRIGGER SWITCHES	WHT/BLU
FROM 400425 BOX TO DUMP VALVE	WHT/GRY
LEFT UP	WHT/BLK
LEFT DOWN	WHT/BLK/RED
RIGHT UP	WHT/RED
RIGHT DOWN	WHT/RED/GRN
FROM 401392 HARNESS TO LIFT CYLINDER PRESS OR PROXIMITY SWITCHES	WHT/ORG
OPTIONAL LIGHTS	
HEADLIGHTS	ORG/GRN
HEADLIGHTS AND TAILLIGHTS	ORG/BLK/WHT
BRAKE LIGHTS	ORG/RED
SIGNAL LIGHTS	ORG
LEFT FRONT & LEFT REAR	ORG/BLK
RIGHT FRONT & RIGHT REAR	ORG/BLU

225A

This table is to be used as a wire function/color reference for all electrical drawings and schematics.

3.4 Hydraulic Schematic Parts List

Index No.	Skyjack Part No.	Qty.	Description
ACC1	400947	1	ACCUMULATOR, Joystick
ACC2	400947	1	ACCUMULATOR, Brake Charge
ACC3	400947	1	ACCUMULATOR, Brake Charge
ACC4	400947	1	ACCUMULATOR, Rear axle lock
C1	9-180	1	CYLINDER, Front steer (LH) (Part of axle assembly)
C2	9-180	1	CYLINDER, Front steer (RH) (Part of axle assembly)
C3	9-180	1	CYLINDER, Rear steer (RH) (Part of axle assembly)
C4	9-180	1	CYLINDER, Rear steer (LH) (Part of axle assembly)
C5	401061	1	CYLINDER, Boom lift
C6	401061	1	CYLINDER, Boom lift
C7	9-163	1	CYLINDER, Boom extension
C8	9-158	1	CYLINDER, Slave
C9	9-158	1	CYLINDER, Slave
C10	9-158	1	CYLINDER, Carriage Tilt
C11	9-158	1	CYLINDER, Carriage Tilt
C12	9-161	1	CYLINDER, Frame Level (Right)
C13	9-161	1	CYLINDER, Frame Level (Left)
C14	9-155	1	CYLINDER, Rear axle lock
C15	9-160	1	CYLINDER, Left outrigger
C16	9-160	1	CYLINDER, Right outrigger
C17	-	1	CYLINDER, Parking Brake (Part of front axle only)
C18	9-101	1	CYLINDER, Carriage shift (Optional)
C19	401401	1	CYLINDER, Fork shift (Optional fork/side shift carriage)
C20	401401	1	CYLINDER, Fork shift (Optional fork/side shift carriage)
C21	-	1	CYLINDER, Clamp (Optional rotating pipe & pole grapppler)
C22	-	1	CYLINDER, Clamp (Optional rotating pipe & pole grapppler)
C23	-	1	CYLINDER, Rotate (Optional rotating pipe & pole grapppler)
C24	-	1	CYLINDER, Clamp (Optional 2 stage pipe & pole grapppler)
C25	-	1	CYLINDER, Clamp (Optional 2 stage pipe & pole grapppler)
CB1	CAGALHN- CBGALHN- YVSNB120	1	VALVE, Counterbalance (Lift cylinder)
CB2	CAGALHN- CBGALHN- YVSNB120	1	VALVE, Counterbalance (Lift cylinder)
CB3	CAGALHN- CBGALHN- YVSNB120	1	VALVE, Counterbalance (Boom extension cylinder)
CB4	CX434_A	1	VALVE, Counterbalance (Carriage tilt cylinder)
CB5	CBCH-LJN-YY	1	VALVE, Counterbalance (Right, Frame level cylinder)
CB6	CBCH-LJN-YY	1	VALVE, Counterbalance (Left, Frame level cylinder)
CB7	CBCH-LJN-YY	1	VALVE, Counterbalance (Right outrigger)
CB8	CBCH-LJN-YY	1	VALVE, Counterbalance (Left outrigger)
CRV1	133603	1	VALVE, Crossover relief
CV1	3C14-12T-65	1	VALVE, Check
CV2	3C14-12T-65	1	VALVE, Check
F1	149177	1	FILTER, Return line

Parts list continued on following page.

3.4 Hydraulic Schematic Parts List (Continued)

Index No.	Skyjack Part No.	Qty.	Description
Parts list continued from previous page.			
JS1	401473	1	JOYSTICK, Rear
JS2	401349	1	JOYSTICK, Front
MB1	WA10-175-1	1	MANIFOLD, Return
OSM1	21-1085-002	1	MOTOR, Drive Steering
P1 thru	78493-RAJ	1	PUMP, Hydraulic gear (Front)
P2	78493-RAJ	1	PUMP, Hydraulic gear (Rear)
PRV1	RD10A_0S1B_J11	1	VALVE, Pressure reduce
PRT1	402902	1	VALVE, Priority
PS1	DNB-150-K	1	SWITCH, Pressure
PS2	20-580-038	1	SWITCH, Pressure
PS3	20-580-038	1	SWITCH, Pressure
PS4	20-580-038	1	SWITCH, Pressure
RV1	-	1	VALVE, Relief (Part of priority valve)
RV2 thru			
RV11	-	1	VALVE, Relief (Part of main valve)
QD1 thru			
QD2	FD45-1040-02	AR	QUICK DISCONNECT
QD3 thru			
QD4	FD45-1040-02	1	QUICK DISCONNECT
QD5 thru			
QD10	2071-4-4	1	QUICK DISCONNECT
STR1	FST212-1SA	1	SUCTION STRAINER
STR2	FST212-1SA	1	SUCTION STRAINER
SV1	VFC-NC-14	1	VALVE, Shuttle
SV2	VFC-NC-14	1	VALVE, Shuttle
SV3	VFC-NC-14	1	VALVE, Shuttle
TP1 thru	FD45-1002	5	TEST PORT
TP6	-02-02		
V1	DSG-3C60-01-D1-2090	1	VALVE, Steering function
V2	DFE5_6H18ES-Y202	1	VALVE, Diverter
V3	06-463-100	1	VALVE, Charge
Parts list continued on following page.			

3.4 Hydraulic Schematic Parts List (Continued)

Index No.	Skyjack Part No.	Qty.	Description
Parts list continued from previous page.			
V4	403338	1	VALVE, Dual brake pedal
V5	DSG-3C4-N01-D1-2090	1	VALVE, Park brake
V6	DFE5_6H18 ES-Y202	1	VALVE, Diverter
V7 thru V10	9S002904A	4	VALVE, Dump, Frame level
V11 thru V14	9S000469A	1	VALVE, Axle lock

3.5 Electrical Component Parts List

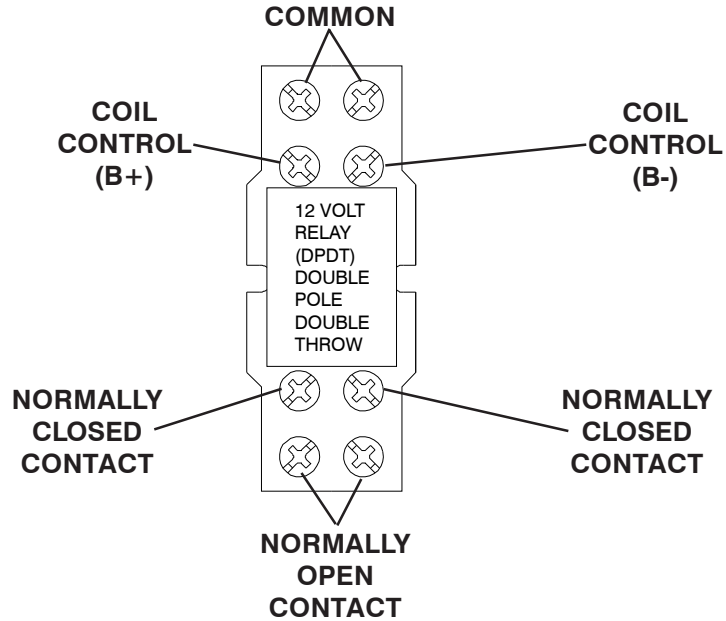
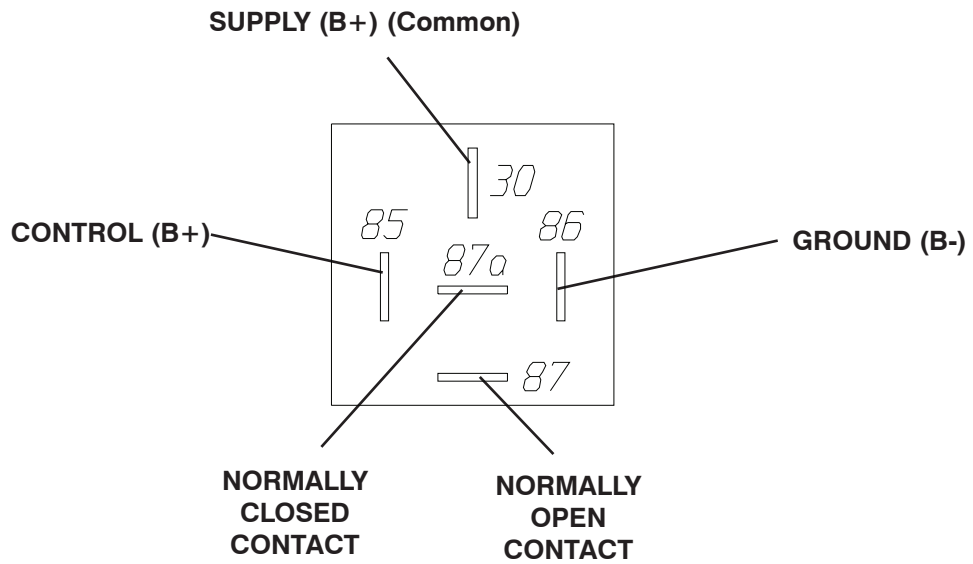

3.5 Electrical Component Parts List (Continued)

Index No.	Skyjack Part No.	Qty.	Description
CB1	30055-6	1	CIRCUIT BREAKER, Self resetting (6 A), Diverter valve
CB3	30055-6	1	CIRCUIT BREAKER, Self resetting (6 A), Outtrigger
CB4	661-10	1	CIRCUIT BREAKER, Self resetting (10 A), Transmission shifter
CB5	661-10	1	CIRCUIT BREAKER, Self resetting (10 A), Dash power
CB6	661-10	1	CIRCUIT BREAKER, Self resetting (10 A), Parking brake
CB7	661-20	1	CIRCUIT BREAKER, Self resetting (20 A), Signal lights
CB8	30055-6	1	CIRCUIT BREAKER, Self resetting (6 A), Alternator
CB9	661-20	1	CIRCUIT BREAKER, Self resetting (20 A), Axle lock/Frame leveling
CB10	30055-6	1	CIRCUIT BREAKER, Self resetting (6 A), Steering
CB11	661-10	1	CIRCUIT BREAKER, Self resetting (10 A), Auxiliary hydraulic
CB15	661-20	1	CIRCUIT BREAKER, Self resetting (20 A), Light power
CB16	661-20	1	CIRCUIT BREAKER, Self resetting (20 A), Heater power
CB17	661-20	1	CIRCUIT BREAKER, Self resetting (20 A), Wiper power
CB18	661-20	1	CIRCUIT BREAKER, Self resetting (20 A), Boom light power
CB21	661-20	1	CIRCUIT BREAKER, Self resetting (20 A), Aux light power
CB23	661-30	1	CIRCUIT BREAKER, Self resetting (30 A)
CB220	661-50	2	CIRCUIT BREAKER, Self resetting (50 A)
DXX	102921	AR	DIODE
F1	ATC5	1	FUSE, 5 Amp
F2	ATC5	1	FUSE, 5 Amp
F64	AGC4A	1	FUSE, 4 Amp
F66	AGC4A	1	FUSE, 4 Amp
F70	AGC4A	1	FUSE, 4 Amp
F100 thru	ATC5	1	FUSE, 5 Amp
F104			
F201	-	1	FUSE, 5 Amp
F279	-	1	FUSE, 30 Amp
F300	0298125	1	FUSE, 125 Amp
H1	19-1040	1	HORN, 12 Volt,
K1	0332-019-110	1	RELAY, Transmission disconnect, 10 Amp, 12V,
K13 , K14	CCP012D	2	RELAY, Power module
K15	0-1432772-1	1	RELAY, (SPST-NO, 40A, 12 VDC)
K16	0332-019-110	1	RELAY, Enclosed cab power module
K20	0332-019-110	1	RELAY, 12V, Shifter (Neutral Safety)
K124	4210835	1	SOLENOID, Steering "A"
K125	4210835	1	SOLENOID, Steering "B"
K127	-	1	COIL, Upper, part of parking brake valve V6
K128	-	1	COIL, Lower, part of parking brake valve V6
K134	V.813-12VDC- SD10-11-16	1	COIL, Right lower
K135	V.813-12VDC- SD10-11-16	1	COIL, Right lower
K140 thru	CCP012D	4	COIL, Frame leveling
K143			
K210 thru	CCP012D	1	COIL, Axle lock
K213			
K220	-	1	SOLENOID, Starter
K221	LY2	1	RELAY, DPDT

Parts list continued on following page.

3.5 Electrical Component Parts List (Continued)

Index No.	Skyjack Part No.	Qty.	Description
Parts list continued from previous page			
K222	DFE5/6H18ES- Y202	1	COIL, Diverter valve
K267	4210835	1	SOLENOID, First, Transmission
K268	4210835	1	SOLENOID, Second, Transmission
K269	4210835	1	SOLENOID, Forward, Transmission
K270	4210835	1	SOLENOID, Reverse, Transmission
K380	-	1	COIL, 3-way diverter valve
K381	-	1	COIL, 3-way diverter valve
M	892032	1	HEATER, Optional
M1	85099	1	HOUR METER
M2	457-CE	1	GAUGE, S-W Fuel level
M3	467-JL	1	GAUGE, 140-320 Transmission oil temperature
PS1	24-725	1	BATTERY (12 V, 725CCA)
PS2	24-725	1	BATTERY (12V, 725 CCA))
R208	391D	1	FUEL SENDER
R223	334J	1	TEMPERATURE SENDER
SW1	956-3126	1	SWITCH, Ignition
SW2	19-1040	1	SWITCH, Horn
SW3	58031-01	1	SWITCH, Rocker (transmission disconnect)
SW4	58031-02	1	SWITCH, Rocker SPCO (steering mode selector)
SW6	58031-03	1	SWITCH, Rocker SPDT (park brake)
SW7	58031-08	1	SWITCH, Rocker momentary (Left outrigger)
SW8	58031-08	1	SWITCH, Rocker momentary (Right outrigger)
SW9	58031-01	1	SWITCH, Rocker (Left turn signal)
SW10	58031-01	1	SWITCH, Rocker (Right turn signal)
SW15	660-135	1	SWITCH, (Push-pull, 75A) lights
SW18	660-135	1	SWITCH, Boom lights
SW19	660-135	1	SWITCH, Aux lights
SW62	193362	1	LIGHT, Interior (dome)
SW64	P190130	1	MOTOR, Top wiper
SW66	P190130	1	MOTOR, Front wiper
SW68	193876	1	FAN, Ventilation
SW69	1151	1	SWITCH, Heater fan
SW70	P190130	1	MOTOR, Rear wiper
SW114	DNB-070- 22B-NPT	1	SWITCH, Park brake pressure
SW122	DNB-150- 22B-NPT	1	SWITCH, Pressure (Brake charge)
SW125	DNB-070- 22B-NPT	1	SWITCH, Pressure (Reverse Alarm)
SW150	32-580-002	1	SWITCH, Brake light pressure
SW305	402742	1	SWITCH, Battery Disconnect Optional
SW360	A1002	1	SWITCH, Mercury, Boom angle

3.6 Priority Valve and Port Identifications

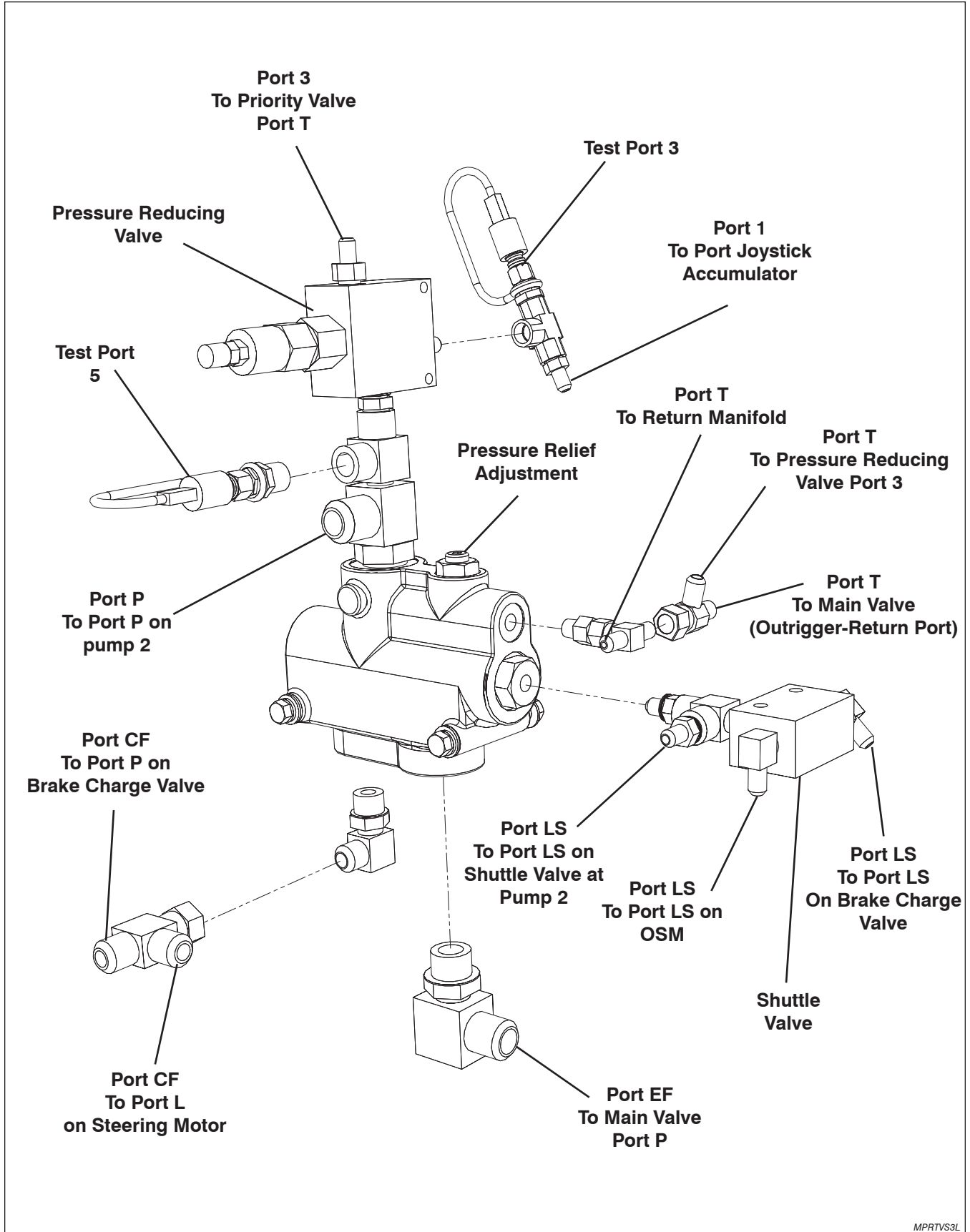

MPRTVS3L

3.7 Steering Valve and Port Identifications

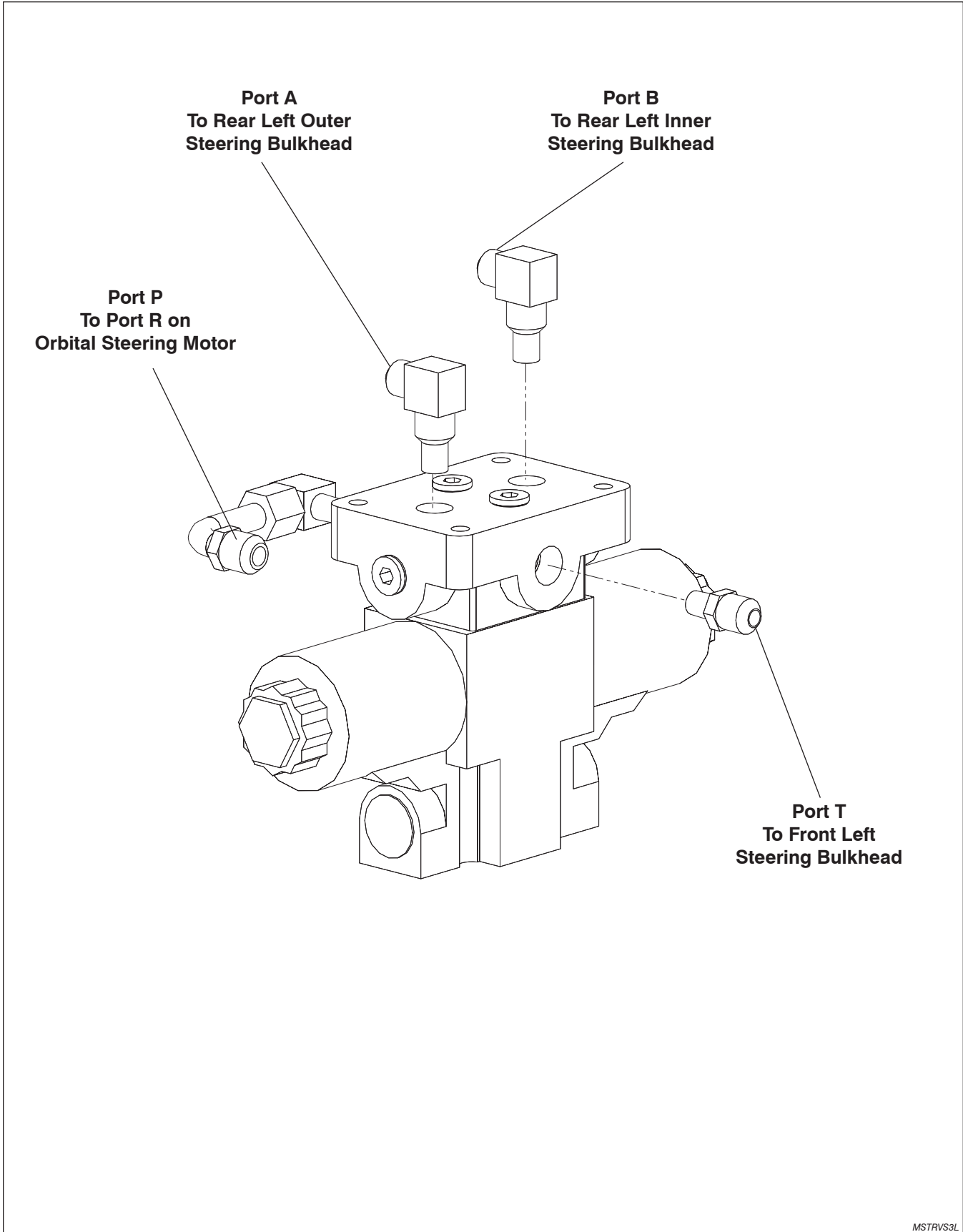

MSTRVS3L

3.8 Diverter Valve and Port Identifications

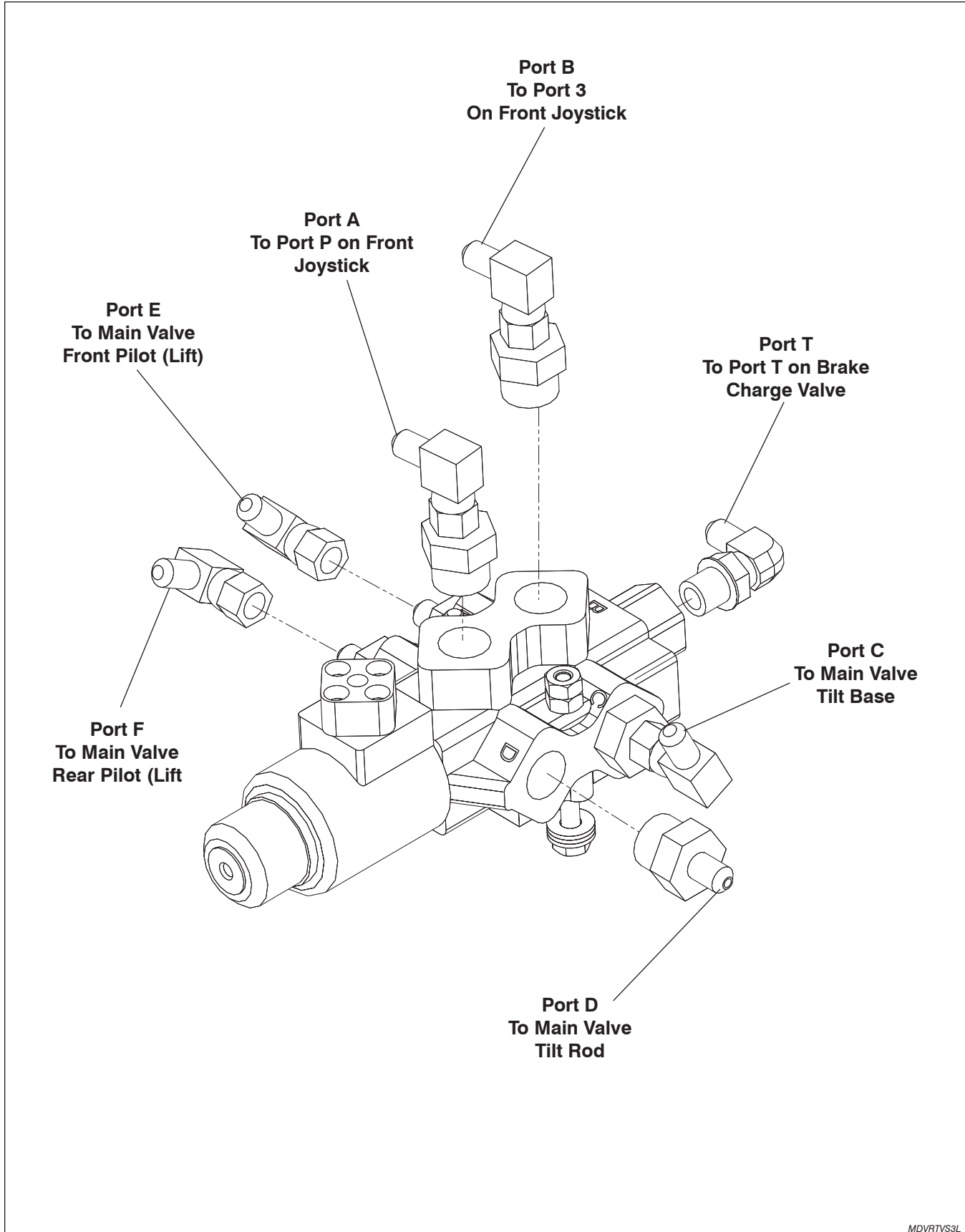

MDVRTVS3L

3.9 Parking Brake Valve and Port Identifications

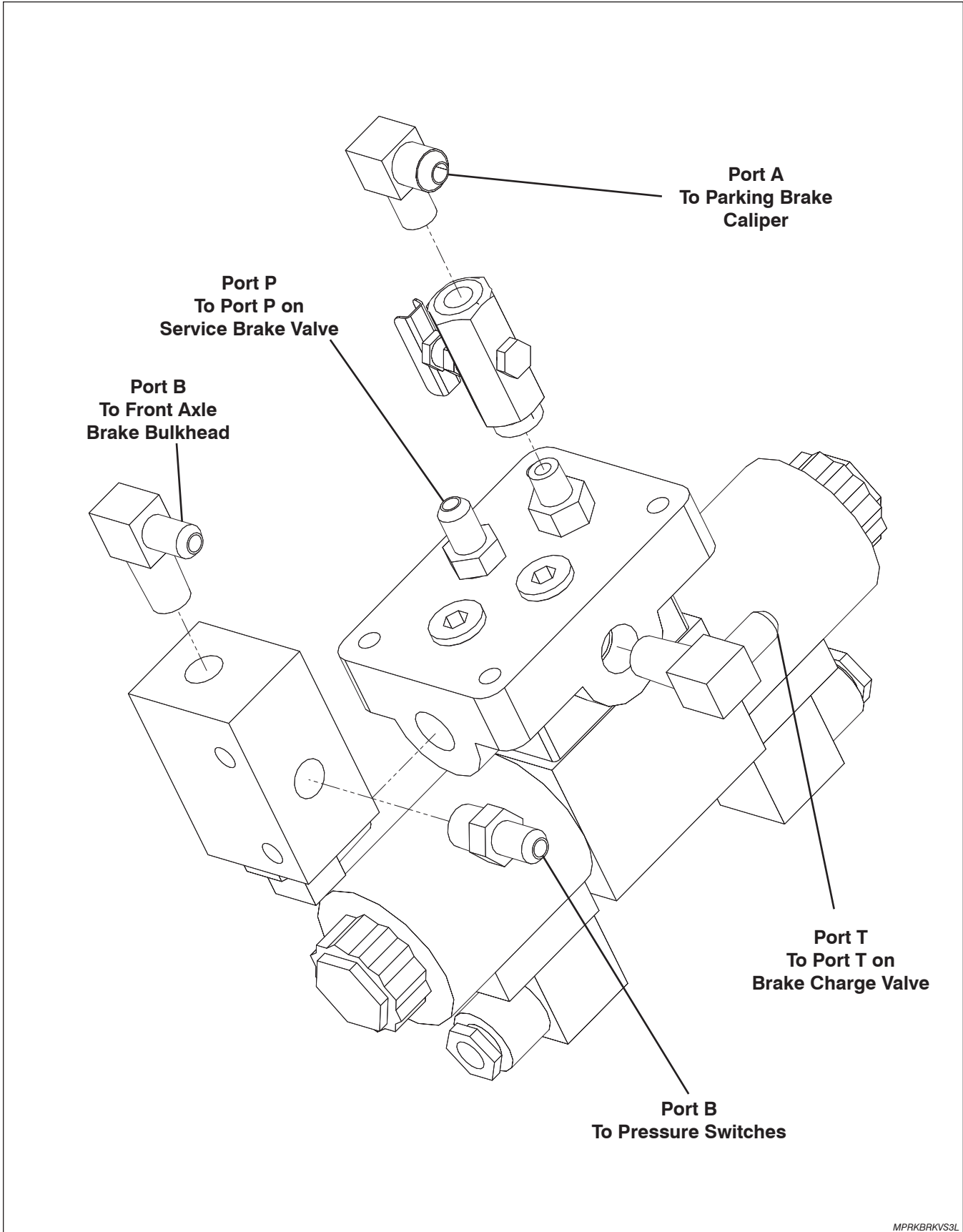

3.10 Brake Charge Valve and Port Identifications

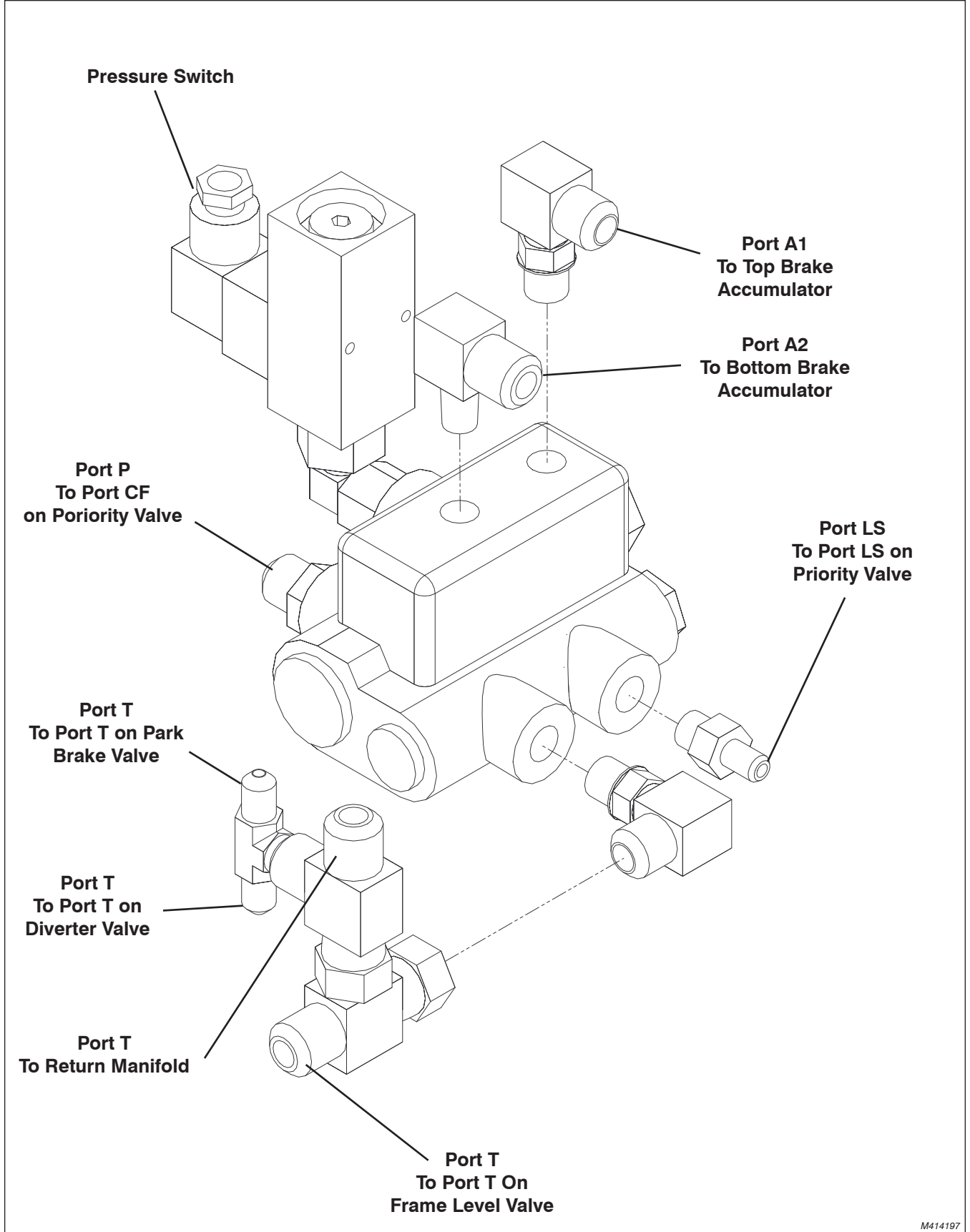

M414197

3.11 Frame Level and Axle Lock Valves and Port Identifications

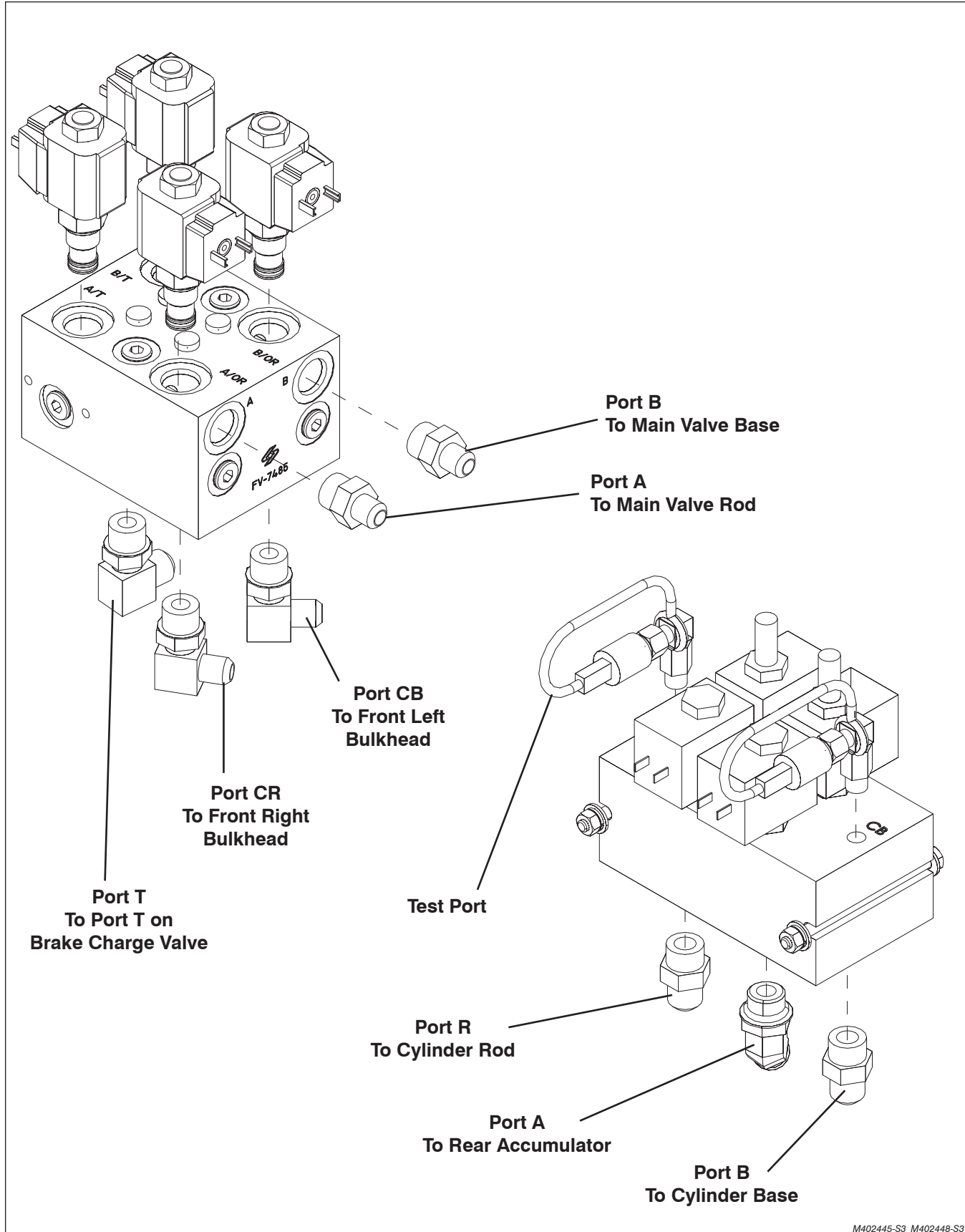

M402445-S3_M402448-S3

3.12 Cross-Over Relief Valve and Port Identifications

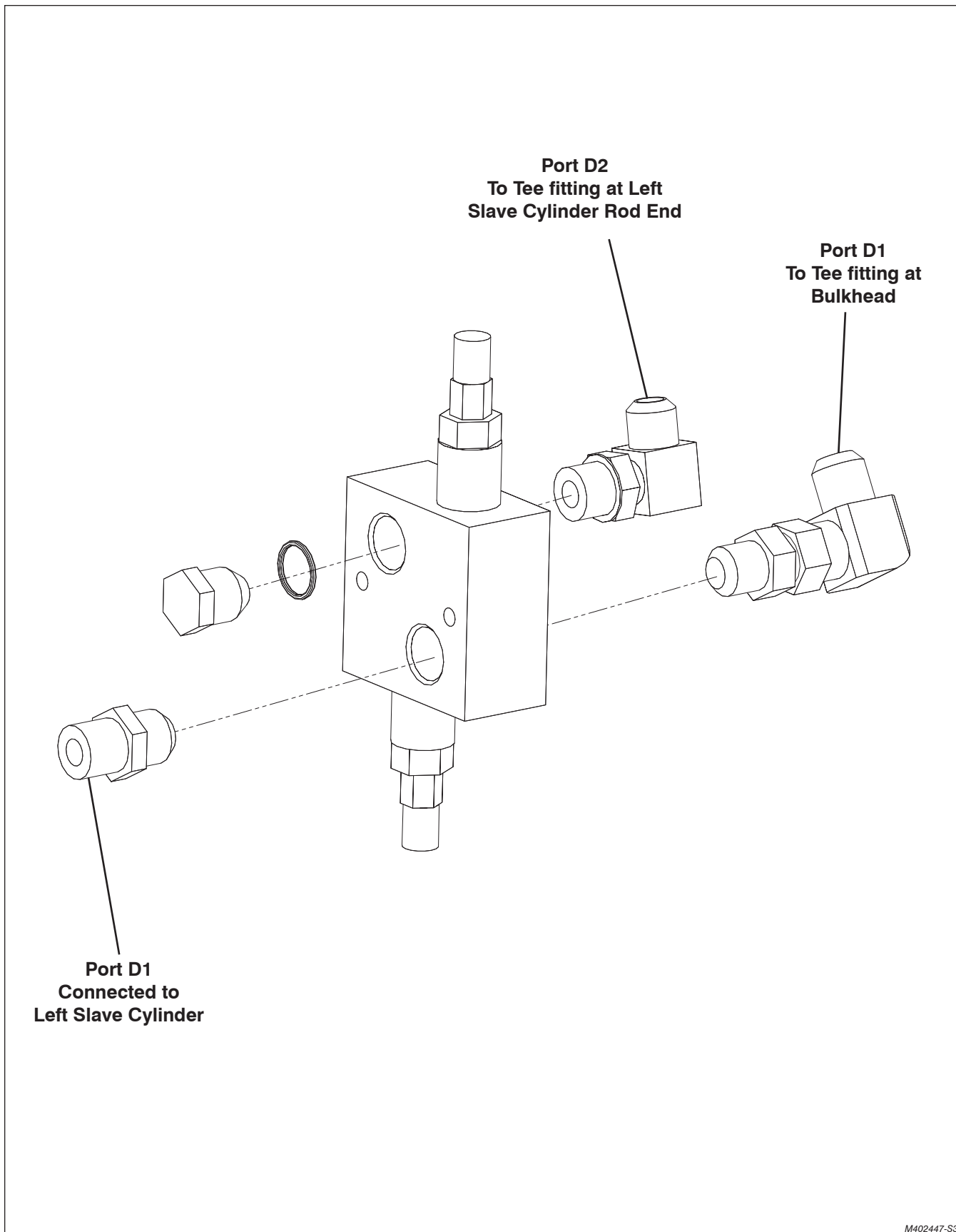

M402447-S3

3.13 Dual Charge Brake Pedal and Port Identifications

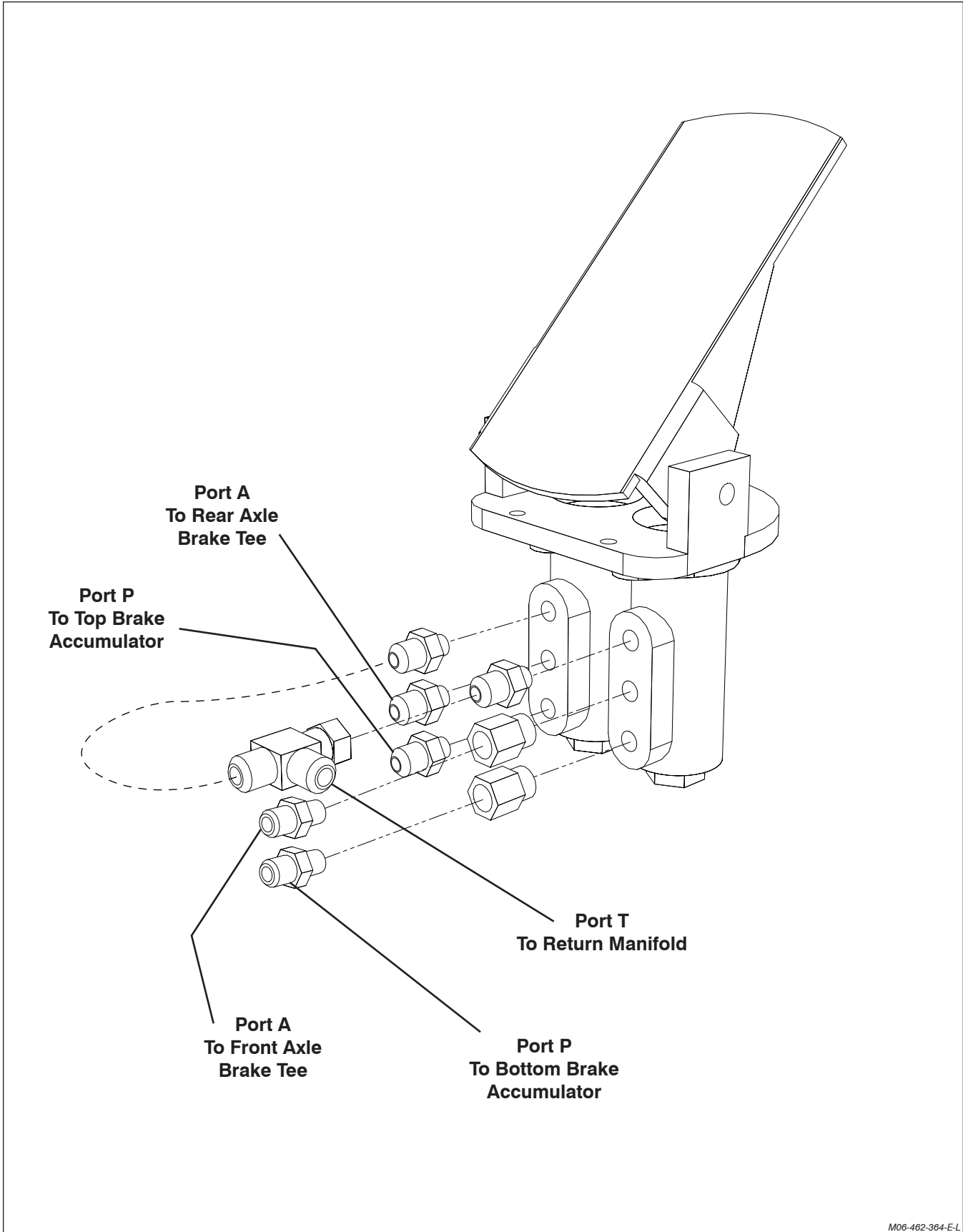

M06-462-364-E-L

3.14 Orbital Steering Motor and Port Identifications

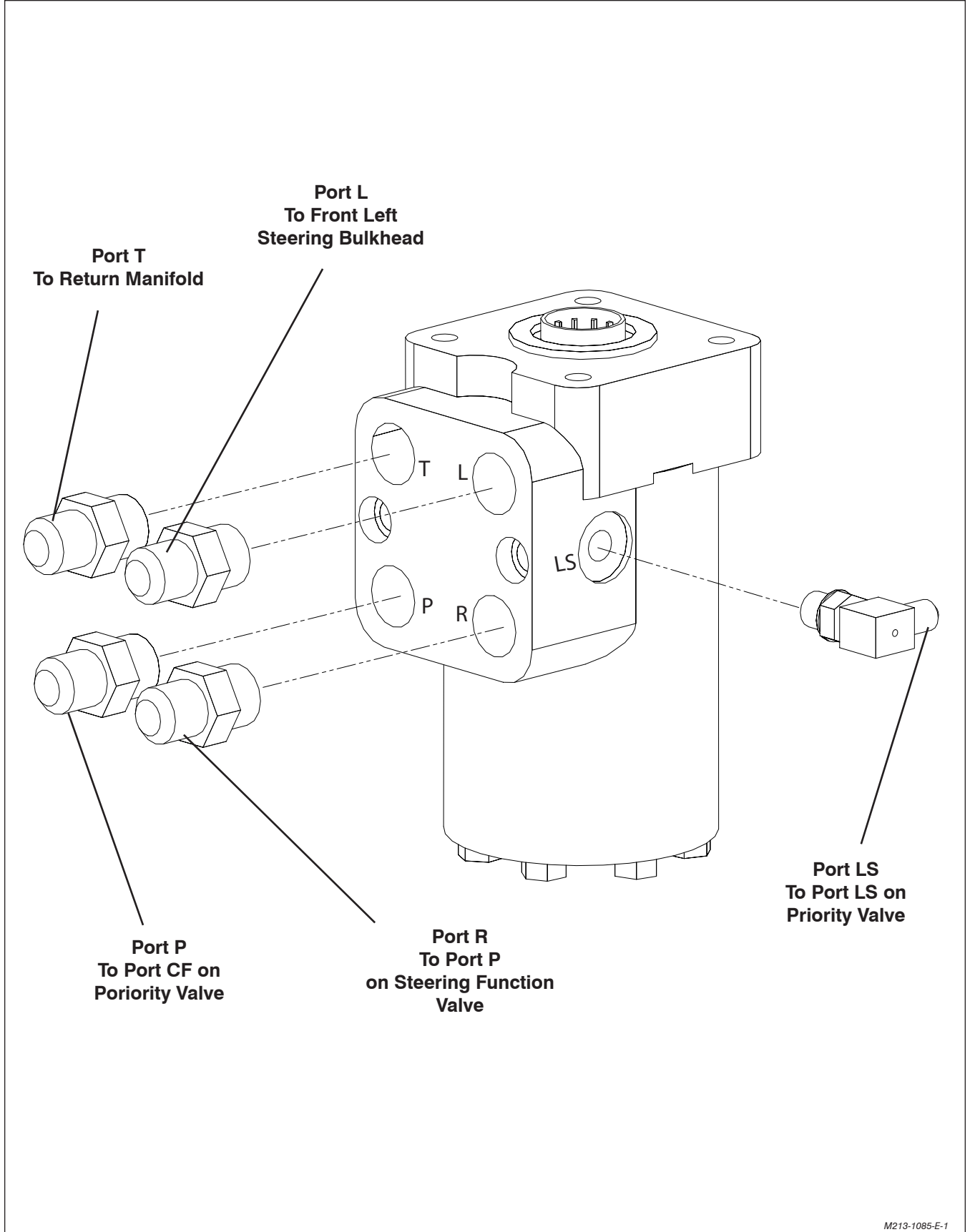

M213-1085-E-1

Notes

Blank lined area for taking notes, consisting of approximately 25 horizontal lines.

3.15a Main Valve and Main Ports Identifications

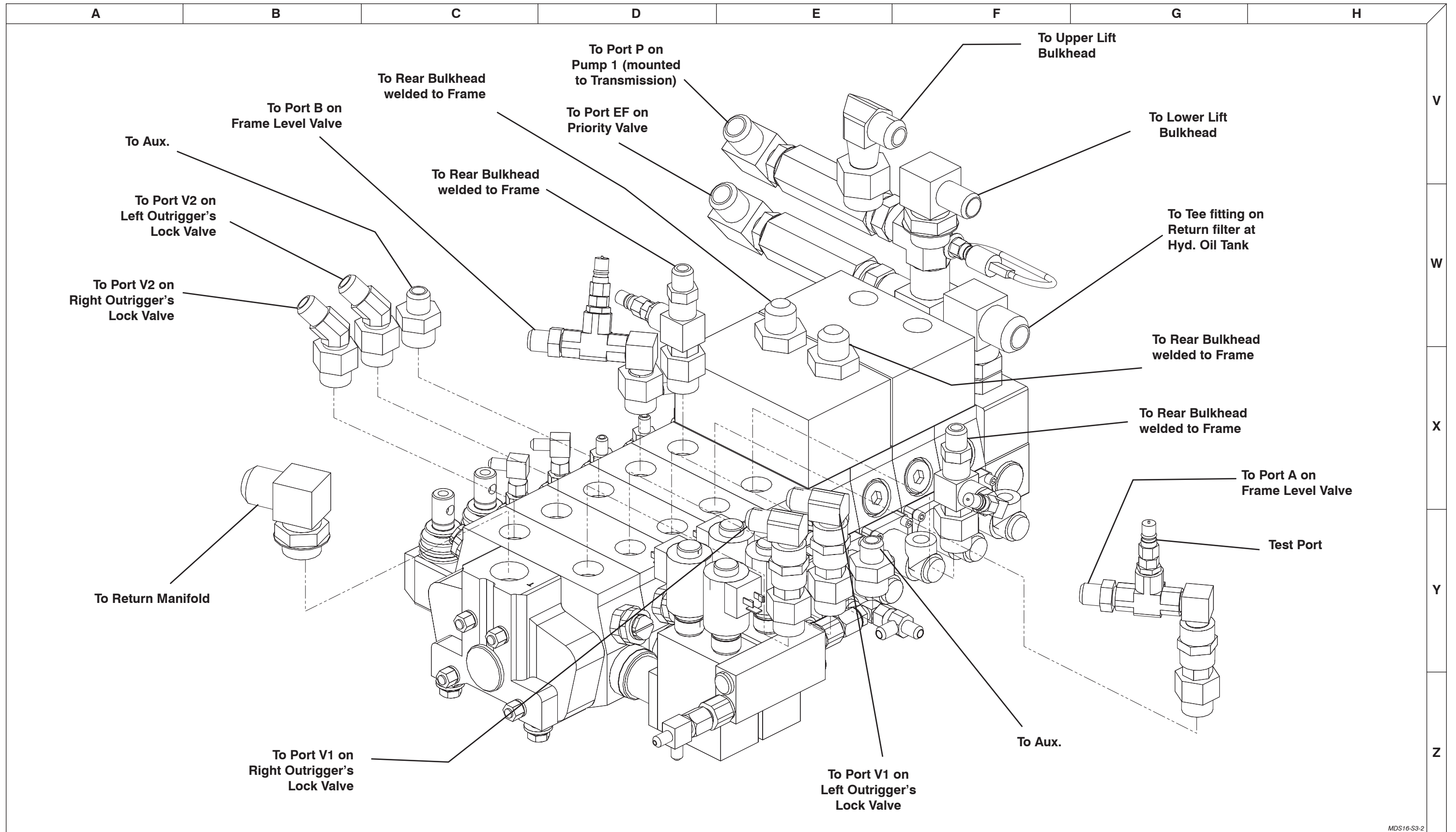

3.15b Main Valve and Pilot Ports Identifications

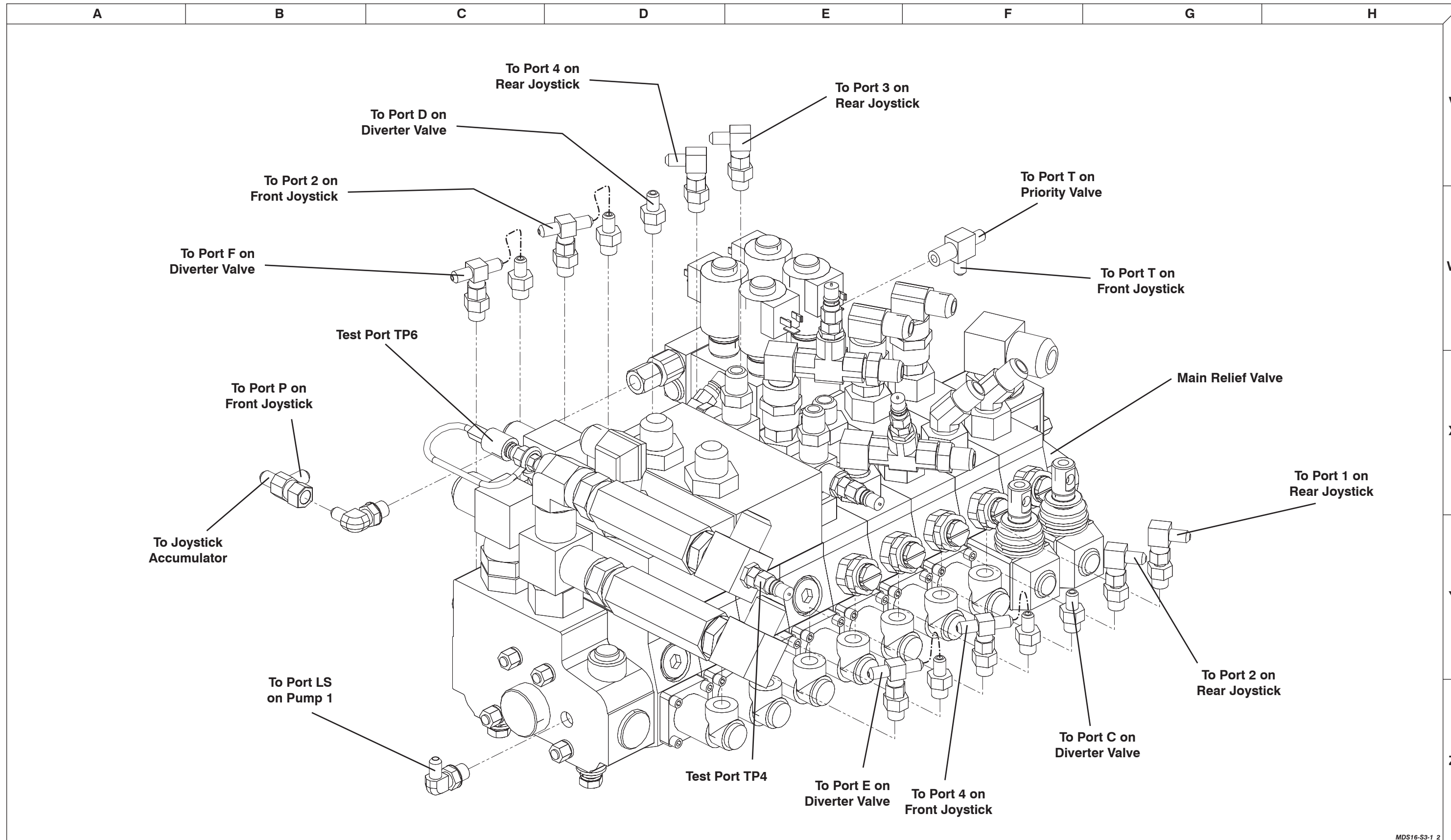

MDS16-S3-1_2

3.16 Hydraulic Cylinders Identification

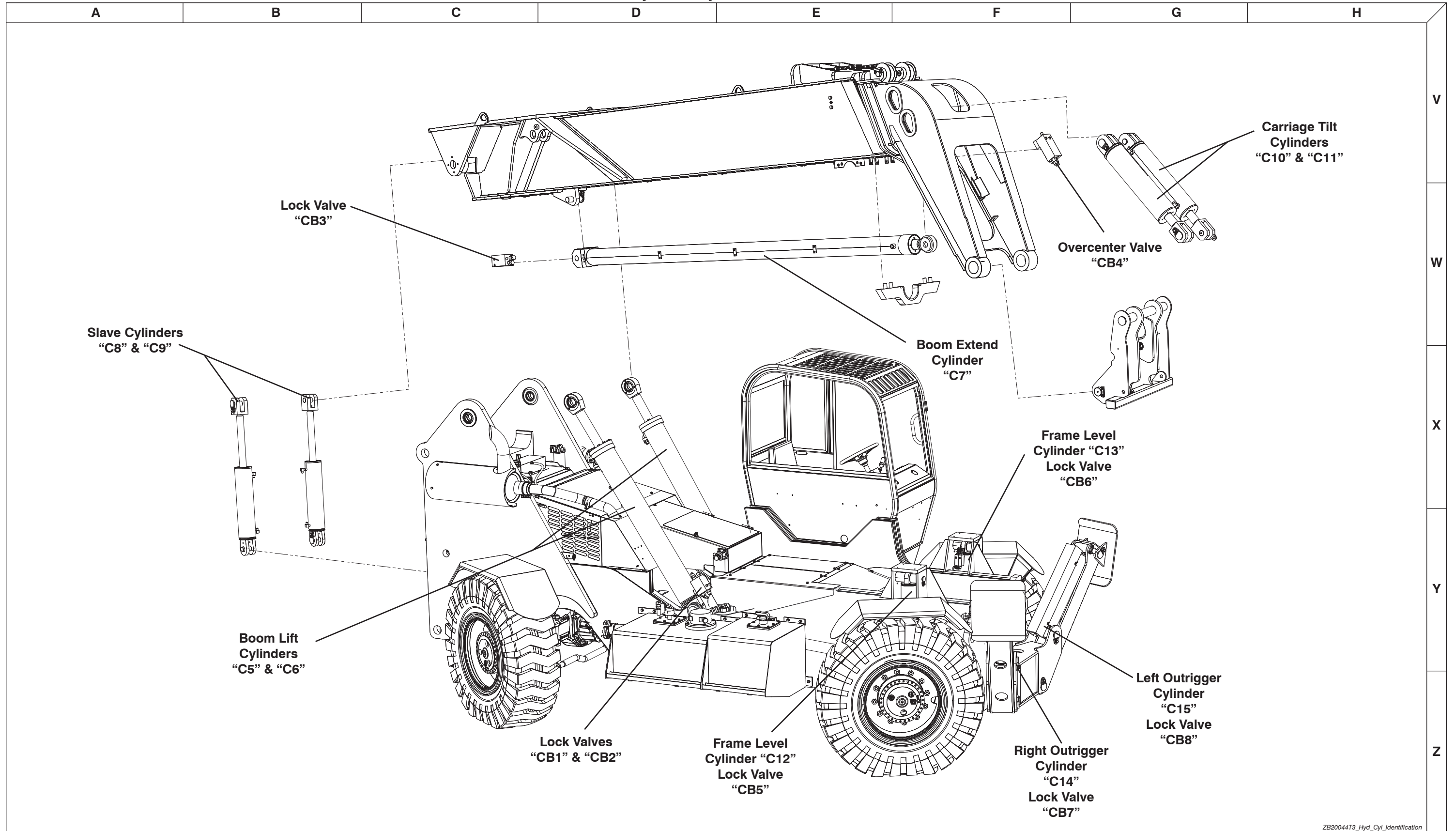

ZB20044T3_Hyd_Cyl_Identification

3.17 Hydraulic Manifolds Location

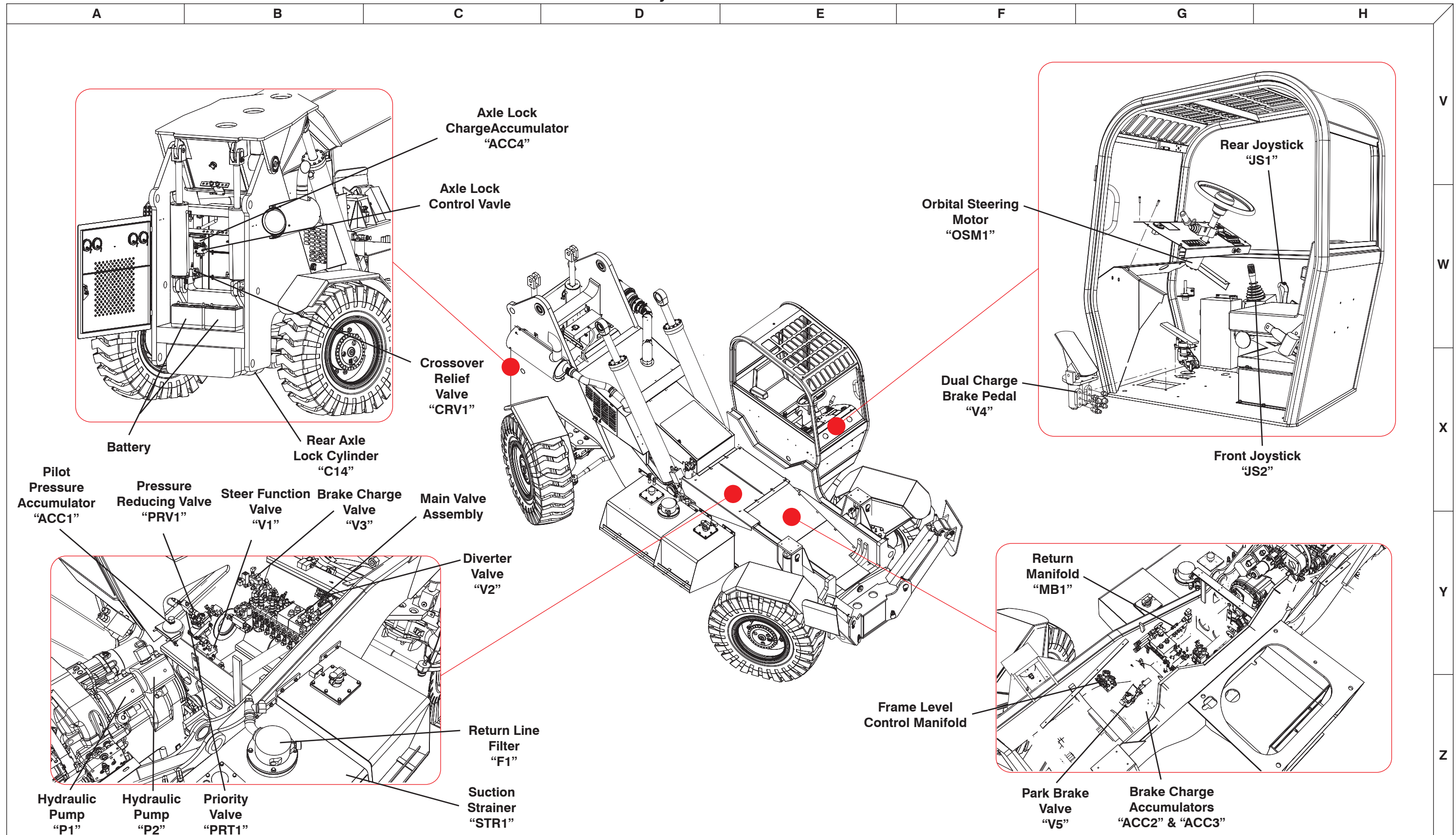

3.18a Instrument Panel Wiring Diagram (Base Model) - Part 1 of 2

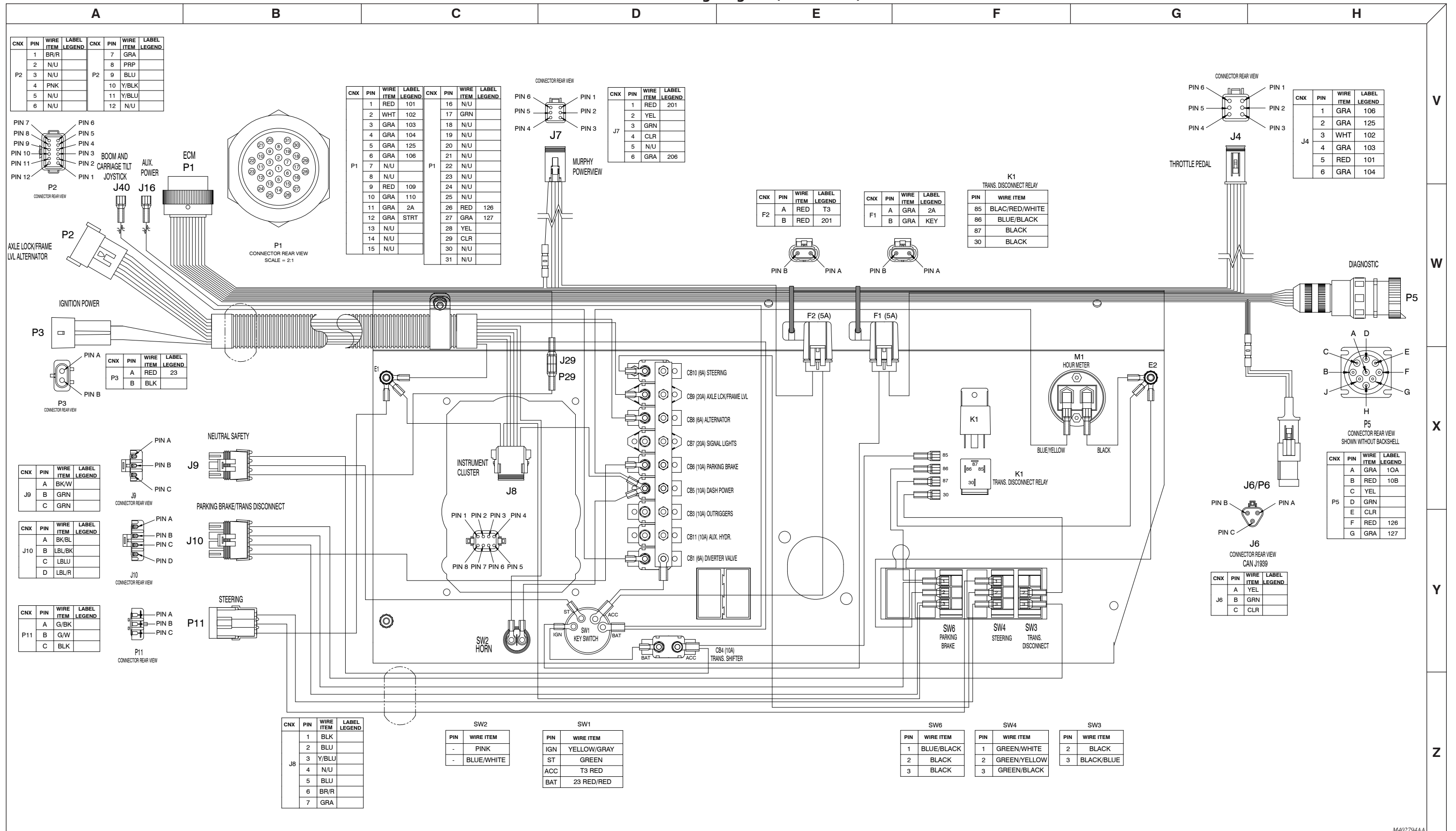

3.18b Instrument Panel Wiring Diagram (Base Model) - Part 2 of 2

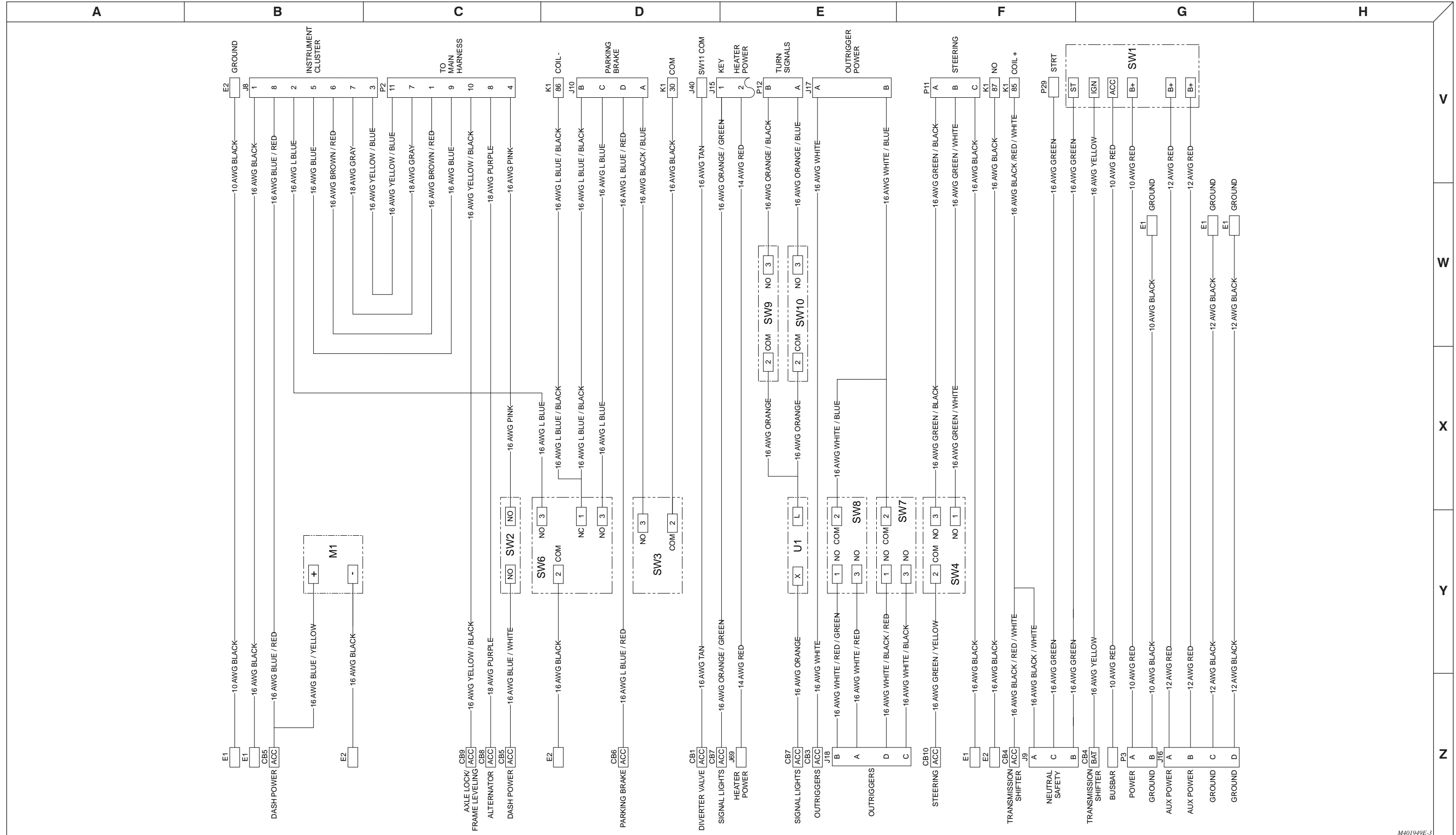

M401949E-3

3.19 Main Wiring Harness

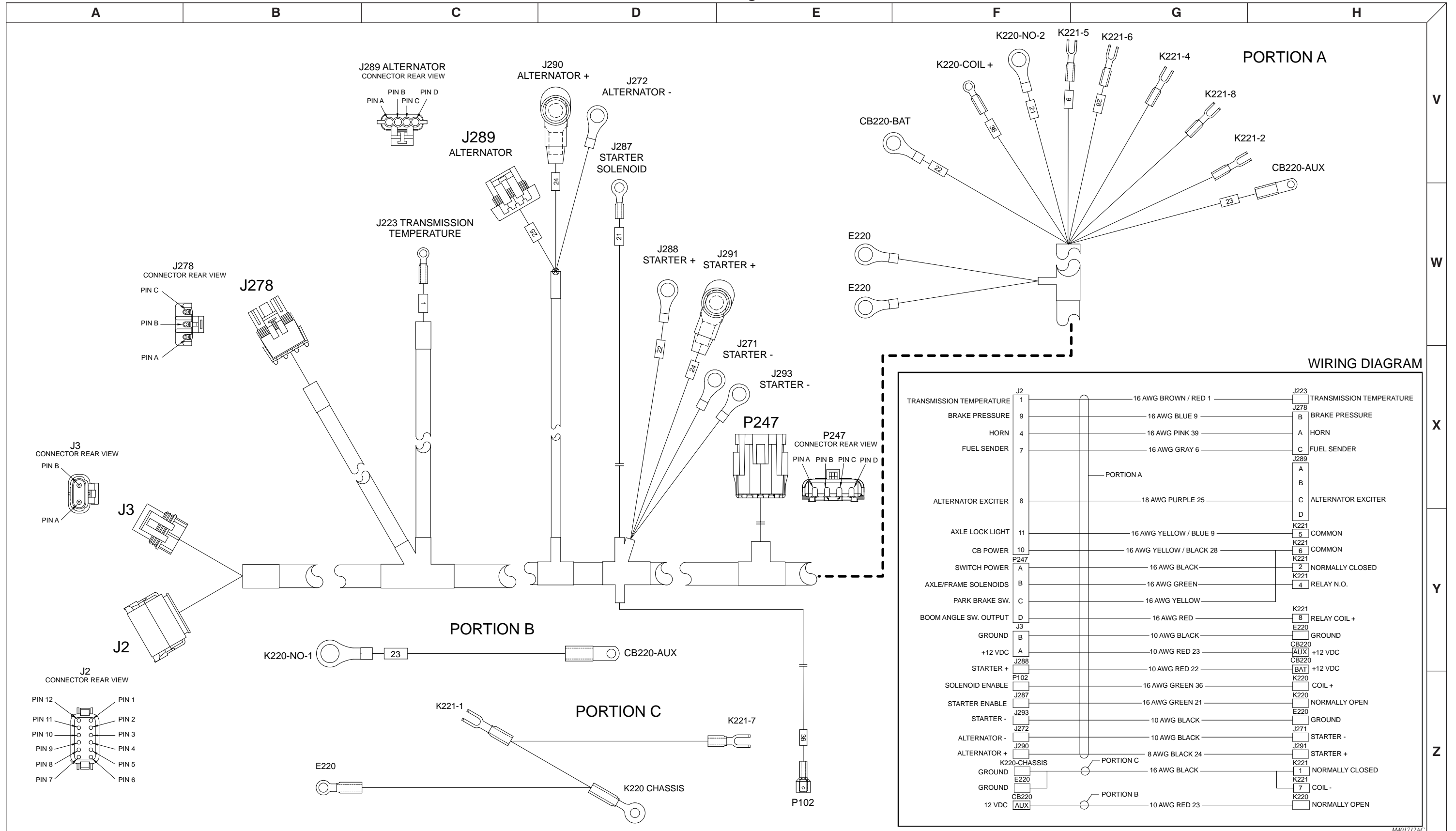

3.20 Engine Harness (QSB4.5 Tier 3)

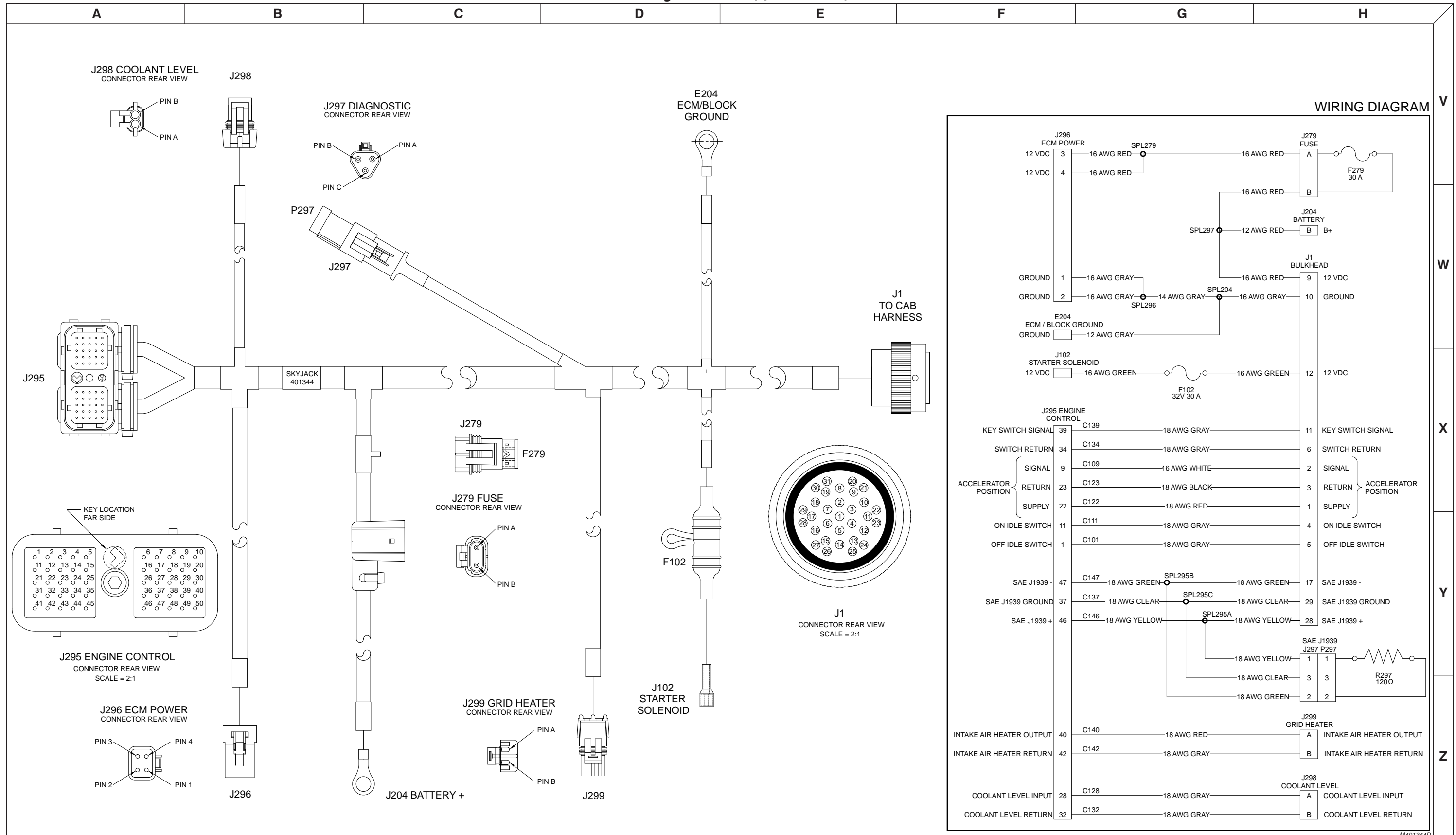

3.21 Transmission T32000 Harness

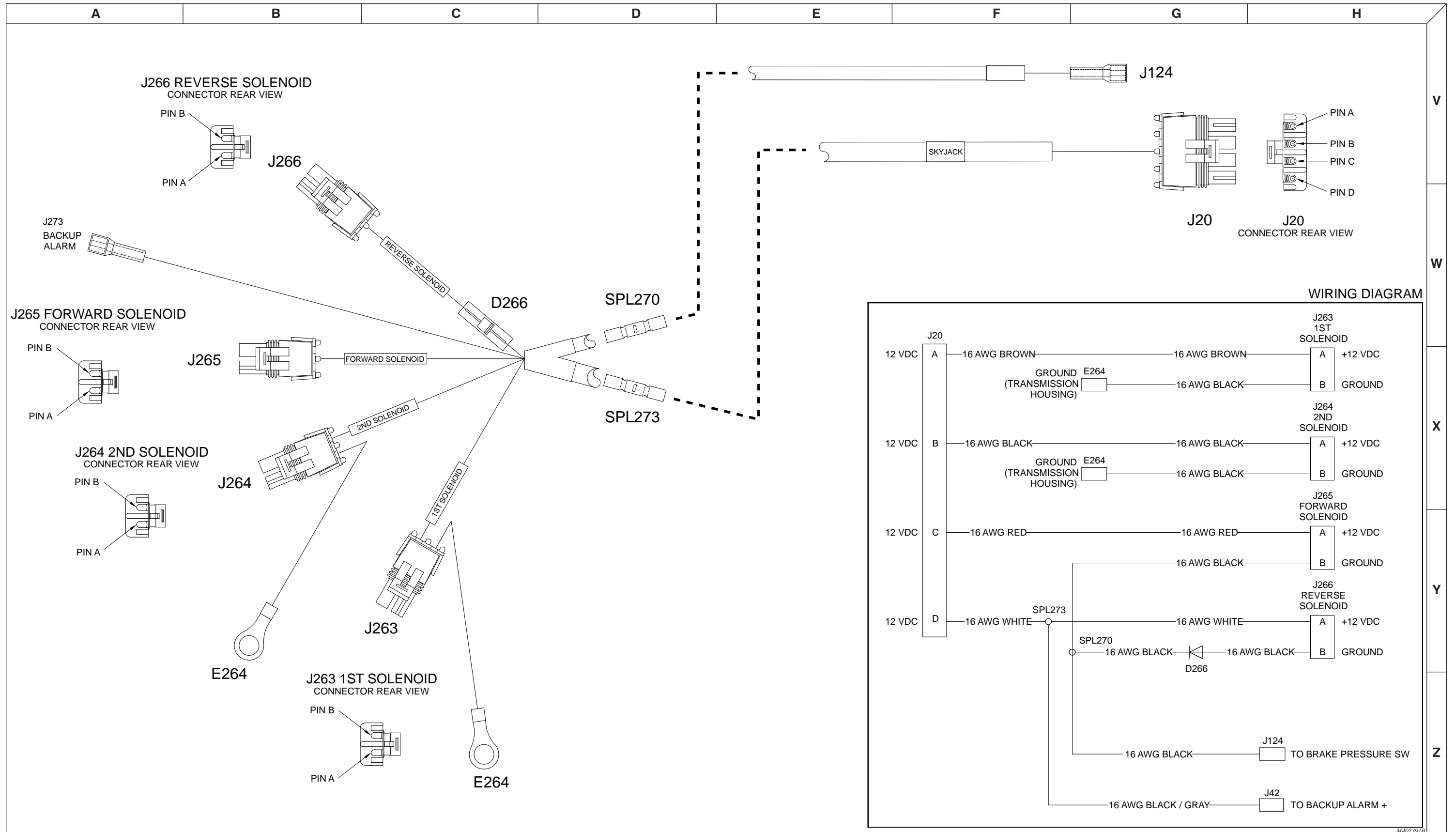

3.22 Frame Level Harness

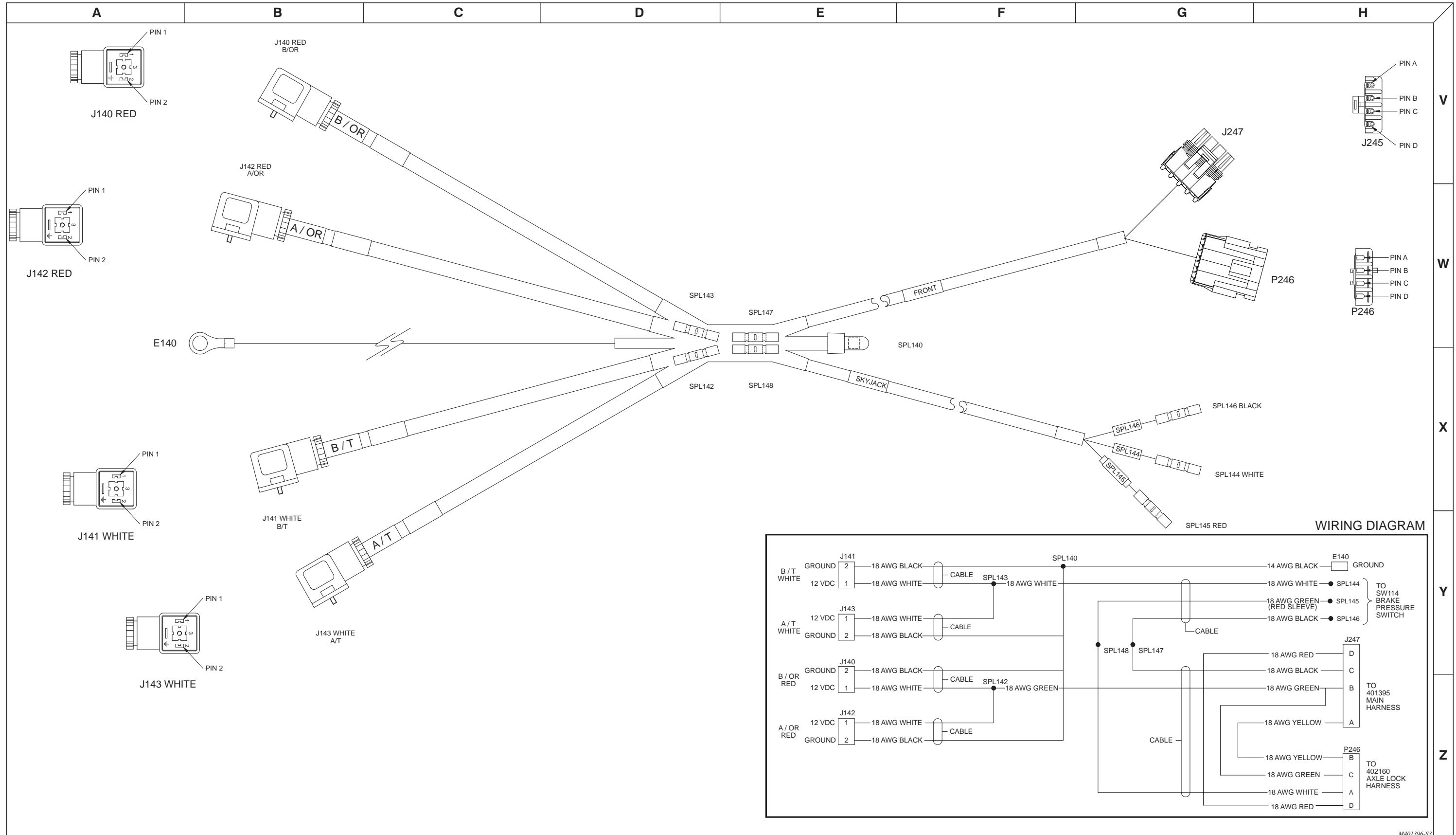

3.23 Axle Lock Harness

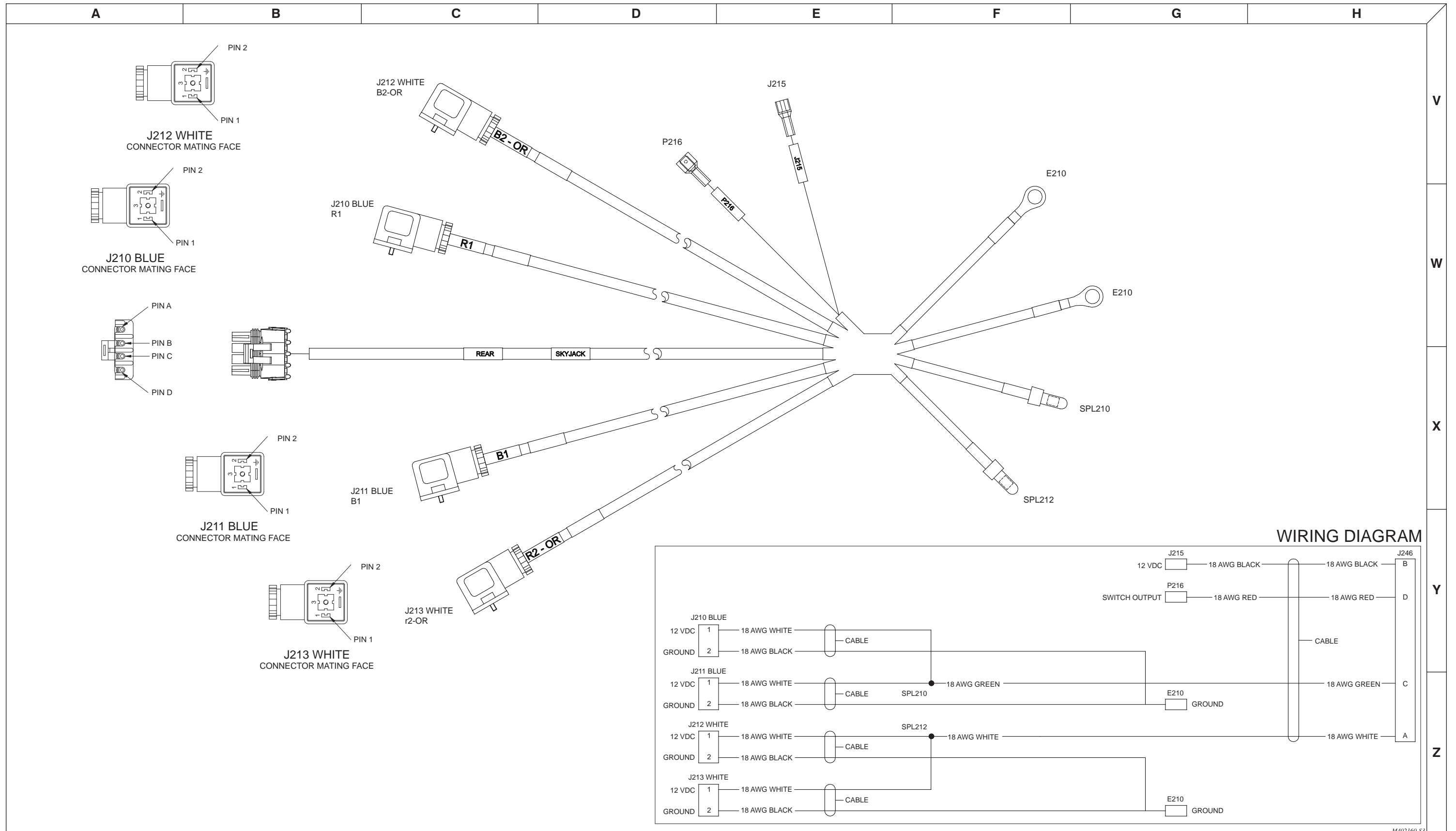

3.24 Diverter Valve Harness, 2-Way

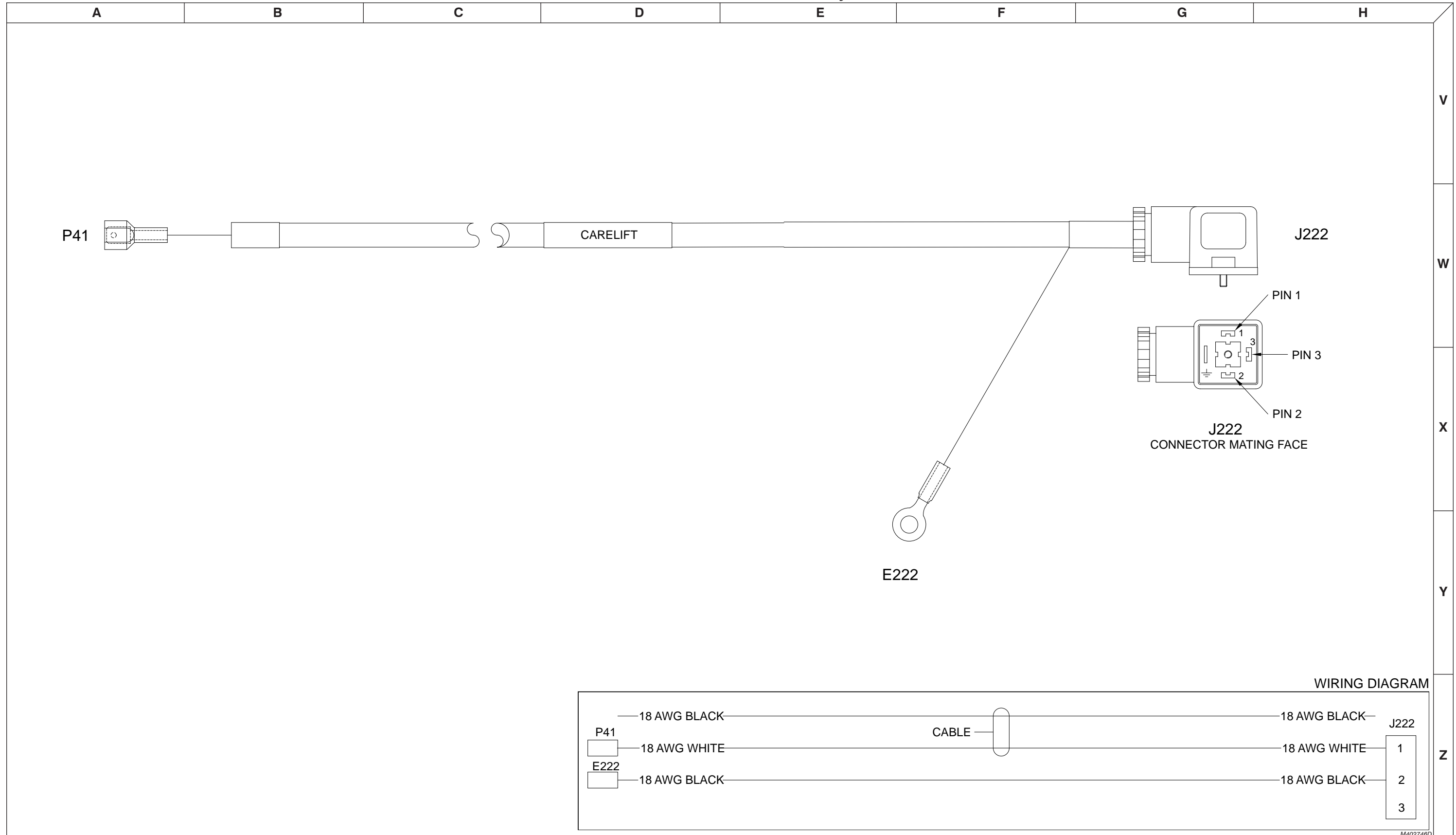

3.25 Parking Brake Harness

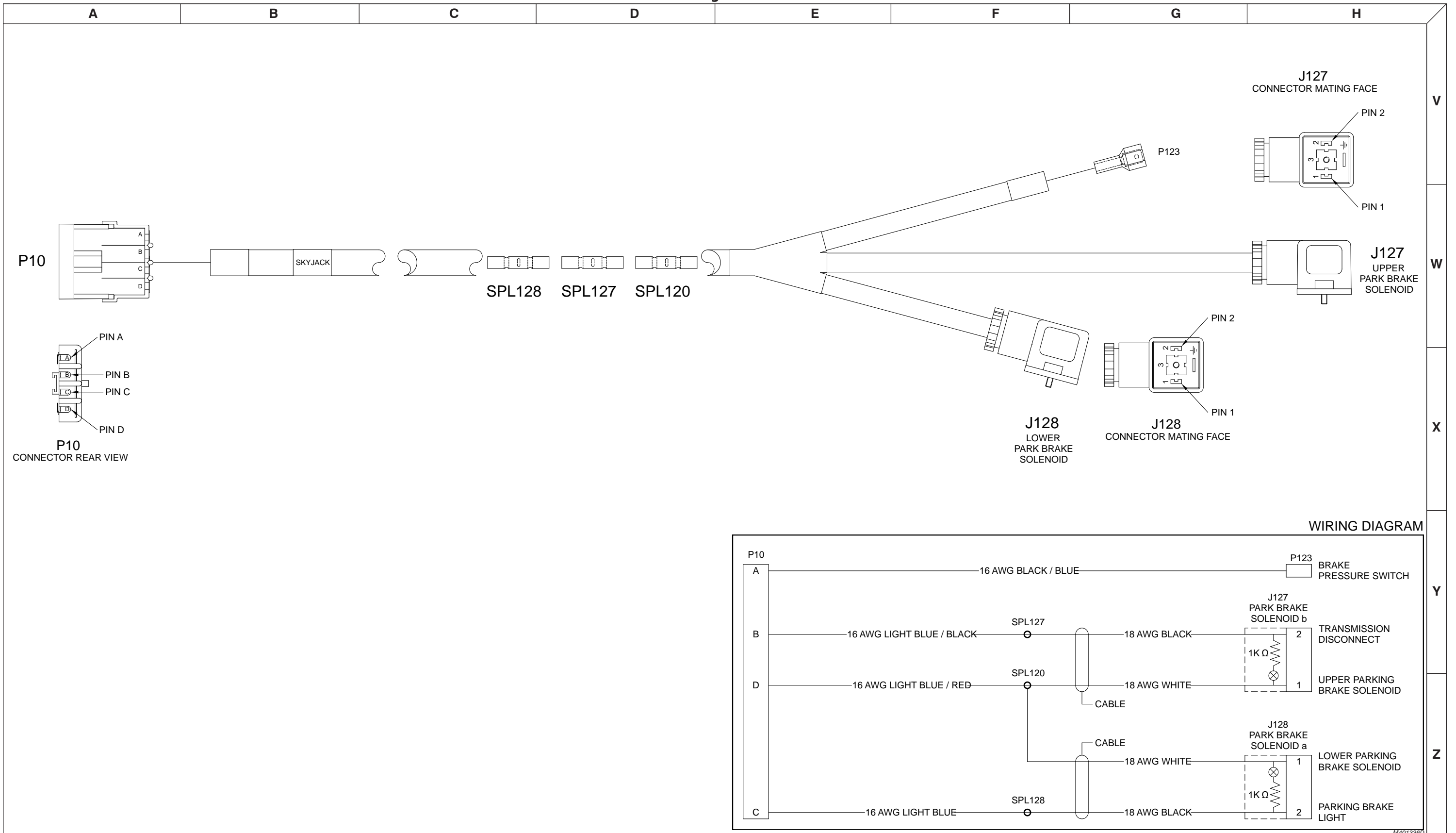

3.26 Steering Harness

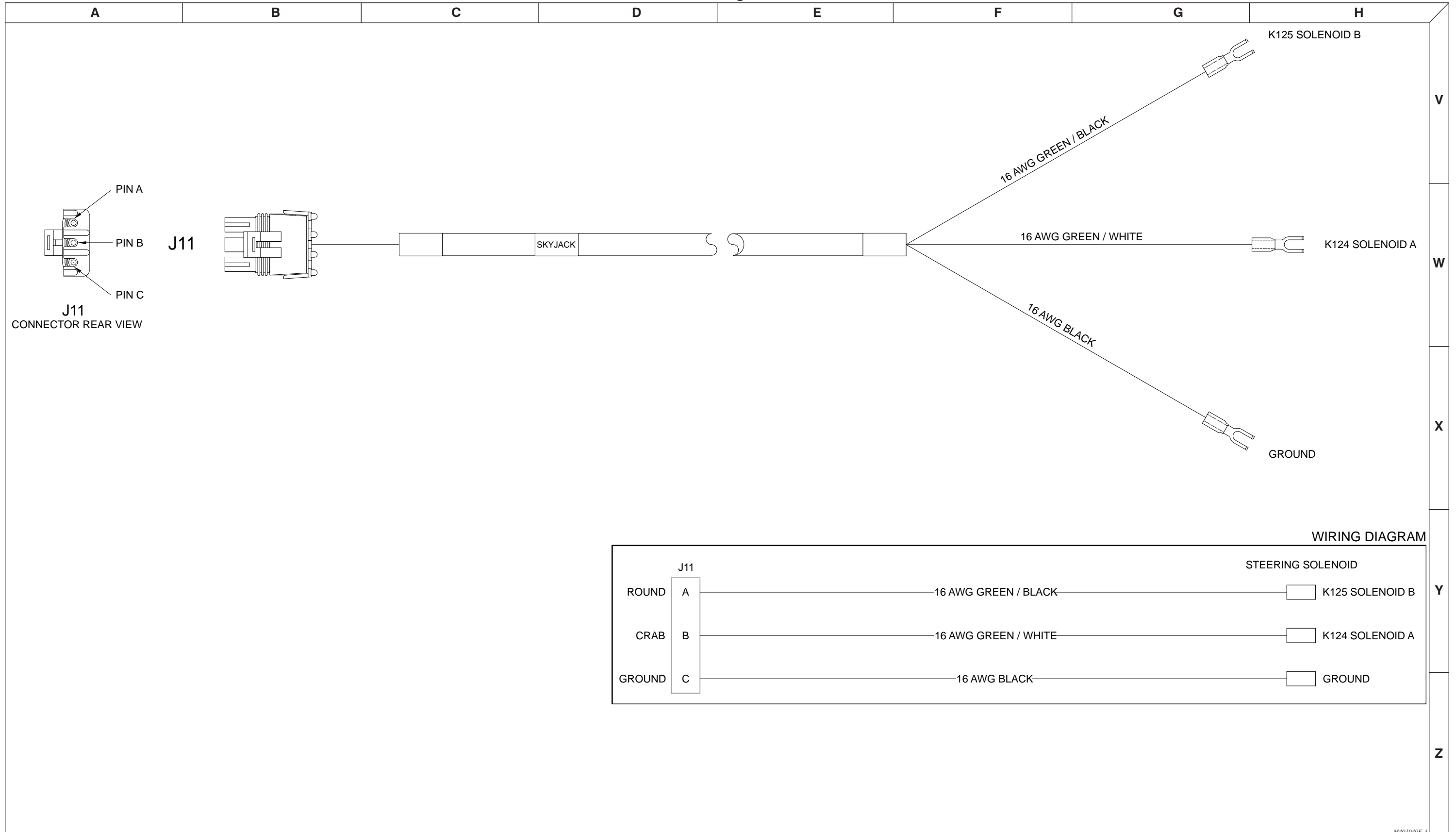

3.27 Horn, Fuel & Brake Pressure Switch Harness

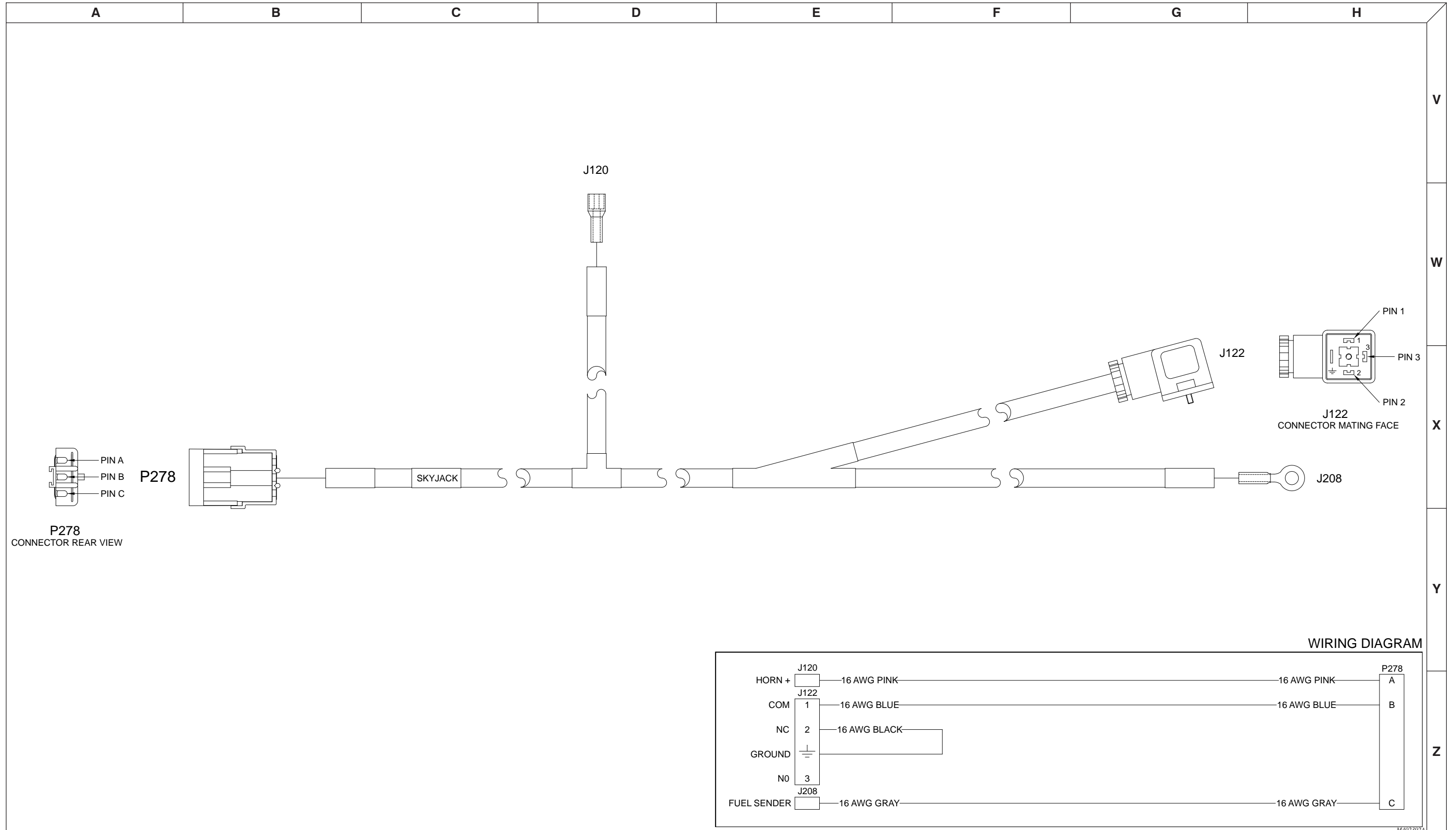

3.28 Joystick with Horizontal Rocker Switch

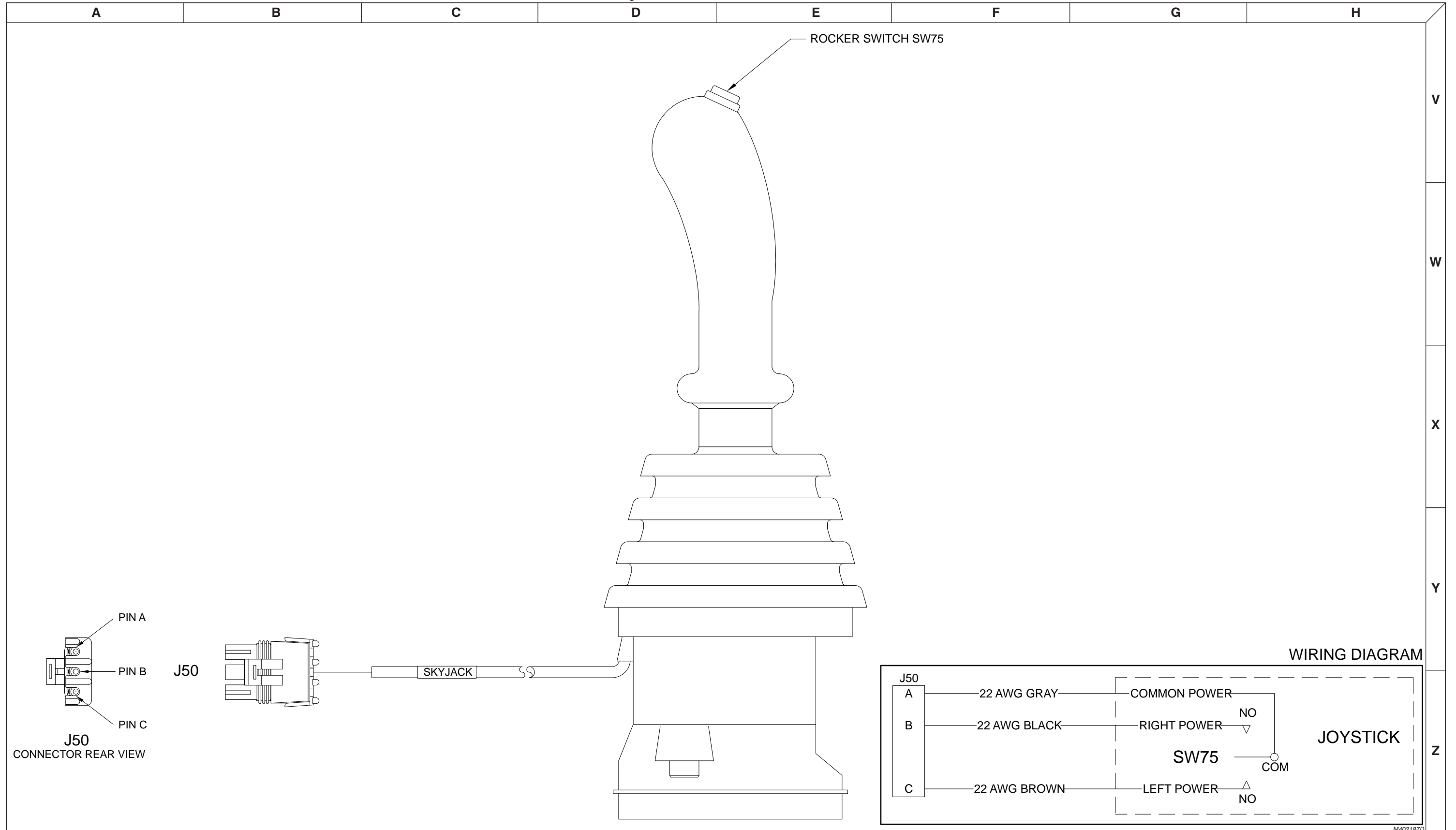

3.29 Three-Speed Shifter

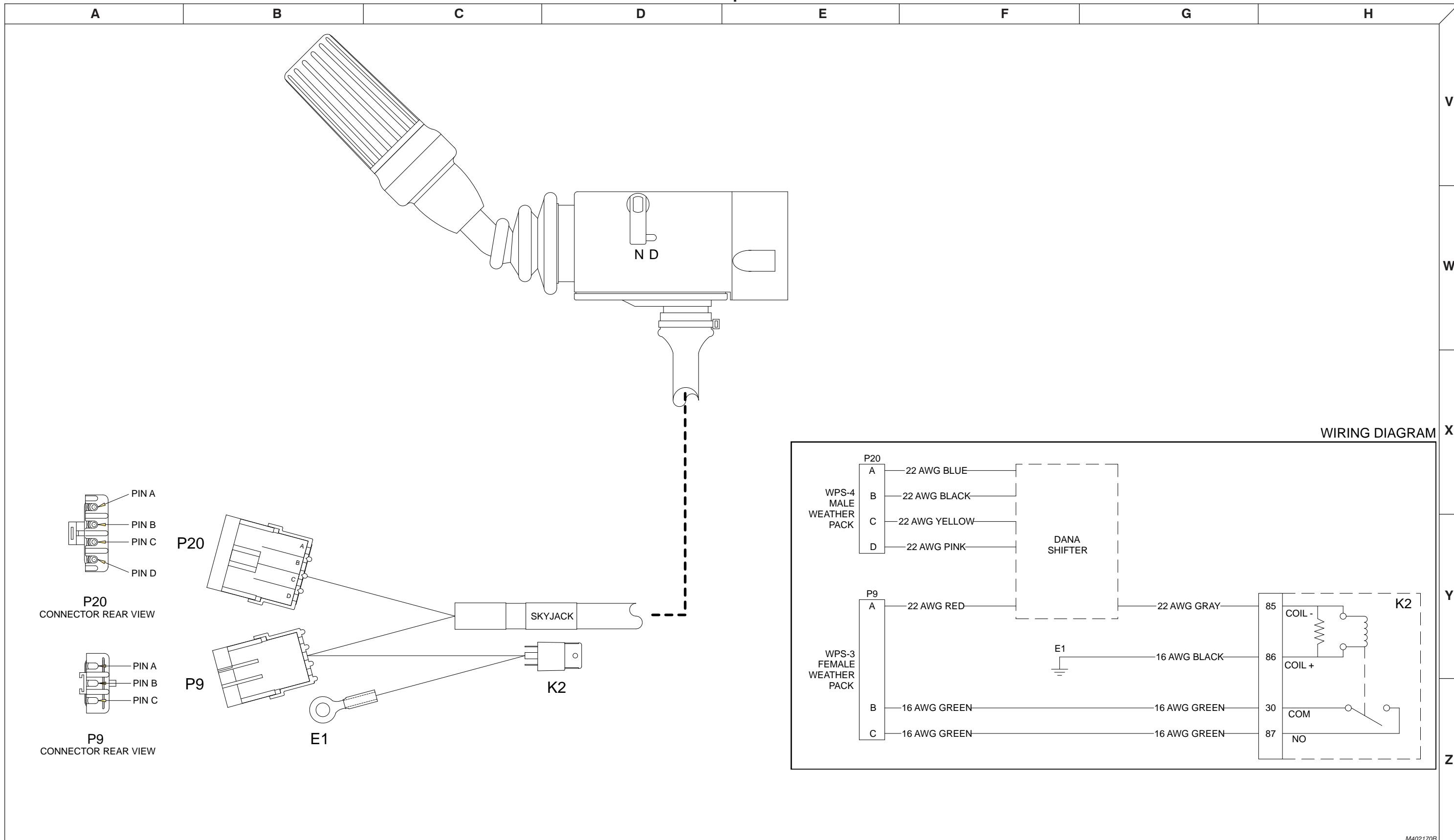

3.30 Joystick, Two-Axis with Microswitch

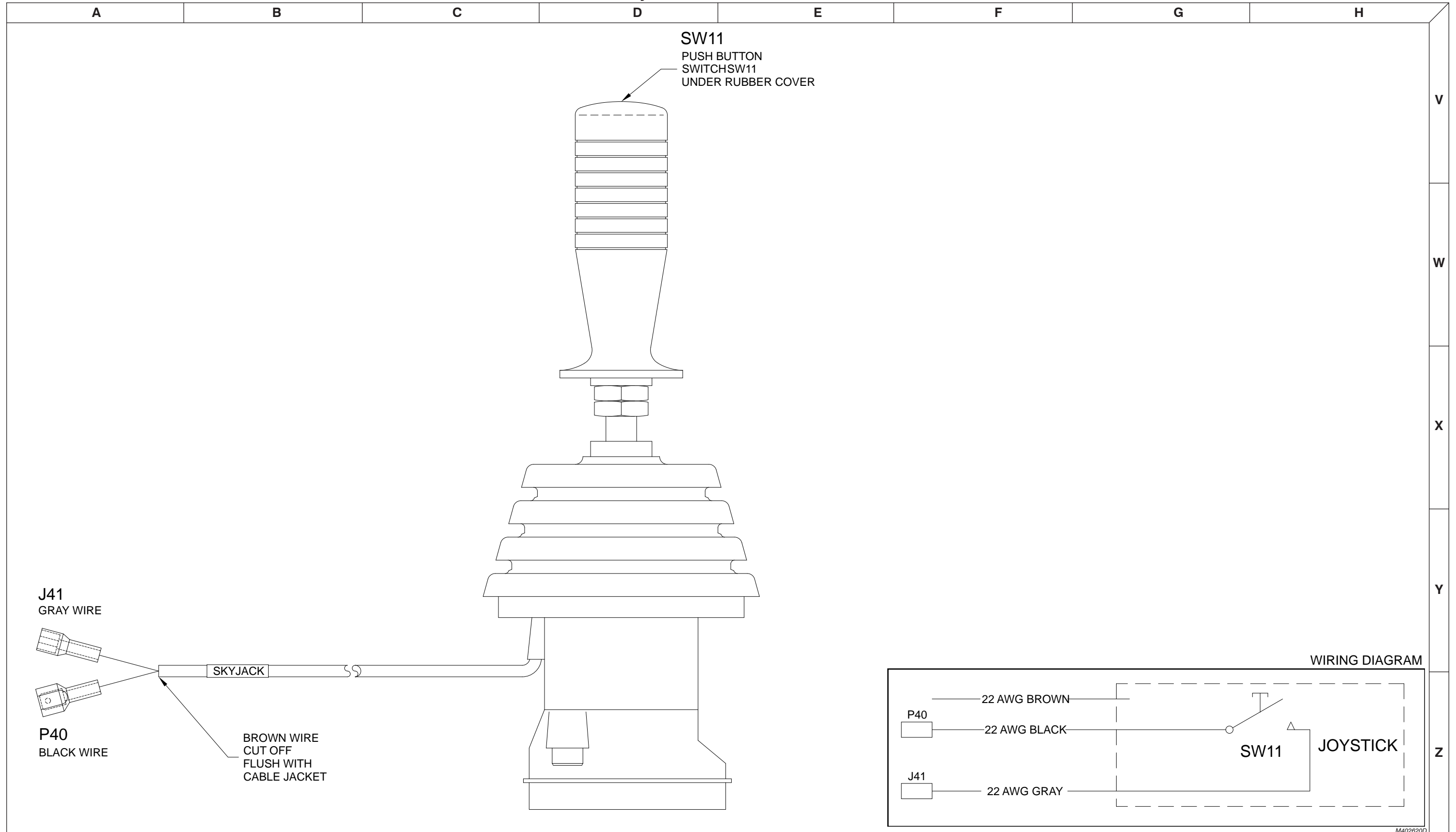

3.31 Power Module - Enclosed Cab Harnesses

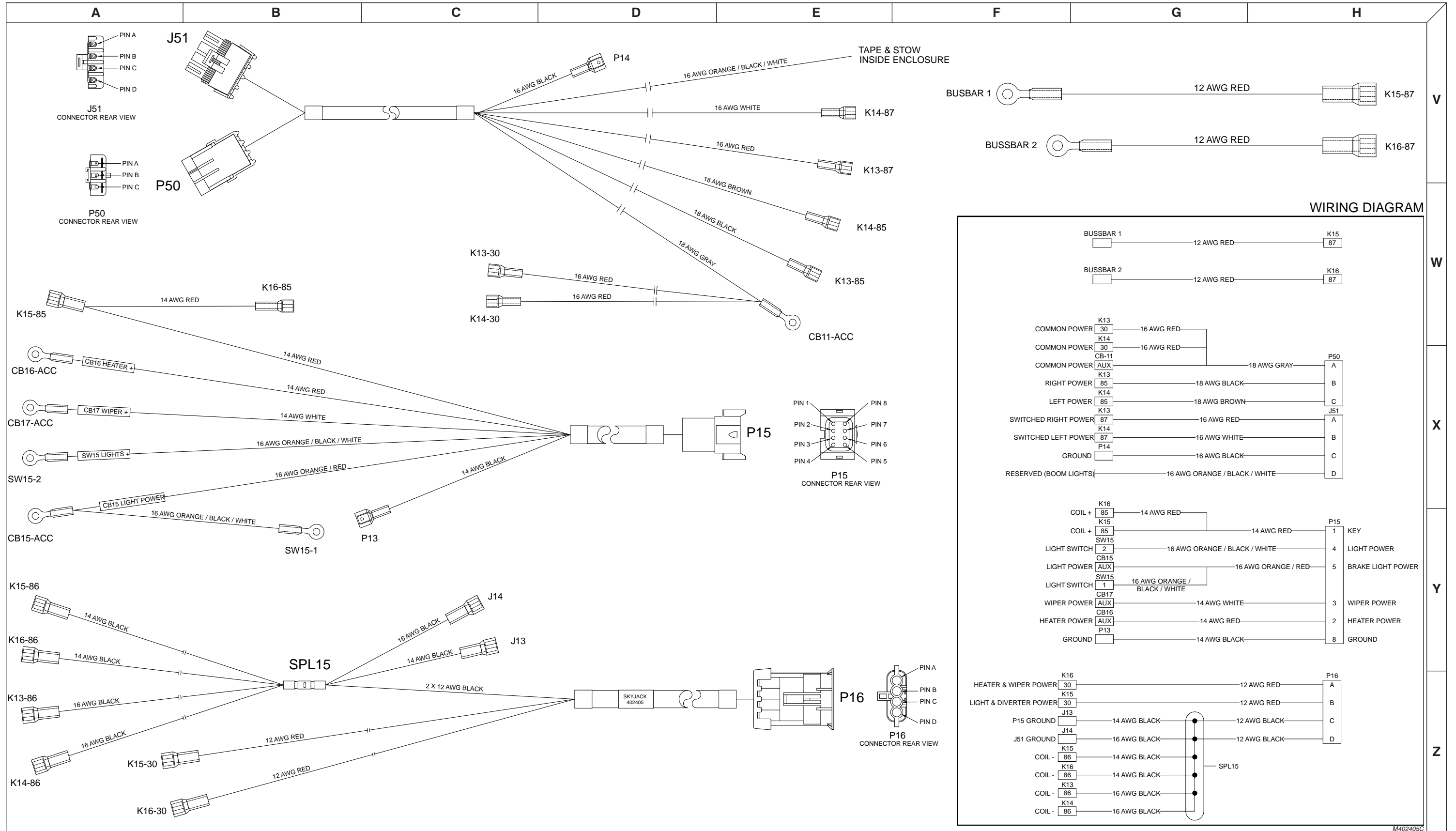

3.32 Power Module - Open Cab Harnesses

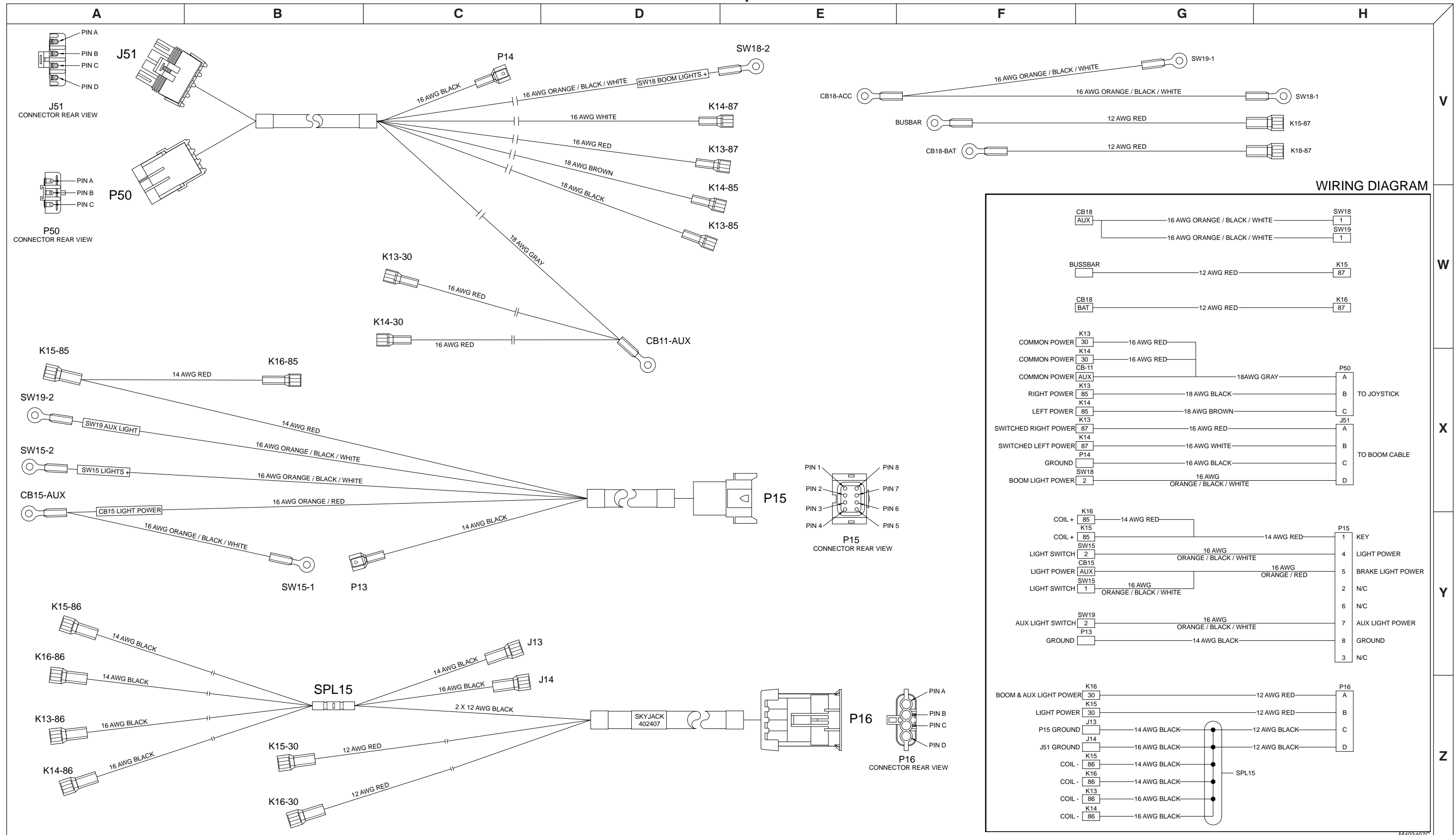

3.33 Lighting Harness

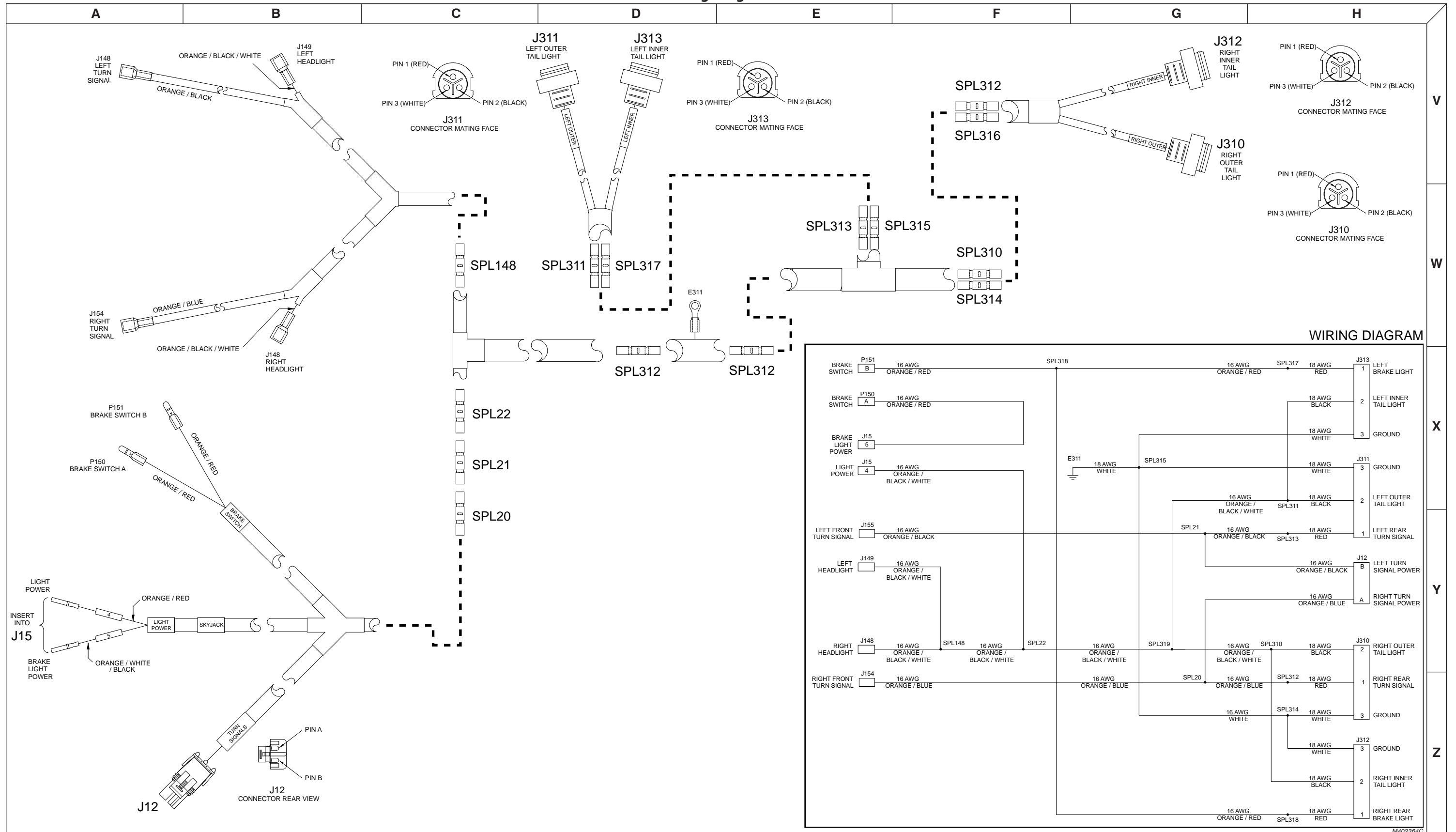

3.34 Wiper Harness

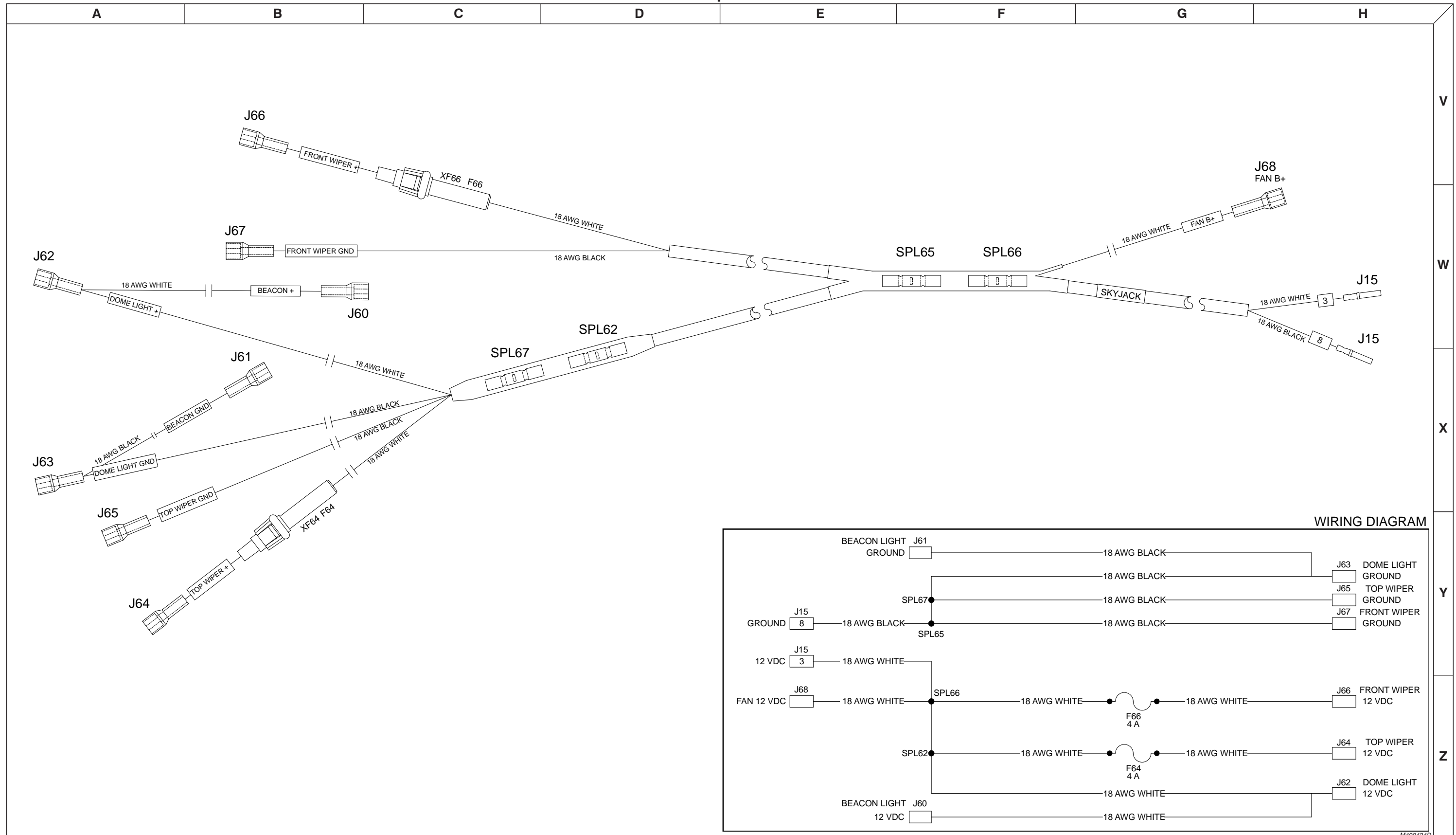

WIRING DIAGRAM

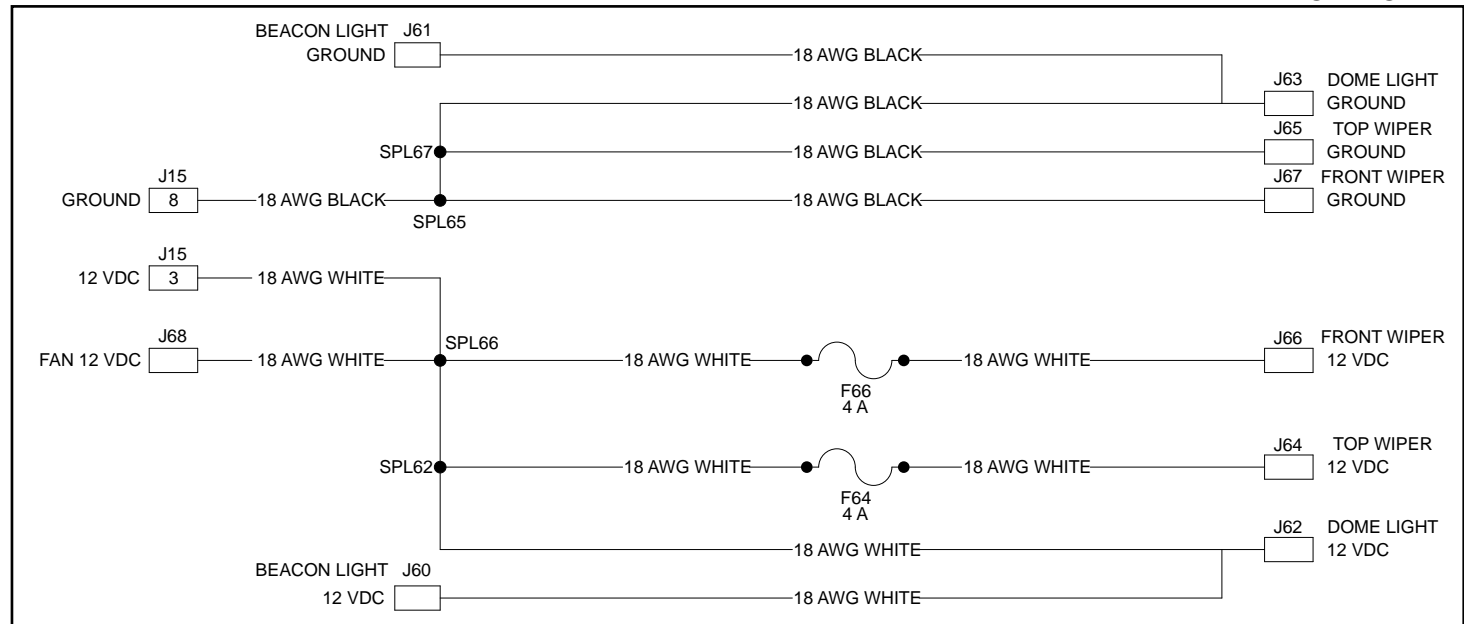

3.35 Grappler Harness

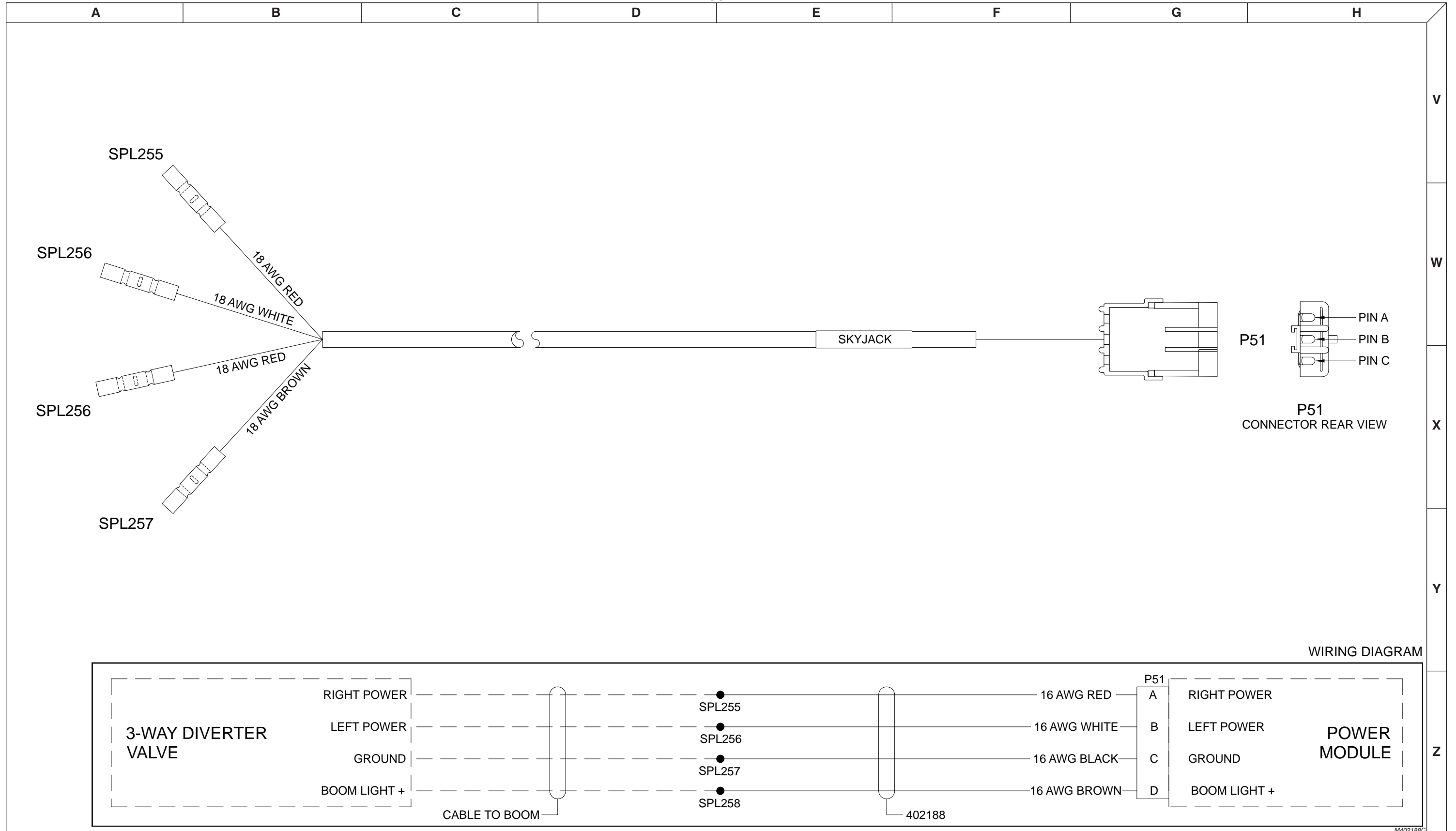

3.36 Outrigger Raise/Lower Harness

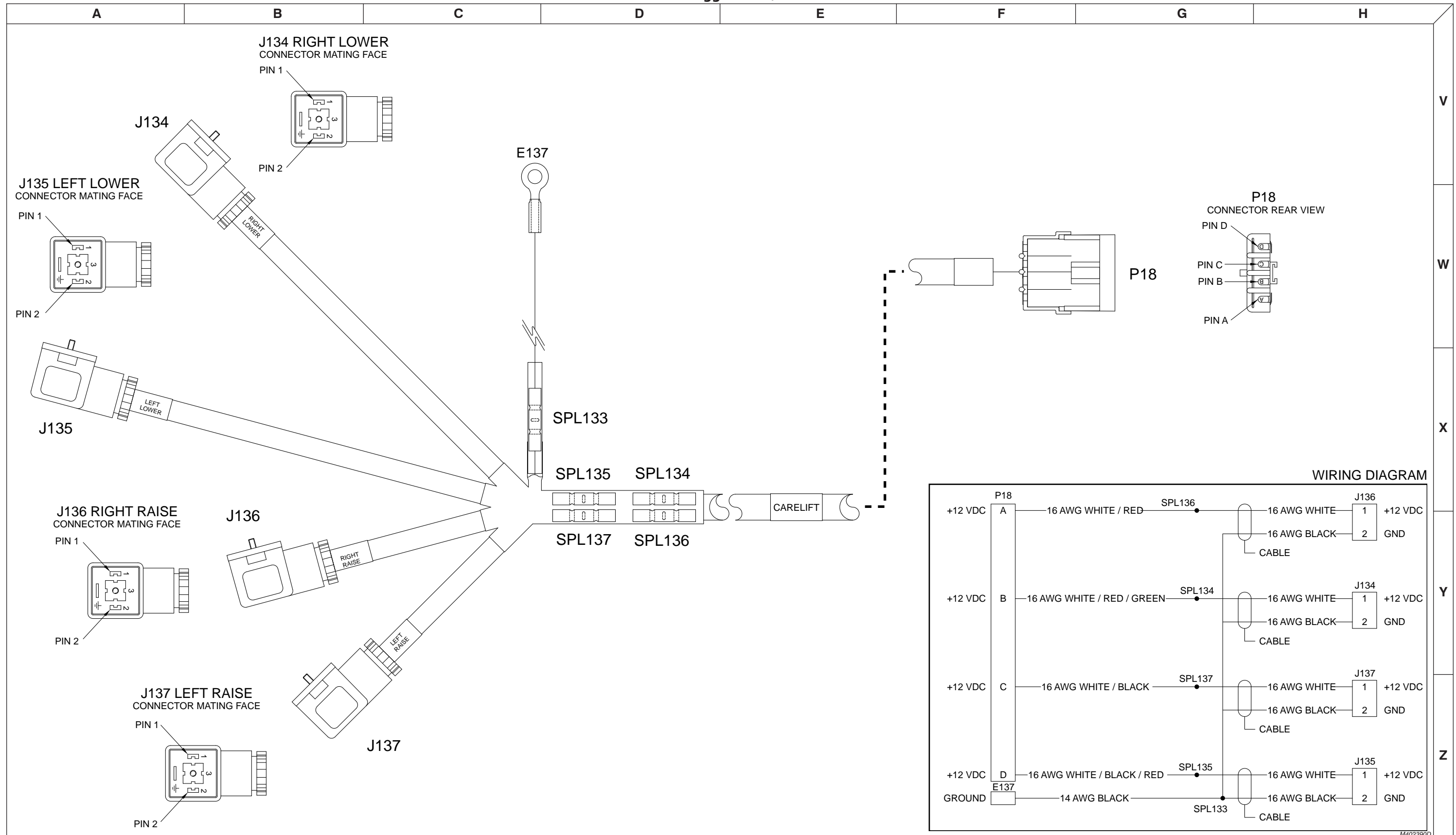

3.37 Mine Spec. - Brakes Harness

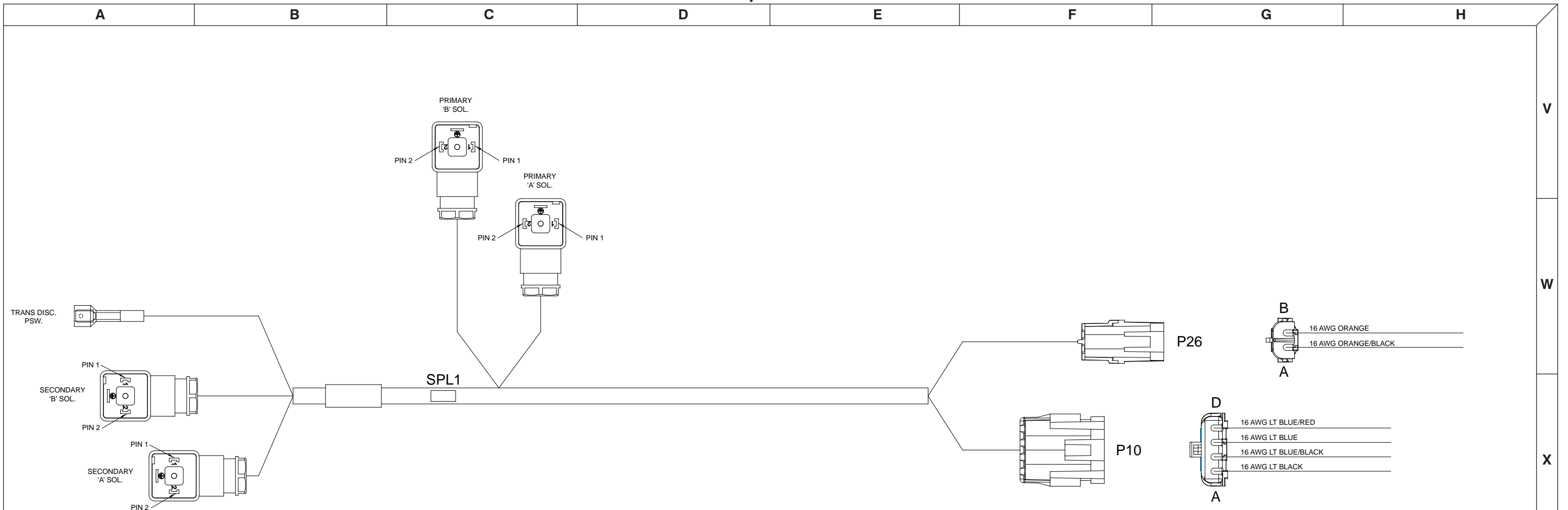

WIRING DIAGRAM

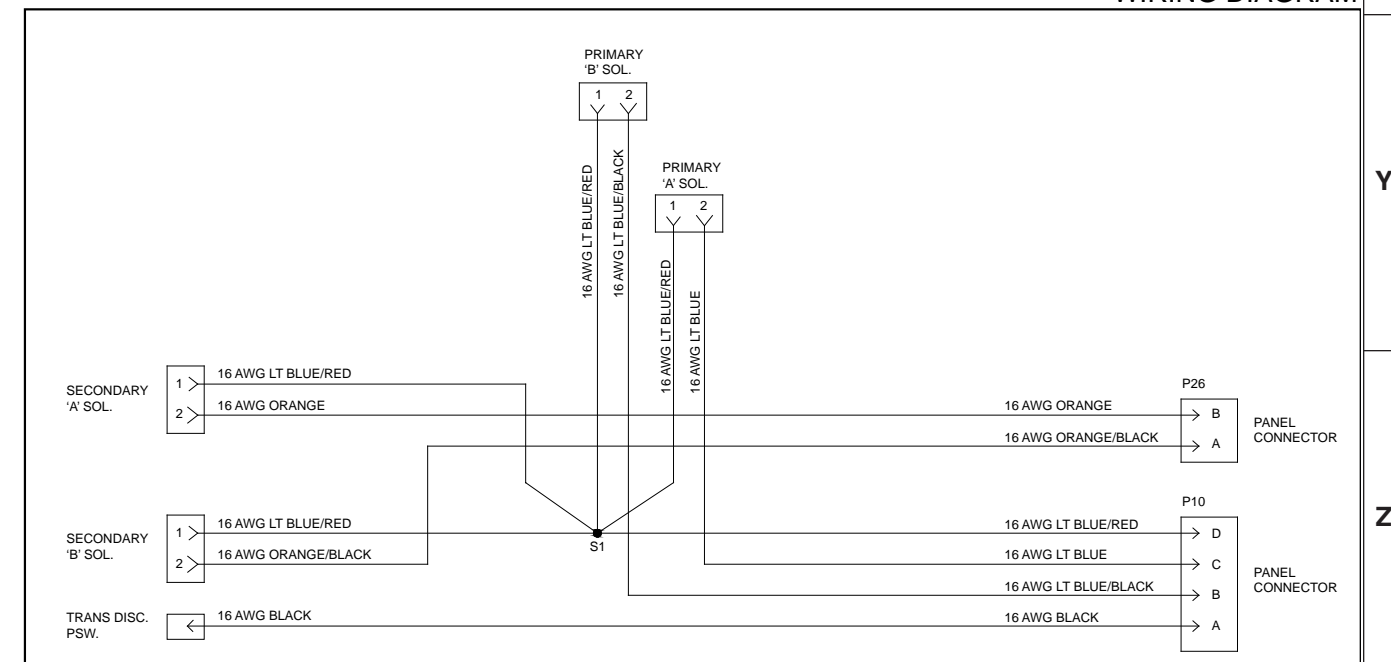

M156735 - SERVICE

3.38 Mine Spec. - Pressure Switches Harness

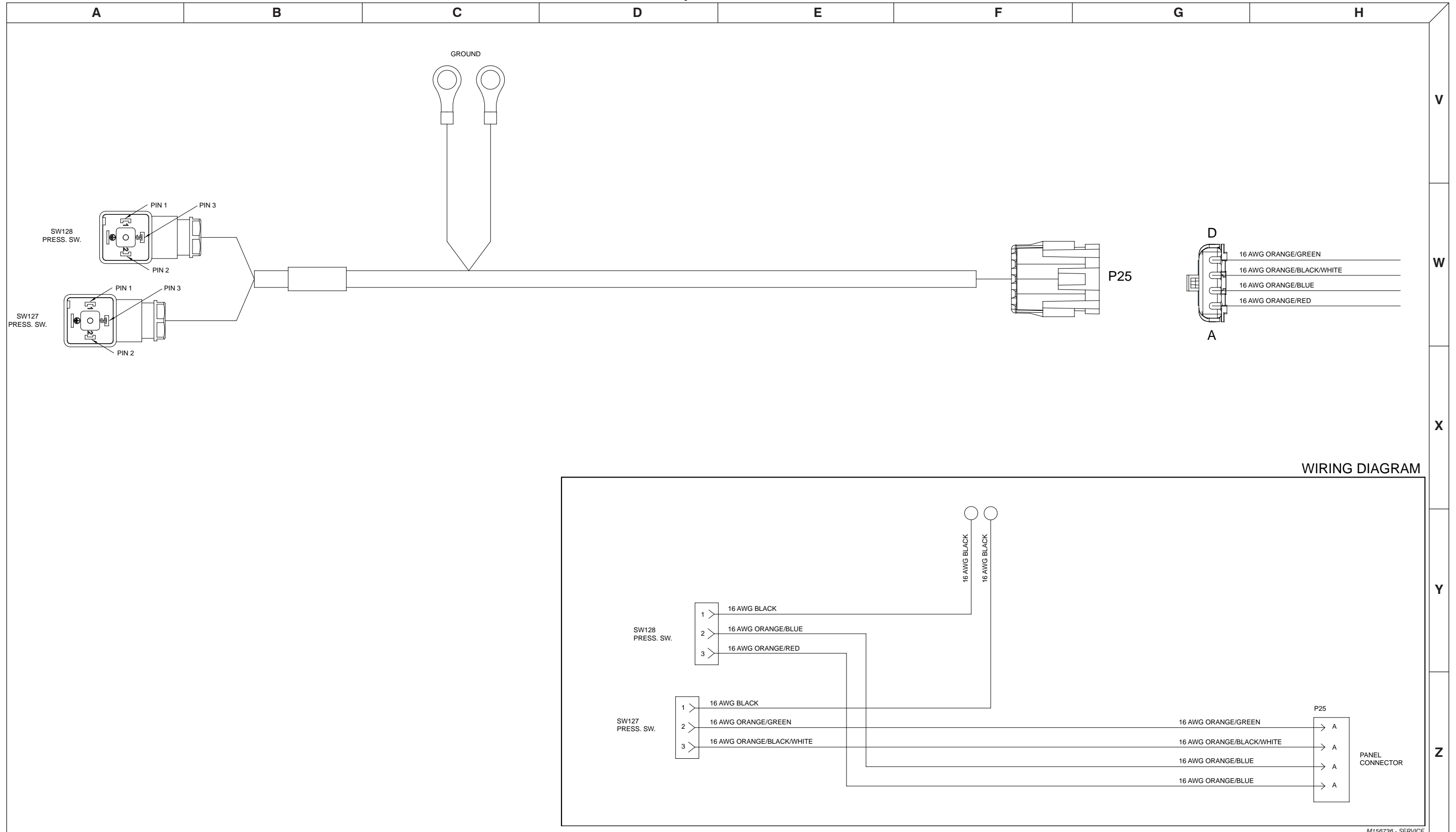

3.39 Mine Spec. - Steering Accumulator Harness

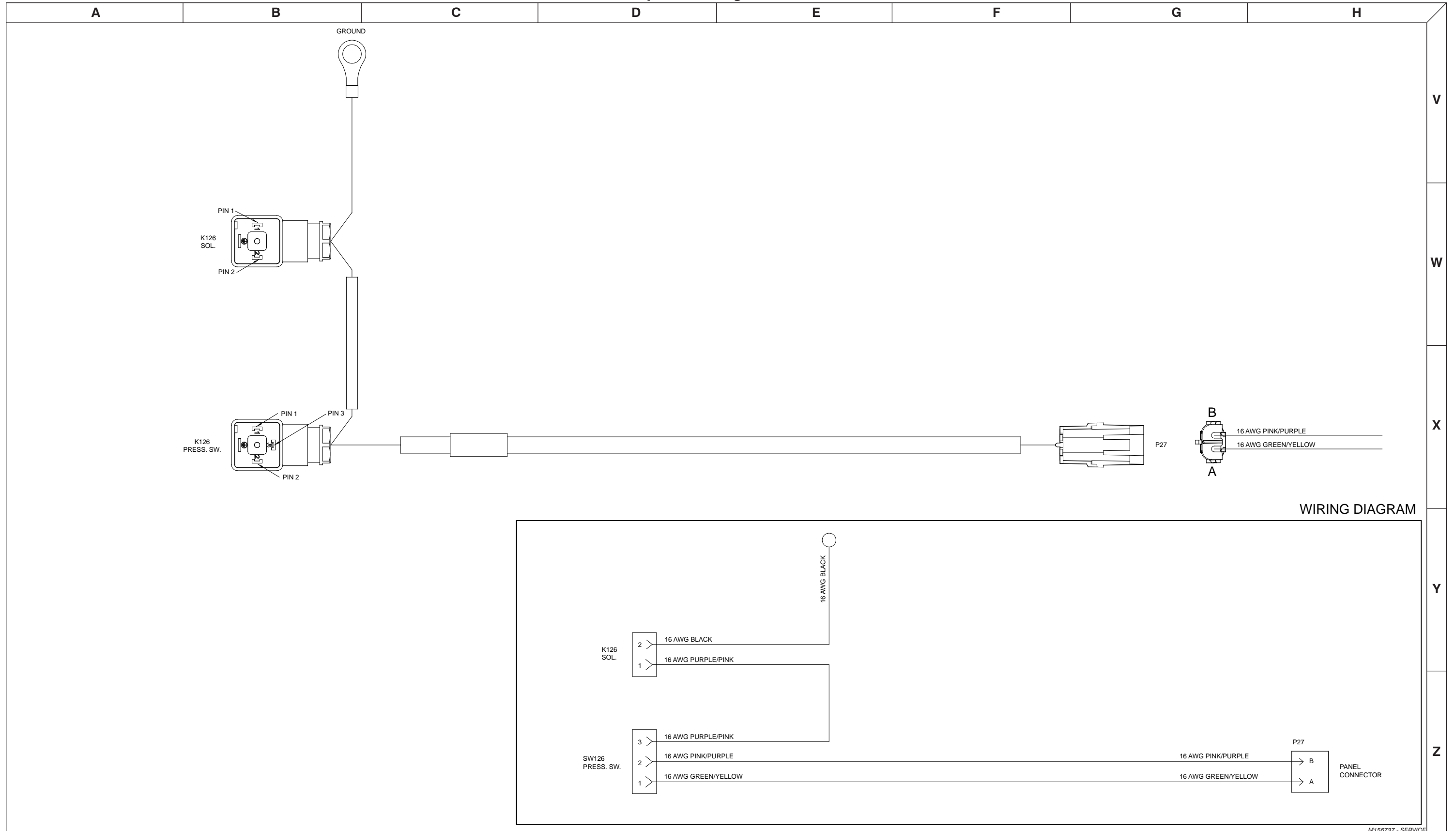

3.40 Hydraulic Schematic

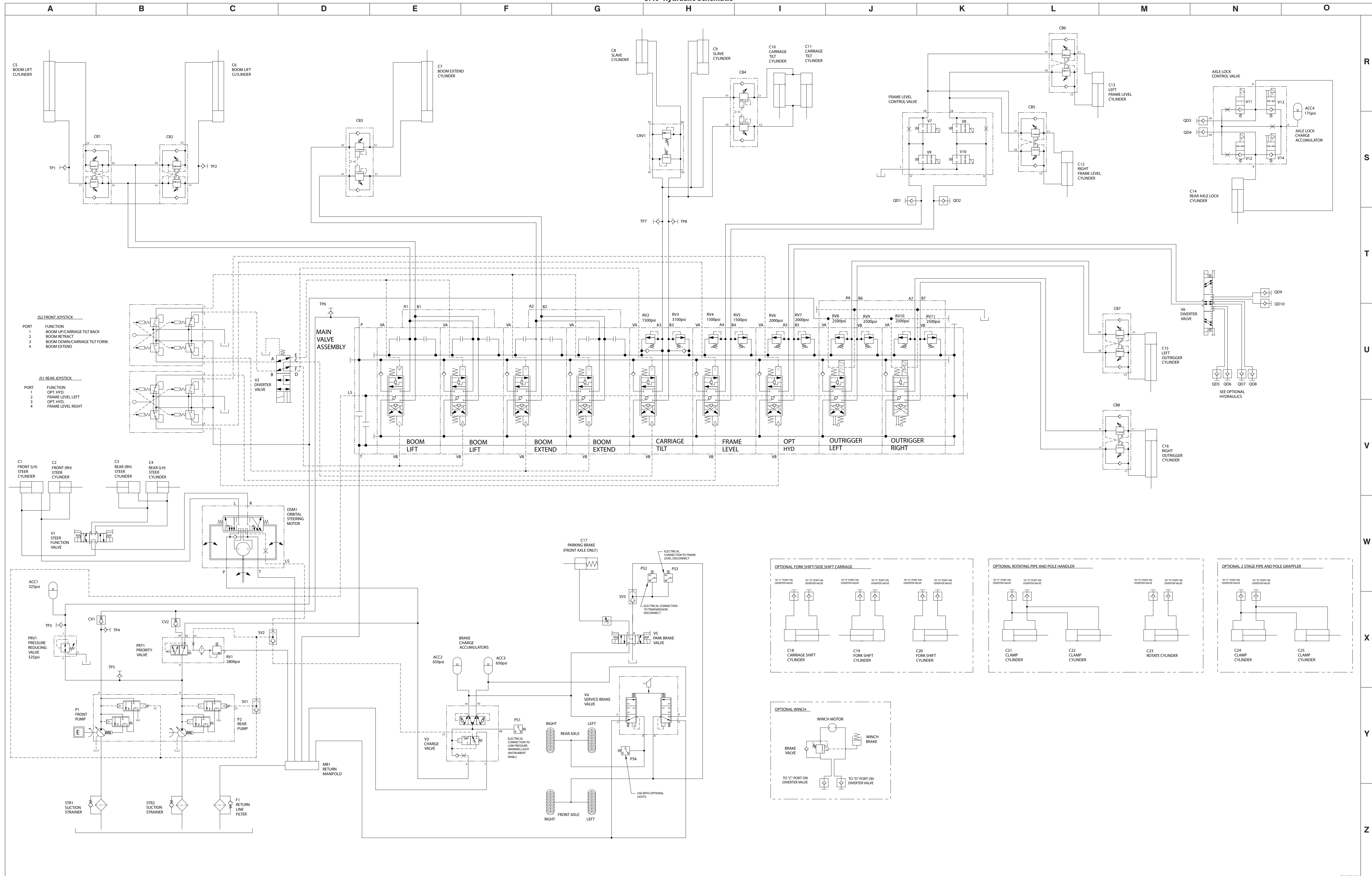

NOTE: To determine the correct hydraulic/electrical schematic that resembles your telehandler, refer to the "Table Of Contents" found at the beginning of this section.

3.41 Master Wiring Diagram 1 of 2

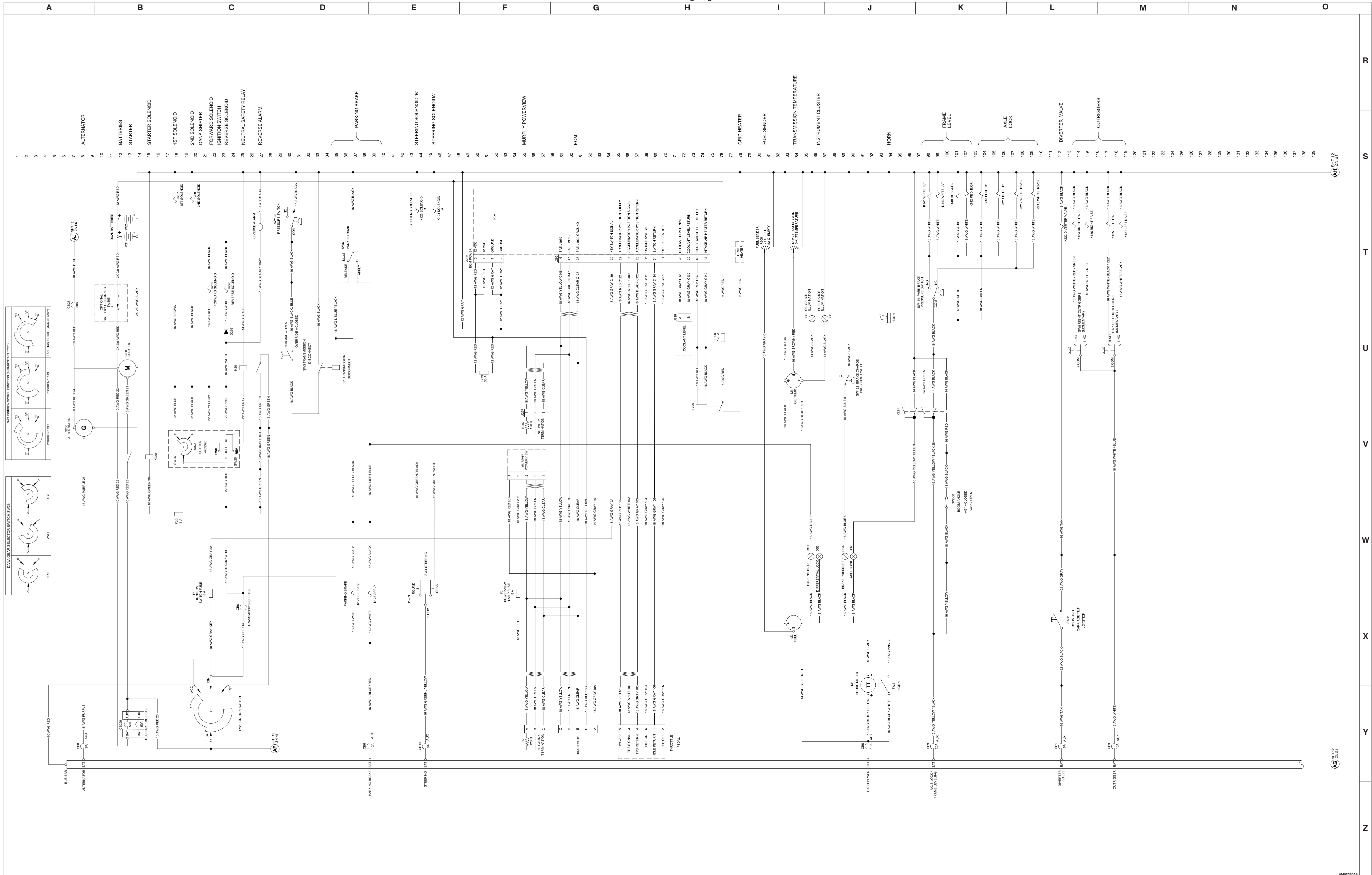

NOTE: To determine the correct hydraulic/electrical schematic that resembles your telehandler, refer to the "Table Of Contents" found at the beginning of this section.

3.41 Master Wiring Diagram 2 of 2

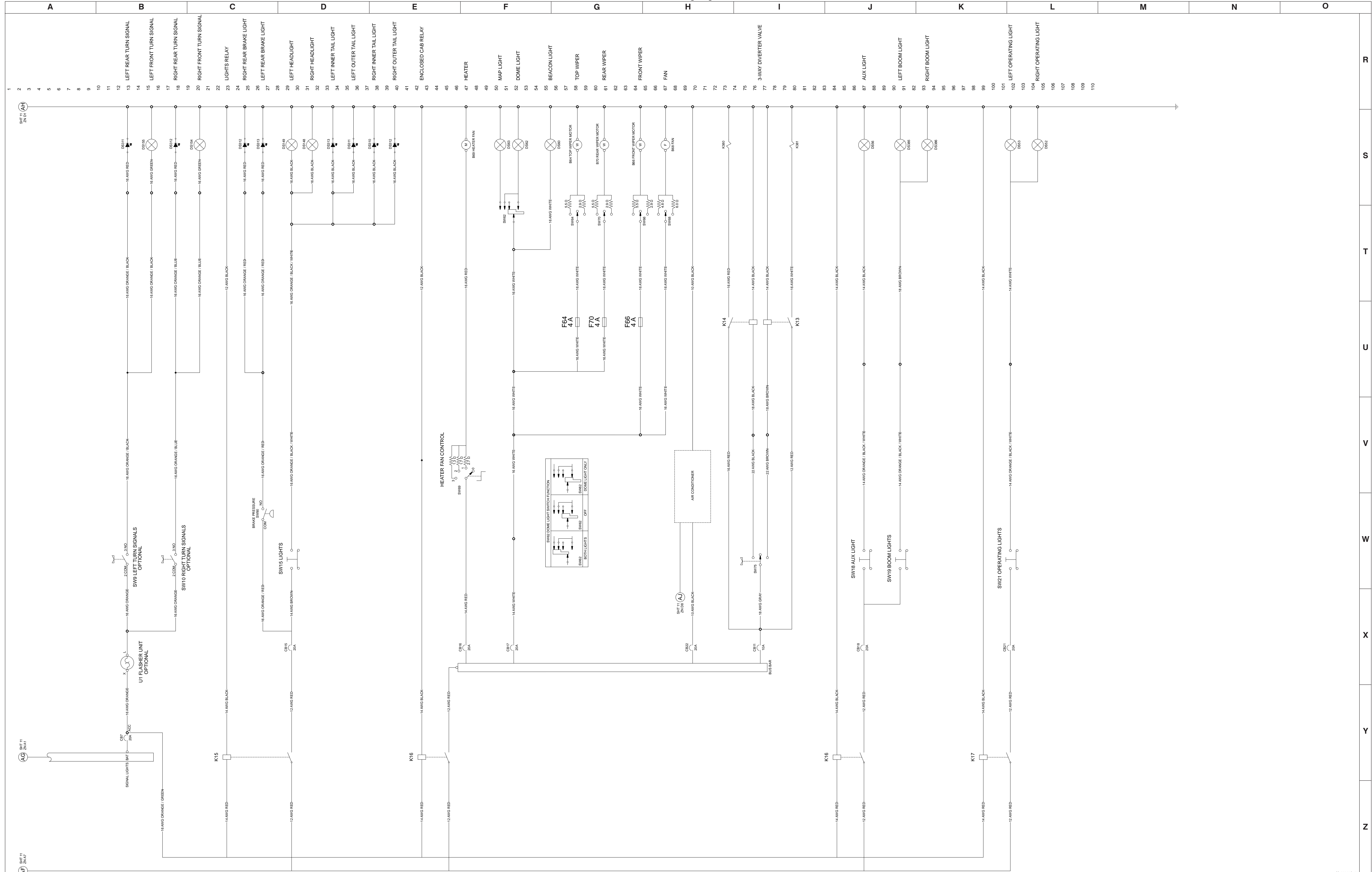

NOTE: To determine the correct hydraulic/electrical schematic that resembles your telehandler, refer to the "Table Of Contents" found at the beginning of this section.

Section 4 TROUBLESHOOTING INFORMATION

Table of Contents

Introduction.....	97
Electrical System	
4.1-1 All Controls Inoperative (No Crank).....	98
4.1-2 Engine Cranks but will not start.....	99
4.1-3 Can Bus Failure, no data/display on Murphy Powerview.....	99
4.1-4 No Throttle.....	100
4.1-5 No Drive (park brake releases).....	100
4.1-6 No Forward Drive.....	100
4.1-7 No reverse drive.....	101
4.1-8 3rd speed range only.....	101
4.1-9 No 1st speed range.....	101
4.1-10 No Drive (park brake does not release).....	101
4.1-11 Alternator not charging.....	102
4.1-12 Front steer mode only.....	102
4.1-13 No round steer mode.....	102
4.1-14 No crab steer mode.....	103
4.1-15 No carriage tilt function.....	103
4.1-16 No outrigger function.....	103
4.1-17 No right outrigger lower function.....	103
4.1-18 No right outrigger raise function.....	104
4.1-19 No left outrigger lower function.....	104
4.1-20 No left outrigger raise function.....	104
4.1-21 Rear axle locked, Front frame level in slow mode, brakes do not lock axle out, Axle lock light on, all boom angles.....	104
4.1-22 Rear axle and front frame level in slow mode, brake application locks out both axles, axle lock light on, all boom angles.....	105
4.1-23 Rear axle locked and front frame level operates normally, brake application locks out frame level, axle lock light on, all boom angles.....	105
4.1-24 Rear axle locked, front frame level operates normally, axle lock light off, below 45 degrees.....	105
4.1-25 Rear axle lock works normally, front frame level in slow mode, axle lock, light off, below 45 degrees.....	105
4.1-26 Front frame level does not lock out with brake application above 45 degrees.....	106
Hydraulic System	
4.2-1 All controls inoperative.....	107
4.2-2 All Boom Functions Inoperative.....	107
4.2-3 No Boom Raise.....	107
4.2-4 No Boom Lower.....	107
4.2-5 No Boom Extend.....	107
4.2-6 No Boom Retract.....	107
4.2-7 No Carriage Tilt Back.....	108
4.2-8 No Carriage Tilt Forward.....	108
4.2-9 No Frame Level Right.....	108
4.2-10 No Frame Level Left.....	109
4.2-11 No Auxiliary/Optional Hydraulic Control.....	109
4.2-12 No Right Outrigger Lower.....	110
4.2-13 No Right Outrigger Raise.....	110

Table of Contents (Continued)

4.2-14 No Left Outrigger Lower 110
4.2-15 No Left Outrigger Raise 110
4.2-16 Brake System Charging Constantly or Too Frequently 110
4.2-17 Hard or No Steering 111
4.2-18 Wheels go out of Synch. When in 4 wheel steer mode 111
4.2-19 Park Brake will not Release 111
4.2-20 Park Brake will not Engage 111

Introduction

The following pages contain the necessary troubleshooting information for locating and correcting electrical and hydraulic malfunctions that may arise. Careful and accurate analysis of the systems listed, will localize the problem more quickly than any other method.

Prior to performing any troubleshooting procedure, observe the following recommendations:

1. Isolate the major component in which the trouble occurs
2. Isolate whether the problem is electrical or hydraulic
3. Isolate and correct the specific problem

NOTE

If a specific problem is not listed, or after performing all necessary steps a problem can not be resolved; consult SKYJACK's service department.

The content of this section is divided into "probable cause" and "remedy." The information preceded by a number represents the "probable cause." The following line, noted by a dash represents the "remedy" to the "probable cause" directly above it. See example below for clarification.

1. Probable Cause
- [Remedy](#)

Electrical System

4.1-1 All Controls Inoperative (No Crank)

1. Battery cable(s) loose or disconnected.
 - Tighten or connect battery cable(s).
2. Battery discharged.
 - Charge battery.
3. Loose or broken wire #22 from starter to circuit breaker CB220.
 - Check continuity. Replace if defective.
4. Circuit breaker CB220 tripped or defective.
 - Check for defective wiring. Replace if defective.
5. Loose or broken wire #23 from circuit breaker CB220 to starter solenoid K220.
 - Check continuity. Replace if defective
6. Loose or broken wire #23 from circuit breaker CB220 to Ignition switch SW1.
 - Check continuity. Replace if defective.
7. Defective ignition switch SW1.
 - Replace if defective.
8. Loose or broken green wire from ignition switch SW1 to 3pin connector J9 (pin B).
 - Check continuity. Replace if defective.
9. Loose or broken green wire from 3pin connector P9 (pin B) to neutral safety relay K20 (pin30).
 - Check continuity. Replace if defective.
10. Loose or broken green wire from neutral safety relay K20 (pin 87) to 3pin connector P9 (pin C).
 - Check continuity. Replace if defective.
11. Loose or broken yellow wire from ignition switch SW1 to transmission shifter circuit breaker CB4.
 - Check continuity. Replace if defective.
12. Circuit breaker CB4 tripped or defective.
 - Check for defective wiring. Replace if defective.
13. Loose or broken black/white wire from CB4 to 3pin connector J9 (pin A).
 - Check continuity. Replace if defective.
14. Loose or broken red wire from 3pin connector P9 (pin A) to transmission shifter.
 - Check continuity. Replace if defective.
15. Defective shifter.
 - Check shifter. Replace if defective.
16. Loose or broken grey wire from shifter to neutral start relay K20 (pin 85).
 - Check continuity. Replace if defective.
17. Loose or broken black wire relay K20 (pin 86) to ground E1.
 - Check continuity. Replace if defective.
18. Defective neutral start relay K20.
 - Replace if defective.
19. Loose or broken green wire from 3pin connector J9 (pin C) to single wire connector P29.
 - Check continuity. Replace if defective.
20. Loose or broken grey wire from single pin connector P29 to 32pin connector P1 (pin12).
 - Check continuity. Replace if defective.
21. Loose or broken grey wire from 32pin connector J1 (pin12) to fuse F201.
 - Check continuity. Replace if defective.
22. Defective fuse F201.
 - Replace fuse.
23. Loose or broken red wire from fuse F201 to single pin connector J102.
 - Check continuity. Replace if defective.
24. Loose or broken green wire #36 from single pin connector P102 to starter solenoid K220.
 - Check continuity. Replace if defective.
25. Loose or broken black wire from starter solenoid K220 to ground.

Electrical System (Continued)

- Check continuity. Replace if defective.
26. Loose or broken green wire #21 from starter solenoid K220 to starter motor B200.
- Check continuity. Replace if defective.
27. Defective starter B200.
- Replace if defective.

4.1-2 Engine Cranks but will not start.

1. Loose or broken ECM battery cable from J204 to fuse F279.
 - Check continuity. Replace if defective.
2. Defective fuse F279.
 - Check for defective wiring, Replace Fuse.
3. Loose or broken red wire from fuse F297 Connector J296 (pin 3 and 4).
 - Check continuity. Replace if defective.
4. Loose or broken ECM ground from J296 (pin 1 and 2) to ground E204.
 - Check continuity. Replace if defective.
5. Loose or broken grey wire "key" from ignition switch SW1 to ignition switch fuse F1.
 - Check continuity. Replace if defective.
6. Defective fuse F1.
 - Check for defective wiring, Replace fuse.
7. Loose or broken grey wire 2A from fuse F1 to 32 pin connector P1 (Pin 11).
 - Check continuity. Replace if defective.
8. Loose or broken grey wire from J1 (pin 11) to Connector J295 (Pin 39).
 - Check continuity. Replace if defective.

NOTE

For other engine related problems, consult engine manufacturer's manual.

4.1-3 Can Bus Failure, no data/display on Murphy Powerview.

1. Loose or broken red wire T3 from ignition switch SW1 to fuse F2.
 - Check continuity. Replace if defective.
2. Defective fuse F2.
 - Check for defective wiring, Replace Fuse.
3. Loose or defective red wire 201 from fuse F2 to Connector J7 (pin 1) @ Murphy powerview.
 - Check continuity. Replace if defective.
4. Loose or defective grey wire 206/110 from connector J7 pin (pin 6) to connector P1 (pin 10).
 - Check continuity. Replace if defective.
5. Loose or defective grey wire from connector J1 (pin 10) to ground E204.
 - Check continuity. Replace if defective.
6. Loose or defective green wire from connector J7 (pin3) to connector P1 (pin 17).
 - Check continuity. Replace if defective.
7. Loose or defective green wire from connector J1 (pin 17) to connector J295 (pin 47).
 - Check continuity. Replace if defective.
8. Loose or defective yellow wire from connector J7 (pin 2) to connector P1 (pin 28).
 - Check continuity. Replace if defective.
9. Loose or defective yellow wire from connector J1 (pin 28) to connector J295 (pin 46).
 - Check continuity. Replace if defective.
10. Open or defective resistors R6 and R297.
 - Replace resistors.

Electrical System (Continued)

11. Defective Murphy Powerview.
 - Replace Murphy Powerview.

NOTE

For other engine related problems, consult engine manufacturer's manual.

4.1-4 No Throttle.

1. Loose or broken red wire 101 from throttle pedal connector J4 (pin 5) to connector P1 (pin 1)
 - Check continuity. Replace if defective.
2. Loose or broken red wire 129 from J1 (pin 1) to ECM connector B (pin 29)
 - Check continuity. Replace if defective.
3. Loose or broken grey wire 103 from throttle pedal connector J4 (pin 4) to connector P1 (pin 3)
 - Check continuity. Replace if defective.
4. Loose or broken black wire from J1 (pin 3) to ECM connector J295 (pin 23)
 - Check continuity. Replace if defective.
5. Loose or broken white wire 102 from throttle pedal connector J4 (pin 3) to connector P1 (pin 2).
 - Check continuity. Replace if defective.
6. Loose or broken white wire 130 from J1 (pin 2) to ECM connector J294 (pin 9)
 - Check continuity. Replace if defective.
7. Defective throttle pedal
 - Replace throttle pedal.

NOTE

For other engine related problems, consult engine manufacturer's manual.

4.1-5 No Drive (park brake releases)

1. Loose or defective black wire from J269 (pin 2) and J270 (pin 2) to single wire connector P124.
 - Check continuity. Replace if defective.
2. Loose or broken red wire from connector J124 to brake pressure switch SW125.
 - Check continuity. Replace if defective.
3. Defective pressure switch SW125.
 - Replace pressure switch.
4. Loose or broken black wire from brake pressure switch SW125 to ground E125.
 - Check continuity. Replace if defective.
5. Defective Shifter.
 - Replace shifter.

4.1-6 No Forward Drive.

1. Loose or broken red wire from connector J20 (pin C) to connector J269 (pin 1)
 - Check continuity. Replace if defective.
2. Defective forward solenoid K269.
 - Replace solenoid
3. Loose or broken black wire from solenoid connector J269 (pin 2) to ground.
 - Check continuity. Replace if defective.
4. Defective shifter.
 - Replace shifter

Electrical System (Continued)

4.1-7 No reverse drive

1. Loose or broken white wire from connector J20 (pin D) to diode D266
 - Check continuity. Replace if defective.
2. Open or defective diode D266.
 - Replace Diode.
3. Loose or broken white wire from diode D266 to connector J270 (pin1).
 - Check continuity. Replace if defective.
4. Defective reverse solenoid K270.
 - Replace solenoid
5. Loose or broken black wire from solenoid connector J270 (pin B) to ground.
 - Check continuity. Replace if defective.
6. Defective shifter.
 - Replace shifter

4.1-8 3rd speed range only.

1. Loose or broken black wire from connector J20 (pin B) to connector J268 (pin 1).
 - Check continuity. Replace if defective.
2. Defective 2nd solenoid K268.
 - Replace solenoid.
3. Loose or broken wire from connector J268 (pin B) to connector P264 (pin 2).
 - Check continuity. Replace if defective.
4. Loose or broken black wire from connector J264 (pin 2) to ground E267.
 - Check continuity. Replace if defective.
5. Defective shifter.
 - Replace shifter.

4.1-9 No 1st speed range.

1. Loose or broken brown wire from connector J20 (pin A) to connector J263 (pin 1)
 - Check continuity. Replace if defective.
2. Loose or broken brown wire from connector P263 (pin 1) to 1st solenoid connector J267 (pin A).
 - Check continuity. Replace if defective.
3. Defective 1st solenoid K267.
 - Replace solenoid
4. Loose or broken black wire from solenoid connector J267 (pin B) to connector P263 (pin 2).
 - Check continuity. Replace if defective.
5. Loose or broken black wire from connector J263 (pin 2) to ground E267.
 - Check continuity. Replace if defective.
6. Defective shifter.
 - Replace shifter.

4.1-10 No Drive (park brake does not release)

1. Loose or broken red wire from ignition switch SW1 to Accessory Circuit breaker buss bar.
 - Check continuity. Replace if defective.
2. Tripped or defective circuit breaker CB6.
 - Check for defective wiring, Replace circuit breaker.
3. Loose or broken light blue/red wire from circuit breaker CB6 to connector J10 (pin D).
 - Check continuity. Replace if defective.
4. Loose or broken light blue/red wire from connector P10 (pin D) to Hirschman connectors J127 and J128(pins 1).
 - Check continuity. Replace if defective.

Electrical System (Continued)

5. Defective park brake release coil K127.
 - Replace Coil.
6. Loose or broken light blue/black wire from Hirschman connector J127 (pin 2) to connector P10 (pin B).
 - Check continuity. Replace if defective.
7. Loose or broken light blue/black wire from connector J 10 (pin B) to park brake switch SW6.
 - Check continuity. Replace if defective.
8. Defective park brake switch SW6.
 - Replace switch.
9. Loose or broken black wire from park brake switch SW6 to ground E2.
 - Check continuity. Replace if defective.

4.1-11 Alternator not charging

1. Loose or broken red wire from ignition switch SW1 to Accessory Circuit breaker buss bar.
 - Check continuity. Replace if defective.
2. Tripped or defective circuit breaker CB8.
 - Check for defective wiring, Replace circuit breaker.
3. Loose or broken purple wire #25 from circuit breaker CB8 to Connector P2 (pin8).
 - Check continuity. Replace if defective.
4. Loose or broken purple wire #25 from connector J2 (pin 8) to single wire connector J220.
 - Check continuity. Replace if defective.
5. Loose or broken purple wire #25 from Connector P220 to alternator connector J289 (pin C).
 - Check continuity. Replace if defective.
6. Loose or broken red wire #24 from alternator "BAT" terminal to starter.
 - Check continuity. Replace if defective.
7. Defective alternator.
 - Replace alternator.

4.1-12 Front steer mode only

1. Loose or broken red wire from ignition switch SW1 to Accessory Circuit breaker buss bar.
 - Check continuity. Replace if defective.
2. Tripped or defective circuit breaker CB10.
 - Check for defective wiring, Replace circuit breaker.
3. Loose or broken green/yellow wire from circuit breaker CB10 to Steer switch SW4.
 - Check continuity. Replace if defective.
4. Defective steer switch SW4.
 - Replace switch
5. Loose or broken black wire from steering solenoid A & B coils K124 and K125 to connector J11 (pin C).
 - Check continuity. Replace if defective.
6. Loose or broken black wire form connector P11 (pin C) to ground E1.
 - Check continuity. Replace if defective.

4.1-13 No round steer mode

1. Defective steer switch SW4.
 - Replace switch.
2. Loose or broken green/black wire from steer switch to connector P11 (pin A).
 - Check continuity. Replace if defective.
3. Loose or broken green/black wire from connector J11 (pin A) to steering solenoid B coil K125.
 - Check continuity. Replace if defective.
4. Defective steering solenoid K125.
 - Replace solenoid.

Electrical System (Continued)

4.1-14 No crab steer mode

1. Defective steer switch SW4.
 - Replace switch.
2. Loose or broken green/white wire from steer switch to connector P11 (pin B).
 - Check continuity. Replace if defective.
3. Loose or broken green/white wire from connector J11 (pin B) to steering solenoid A coil K124.
 - Check continuity. Replace if defective.
4. Defective steering solenoid K124.
 - Replace solenoid.

4.1-15 No carriage tilt function

1. Loose or broken red wire from ignition switch SW1 to Accessory Circuit breaker buss bar.
 - Check continuity. Replace if defective.
2. Tripped or defective circuit breaker CB1.
 - Check for defective wiring, Replace circuit breaker.
3. Loose or broken tan wire from circuit breaker CB1 to connector J40.
 - Check continuity. Replace if defective.
4. Defective carriage tilt switch SW11.
 - Replace switch.
5. Loose or broken white wire from connector P41 to Hirschman connector J222 at pilot diverter valve K222.
 - Check continuity. Replace if defective.
6. Defective diverter valve K22.
 - Replace diverter valve.
7. Loose or broken black wire from pilot diverter valve K222 Hirschman connector J222 to ground E222.
 - Check continuity. Replace if defective.

4.1-16 No outrigger function

1. Tripped or defective circuit breaker CB3.
 - Check for defective wiring, Replace circuit breaker.
2. Loose or broken white wire from circuit breaker CB3 to connector J17 (pin A).
 - Check continuity. Replace if defective.
3. Loose or broken white jumper wire on connector J17 (pin A to pin B).
 - Check continuity. Replace if defective.
4. Loose or broken white/blue wire from connector J 17 (pin B) to common on outrigger switches SW7 and SW8
 - Check continuity. Replace if defective.
5. Loose or broken black wire from splice S137 to Ground E137 .
 - Check continuity. Replace if defective.

4.1-17 No right outrigger lower function

1. Defective right outrigger switch SW8.
 - Replace switch.
2. Loose or broken white/red/green wire from right outrigger switch to connector J18 (pin B).
 - Check continuity. Replace if defective.
3. Loose or broken white/red/green wire from connector P18 (pin B) to right lower solenoid connector J134 (pin 1)
 - Check continuity. Replace if defective.
4. Defective right lower solenoid K134.
 - Replace solenoid.
5. Loose or broken black wire from right lower solenoid connector J134 (pin 2) to ground E137.

Electrical System (Continued)

- Check continuity. Replace if defective.

4.1-18 No right outrigger raise function

1. Defective right outrigger switch SW8.
 - Replace switch.
2. Loose or broken white/red wire from right outrigger switch to connector J18 (pin A).
 - Check continuity. Replace if defective.
3. Loose or broken white/red/green wire from connector P18 (pin A) to right raise solenoid connector J136 (pin 1)
 - Check continuity. Replace if defective.
4. Defective right raise solenoid K136.
 - Replace solenoid.
5. Loose or broken black wire from right raise solenoid connector J136 (pin 2) to ground E137.
 - Check continuity. Replace if defective.

4.1-19 No left outrigger lower function

1. Defective left outrigger switch SW7.
 - Replace switch.
2. Loose or broken white/black/red wire from left outrigger switch to connector J18 (pin D).
 - Check continuity. Replace if defective.
3. Loose or broken white/black/red wire from connector P18 (pin D) to left lower solenoid connector J135 (pin 1)
 - Check continuity. Replace if defective.
4. Defective left lower solenoid K135.
 - Replace solenoid.
5. Loose or broken black wire from left lower solenoid connector J135 (pin 2) to ground E137.
 - Check continuity. Replace if defective.

4.1-20 No left outrigger raise function

1. Defective left outrigger switch SW7.
 - Replace switch.
2. Loose or broken white/black wire from left outrigger switch to connector J18 (pin C).
 - Check continuity. Replace if defective.
3. Loose or broken white/black wire from connector P18 (pin C) to left raise solenoid connector J137 (pin 1)
 - Check continuity. Replace if defective.
4. Defective left raise solenoid K137.
 - Replace solenoid.
5. Loose or broken black wire from left raise solenoid connector J137 (pin 2) to ground E137.
 - Check continuity. Replace if defective.

4.1-21 Rear axle locked, Front frame level in slow mode, brakes do not lock axle out, Axle lock light on, all boom angles.

1. Loose or broken red wire from ignition switch SW1 to Accessory Circuit breaker buss bar.
 - Check continuity. Replace if defective.
2. Tripped or defective circuit breaker CB9.
 - Check for defective wiring, Replace circuit breaker.
3. Loose or defective yellow/black wire from circuit breaker CB9 to connector P2 (pin 10).
 - Check continuity. Replace if defective.
4. Loose or defective yellow/black wire #28 from connector J2 (pin 10) to relay K221 (pin 6).
 - Check continuity. Replace if defective.

Electrical System (Continued)

4.1-22 Rear axle and front frame level in slow mode, brake application locks out both axles, axle lock light on, all boom angles.

1. Loose or broken yellow wire from relay K221 (pin 6) to connector P247 (pin A).
 - Check continuity. Replace if defective.
2. Loose or broken black wire form connector J247 (pin A) to single wire connector J215.
 - Check continuity. Replace if defective.
3. Loose or broken wire from connector P215 to mercury switch SW300.
 - Check continuity. Replace if defective.
4. Defective mercury switch SW360.
 - Replace if defective.
5. Loose or broken wire from mercury switch SW300 to single wire connector J216.
 - Check continuity. Replace if defective.
6. Loose or broken white wire from connector P216 to splice SPL210.
 - Check continuity. Replace if defective.

4.1-23 Rear axle locked and front frame level operates normally, brake application locks out frame level, axle lock light on, all boom angles.

1. Loose or broken green wire from connector P247 (pin B) to relay K221 (pin 8).
 - Check continuity. Replace if defective.
2. Defective relay K221.
 - Replace if defective.
3. Loose or broken black wire from relay K221 (pin 7) to ground E221.
 - Check continuity. Replace if defective.

4.1-24 Rear axle locked, front frame level operates normally, axle lock light off, below 45 degrees.

1. Loose or broken white wires from splice SPL210 to solenoids K210 and K211.
 - Check continuity. Replace if defective.
2. Defective solenoid K210 or K211.
 - Replace if defective.
3. Defective black wire from solenoids K210 and K211 to ground E210.
 - Check continuity. Replace if defective.

4.1-25 Rear axle lock works normally, front frame level in slow mode, axle lock, light off, below 45 degrees.

1. Loose or defective green wire from connector J247 (pin B) to solenoids K140 and K142 (pin 1).
 - Check continuity. Replace if defective.
2. Defective solenoid K140 or K142.
 - Replace if defective.
3. Loose or defective black wire from solenoids K140 and K142 (pin 2) to ground E140.
 - Check continuity. Replace if defective.

Electrical System (Continued)

4.1-26 Front frame level does not lock out with brake application above 45 degrees.

1. Lose or defective black wire from relay K221 (pin2) to connector P247 (pin C).
 - Check continuity. Replace if defective.
2. Loose or defective black wire from connector J247 (pin C) to brake pressure switch SW114 connector (pin 1).
 - Check continuity. Replace if defective.
3. Brake pressure switch SW114 out of adjustment or defective.
 - Adjust switch. Replace if defective.
4. Loose or broken white wire from to brake pressure switch SW114 connector (pin 3) to frame level dump solenoids K141 and K143 (pin 1).
 - Check continuity. Replace if defective.
5. Defective solenoids K141 or K143.
 - Check continuity. Replace if defective.
6. Loose or defective green wire from solenoids K141 and K143 (pin 2) to ground E113.
 - Check continuity. Replace if defective.

NOTE

If only one relay is bad and one is OK, you will have steer in one direction only.

Hydraulic System

4.2-1 All controls inoperative

1. Worn or defective pump shaft or coupling.
 - Check pump shaft and coupling. Replace if defective.
2. No PTO rotation.
 - Repair transmission, or flex plate.
3. Hydraulic oil level low.
 - Check oil level. Fill to proper level.
4. System pump P2 is out of adjustment or is defective.
 - Refer to section 5 for pump set up procedure. Repair or replace if defective.

4.2-2 All Boom Functions Inoperative.

1. Stuck or defective pressure reducing valve PRV1.
 - Set valve to specifications. Check o-rings and clean valve. Repair or replace valve as required.
2. Stuck or defective priority valve PRT1 .
 - Clean valve. Check operation of valve. Repair or replace valve as required.

4.2-3 No Boom Raise

1. Stuck or defective joystick JS2.
 - Clean valve. Check operation of valve. Repair or replace valve as required.
2. Stuck or defective carriage tilt diverter valve V2.
 - Clean valve. Check operation of valve. Repair or replace valve as required.
3. Stuck or defective lift valve sections.
 - Clean valve. Check operation of valve. Repair or replace valve as required.
4. Stuck or defective lift counterbalance valves CB1, CB2.
 - Clean valve. Check o-rings on valve. Repair or replace valve as required.
5. Defective lift cylinder C5 and/or C6.
 - Check seals on cylinder. Replace as necessary. Replace cylinder if defective.

4.2-4 No Boom Lower

1. Stuck or defective joystick JS2.
 - Clean valve. Check operation of valve. Repair or replace valve as required.
2. Stuck or defective carriage tilt diverter valve V2.
 - Clean valve. Check operation of valve. Repair or replace valve as required.
3. Stuck or defective lift valve sections.
 - Clean valve. Check operation of valve. Repair or replace valve as required.
4. Stuck or defective lift counterbalance valves CB1, CB2.
 - Clean valve. Check o-rings on valve. Repair or replace valve as required.
5. Defective lift cylinder C5 and/or C6.
 - Check seals on cylinder. Replace as necessary. Replace cylinder if defective.

4.2-5 No Boom Extend

1. Stuck or defective joystick JS2.
 - Clean valve. Check operation of valve. Repair or replace valve as required.
2. Stuck or defective extension valve sections.
 - Clean valve. Check operation of valve. Repair or replace valve as required.
3. Stuck or defective extension counterbalance valve CB3.
 - Clean valve. Check o-rings on valve. Repair or replace valve as required.
4. Defective extension cylinder C7.
 - Check seals on cylinder. Replace as necessary. Replace cylinder if defective.

4.2-6 No Boom Retract

Hydraulic System (Continued)

1. Stuck or defective joystick JS2.
 - Clean valve. Check operation of valve. Repair or replace valve as required.
2. Stuck or defective extension valve section.
 - Clean valve. Check operation of valve. Repair or replace valve as required.
3. Stuck or defective extension counterbalance valve CB3.
 - Clean valve. Check o-rings on valve. Repair or replace valve as required.
4. Defective extension cylinder C7.
 - Check seals on cylinder. Replace as necessary. Replace cylinder if defective.

4.2-7 No Carriage Tilt Back

1. Stuck or defective joystick JS2.
 - Clean valve. Check operation of valve. Repair or replace valve as required.
2. Stuck or defective carriage tilt diverter valve V2.
 - Clean valve. Check operation of valve. Repair or replace valve as required.
3. Stuck or defective carriage tilt valve section.
 - Clean valve. Check operation of valve. Repair or replace valve as required.
4. Stuck or defective port relief valve RV3.
 - Set valve to specifications. Check o-rings and clean valve. Repair or replace valve as required.
5. Stuck or defective carriage tilt counterbalance valve CB4.
 - Clean valve. Check o-rings on valve. Repair or replace valve as required.
6. Defective carriage slave cylinder C8 and/or C9.
 - Check seals on cylinder. Replace as necessary. Replace cylinder if defective.
7. Defective carriage tilt cylinder C10 and/or C11.
 - Check seals on cylinder. Replace as necessary. Replace cylinder if defective.
8. Stuck or defective Crossover relief valve CRV1.
 - Set valve to specifications. Check o-rings and clean valve. Repair or replace valve as required.

4.2-8 No Carriage Tilt Forward

1. Stuck or defective joystick JS2.
 - Clean valve. Check operation of valve. Repair or replace valve as required.
2. Stuck or defective carriage tilt diverter valve V2.
 - Clean valve. Check operation of valve. Repair or replace valve as required.
3. Stuck or defective carriage tilt valve section.
 - Clean valve. Check operation of valve. Repair or replace valve as required.
4. Stuck or defective port relief valve RV2.
 - Set valve to specifications. Check o-rings and clean valve. Repair or replace valve as required.
5. Stuck or defective carriage tilt counterbalance valve CB4.
 - Clean valve. Check o-rings on valve. Repair or replace valve as required.
6. Defective carriage slave cylinder C8 and/or C9.
 - Check seals on cylinder. Replace as necessary. Replace cylinder if defective.
7. Defective carriage tilt cylinder C10 and/or C11.
 - Check seals on cylinder. Replace as necessary. Replace cylinder if defective.
8. Stuck or defective Crossover relief valve CRV1.
 - Set valve to specifications. Check o-rings and clean valve. Repair or replace valve as required.

4.2-9 No Frame Level Right.

1. Stuck or defective joystick JS1.
 - Clean valve. Check operation of valve. Repair or replace valve as required.
2. Stuck or defective frame level valve section.
 - Clean valve. Check operation of valve. Repair or replace valve as required.

Hydraulic System (Continued)

3. Stuck or defective port relief valve RV4.
 - Set valve to specifications. Check o-rings and clean valve. Repair or replace valve as required.
4. Stuck or defective frame level counterbalance valve CB5 and/or CB6.
 - Clean valve. Check o-rings on valve. Repair or replace valve as required.
5. Stuck or defective frame level dump valve V9.
 - Clean valve. Check o-rings on valve. Repair or replace valve as required.
6. Defective frame level cylinder C12 and/or C13.
 - Check seals on cylinder. Replace as necessary. Replace cylinder if defective.

4.2-10 No Frame Level Left.

1. Stuck or defective joystick JS1.
 - Clean valve. Check operation of valve. Repair or replace valve as required.
2. Stuck or defective frame level valve section.
 - Clean valve. Check operation of valve. Repair or replace valve as required.
3. Stuck or defective port relief valve RV5.
 - Set valve to specifications. Check o-rings and clean valve. Repair or replace valve as required.
4. Closed or obstructed flow control valve FC1.
 - Clean valve. Check operation of valve. Adjust, repair or replace valve as required.
5. Stuck or defective frame level counterbalance valve CB4 and/or CB6.
 - Clean valve. Check o-rings on valve. Repair or replace valve as required.
6. Stuck or defective frame level dump valve V10.
 - Clean valve. Check o-rings on valve. Repair or replace valve as required.
7. Defective frame level cylinder C11 and/or C12.
 - Check seals on cylinder. Replace as necessary. Replace cylinder if defective.

4.2-11 No Auxiliary/Optional Hydraulic Control

1. Stuck or defective joystick JS1.
 - Clean valve. Check operation of valve. Repair or replace valve as required.
2. Stuck or defective Auxiliary valve section.
 - Clean valve. Check operation of valve. Repair or replace valve as required.
3. Stuck or defective port relief valve RV7 and/or RV8.
 - Set valve to specifications. Check o-rings and clean valve. Repair or replace valve as required.
4. Closed or obstructed flow control valve FC3 and/or FC4.
 - Clean valve. Check operation of valve. Adjust, repair or replace valve as required.
5. Stuck or defective Auxiliary counterbalance valve.
 - Clean valve. Check o-rings on valve. Repair or replace valve as required.
6. Stuck or defective Diverter valve V6.
 - Clean valve. Check operation of valve. Repair or replace valve as required.
7. Defective Auxiliary cylinder(s).
 - Check seals on cylinder. Replace as necessary. Replace cylinder if defective.

Hydraulic System (Continued)

4.2-12 No Right Outrigger Lower

1. Stuck or defective right lower pilot valve.
 - Clean valve. Check operation of valve. Repair or replace valve as required.
2. Stuck or defective right outrigger valve section.
 - Clean valve. Check operation of valve. Repair or replace valve as required.
3. Stuck or defective port relief valve RV10.
 - Clean valve. Check operation of valve. Adjust, repair or replace valve as required.
4. Stuck or defective right outrigger counterbalance valve CB8.
 - Set valve to specifications. Check o-rings and clean valve. Repair or replace valve as required.
5. Defective right outrigger cylinder C16.
 - Check seals on cylinder. Replace as necessary. Replace cylinder if defective.

4.2-13 No Right Outrigger Raise

1. Stuck or defective right raise pilot valve.
 - Clean valve. Check operation of valve. Repair or replace valve as required.
2. Stuck or defective right outrigger valve section.
 - Clean valve. Check operation of valve. Repair or replace valve as required.
3. Stuck or defective port relief valve RV11.
 - Set valve to specifications. Check o-rings and clean valve. Repair or replace valve as required.
4. Stuck or defective right outrigger counterbalance valve CB8.
 - Clean valve. Check o-rings on valve. Repair or replace valve as required.
5. Defective right outrigger cylinder C16.
 - Check seals on cylinder. Replace as necessary. Replace cylinder if defective.

4.2-14 No Left Outrigger Lower

1. Stuck or defective left lower pilot valve.
 - Clean valve. Check operation of valve. Repair or replace valve as required.
2. Stuck or defective left outrigger valve section.
 - Clean valve. Check operation of valve. Repair or replace valve as required.
3. Stuck or defective port relief valve RV8.
 - Set valve to specifications. Check o-rings and clean valve. Repair or replace valve as required.
4. Stuck or defective left outrigger counterbalance valve CB7.
 - Clean valve. Check o-rings on valve. Repair or replace valve as required.
5. Defective left outrigger cylinder C15.
 - Check seals on cylinder. Replace as necessary. Replace cylinder if defective.

4.2-15 No Left Outrigger Raise

1. Stuck or defective left raise pilot valve.
 - Clean valve. Check operation of valve. Repair or replace valve as required.
2. Stuck or defective left outrigger valve section.
 - Clean valve. Check operation of valve. Repair or replace valve as required.
3. Stuck or defective port relief valve RV9.
 - Set valve to specifications. Check o-rings and clean valve. Repair or replace valve as required.
4. Stuck or defective left outrigger counterbalance valve CB7.
 - Clean valve. Check o-rings on valve. Repair or replace valve as required.
5. Defective left outrigger cylinder C15.
 - Check seals on cylinder. Replace as necessary. Replace cylinder if defective.

4.2-16 Brake System Charging Constantly or Too Frequently.

1. Stuck or defective priority valve PRT1.

Hydraulic System (Continued)

- Set valve to specifications. Check o-rings and clean valve. Repair or replace valve as required.
- 2. Stuck or defective brake charge valve V3.
 - Set valve to specifications. Check o-rings and clean valve. Repair or replace valve as required.
- 3. Defective accumulators ACC2 and/or ACC3.
 - Charge with nitrogen to specification. Replace if defective.
- 4. Stuck or defective service brake valve V5.
 - Remove from system, check brake charge cycle time. Replace if defective.

4.2-17 Hard or No Steering

1. Stuck or defective priority valve PRT1.
 - Set valve to specifications. Check o-rings and clean valve. Repair or replace valve as required.
2. Stuck or defective steering motor OSM1.
 - Check o-rings and clean valve. Repair or replace valve as required.
3. Defective steer cylinder C1 and/or C2, C3, C4.
 - Check seals on cylinder. Replace as necessary. Replace cylinder if defective.

4.2-18 Wheels go out of Synch. When in 4 wheel steer mode

1. Stuck or defective steer function valve V1
 - Clean valve. Check operation of valve. Repair or replace valve as required.
2. Defective steer cylinder C1 and/or C2, C3, C4.
 - Check seals on cylinder. Replace as necessary. Replace cylinder if defective.

4.2-19 Park Brake will not Release

1. Stuck or defective park brake valve V5.
 - Clean valve. Check o-rings on valve. Repair or replace valve as required.
2. Bypassing or defective parking brake C17.
 - Check seals, replace as necessary. Replace if defective.

4.2-20 Park Brake will not Engage

1. Defective park brake C17.
 - Repair or replace as necessary.
2. Park brake valve V5 stuck in shifted position.
 - Check valve. Replace if defective.
3. Park brake out of adjustment.
 - See section 5 for park brake adjustment procedure.

Section 5 PROCEDURES

List of Procedures

Engine and Transmission

General	115
Safety and Workmanship	115
5.1-1 Engine and Components	115
5.1-2 Fault Codes for Quantum Engines	115
5.1-3 PowerView General Information	116
Display Parameters	116
Keypad Functions	116
PowerView Menus (First Time Start Up)	117
Error Messages	130
5.1-4 Replace Engine Oil and Filter	133
5.1-5 Check Engine Air Filter	134
5.1-6 Replace Fuel Filter	134
5.1-7 Check Fan Drive Belt	134
5.1-8 Check Transmission Filter Breather	135
5.1-9 Change Transmission Fluid and Filter	135

Hydraulic System

5.2-1 Check Hydraulic Oil	136
5.2-2 Change Hydraulic Tank Filter	136
5.2-3 Change Hydraulic Oil	136
5.2-4 Bleeding Hydraulic Circuits	137
Bleed Carriage Tilt Circuit	137
Bleed Boom Extend/Retract Circuit	137
Bleed Boom Raise/Lower Circuit	137
Bleed Frame Level Circuit	137
Bleed Auxiliary/Optional Circuits	137
Bleed Outriggers Circuit	137
Bleed Brake Circuit	137

Pressure Adjustment Procedures

5.3-1 Piston Pump Pressure	138
5.3-2 Port Relief Pressure	138
5.3-3 Priority Valve Relief Pressure	139
5.3-4 Pilot Pressure	139
5.3-5 Check Brake Accumulators	140
5.3-6 Charging Brake Accumulators	140
5.3-7 Charging Rear Axle Lock System	141

Boom

5.4-1 Boom Hose Replacement	142
5.4-2 Boom Chain Replacement and Adjustment	143
Extend Chain	143
Retract Chain	143
Chain Adjustment	144

List of Procedures (Continued)

5.4-3 Check Slide Pads.....144
 5.4-4 Replacing and Shimming Slide Pads.....144

Axles

5.5-1 Change Oil in Axles145
 5.5-2 Check Oil Level in Torque Hub.....145

Grease Points

5.6-1 Frame Grease Points146
 5.6-2 Boom Grease Points.....147
 5.6-3 Drive Axle Grease Points148
 5.6-4 Drive Shaft Grease Points.....148

Tires

5.7-1 Check Lug Nut Torque.....149

General

The following information is provided to assist you in the use and application of servicing and maintenance procedures contained in this chapter.

Safety and Workmanship

Your safety, and that of others, is the first consideration when engaging in the maintenance of equipment. Always be conscious of weight. Never attempt to move heavy parts without the aid of a mechanical device. Do not allow heavy objects to rest in an unstable position. When raising a portion of the equipment, ensure that adequate support is provided.

Engine and Transmission**5.1-1 Engine and Components**

The engine used on the ZB200XX Zoom Boom models is a Cummins QSB4.5C160T3.

Engine service information can be found in the Cummins Engine Manuals. It should be noted that engine warranty service work is to be directed to and administered by your nearest authorized Cummins dealer/distributor. Skyjack cannot enter into any warranty service work requirements.

The basic Cummins engine warranty covers the entire engine from the fan to the fly wheel including all internal parts as well as the following list of parts supplied with the engine as original:

1. Starter
2. Alternator
3. Injectors
4. Fuel Pump
5. Fuel Solenoid
6. Water Pump

The air cleaner and exhaust system are not part of the engine package, and are covered later in this manual.

The cooling system including radiator and hoses are also not part of the engine package and are covered later in this manual.

5.1-2 Fault Codes for Quantum Engines

HHP Quantum 45/60/78 Fault Severity Levels		
Fault Severity Level	Fault Severity Function	Action to be taken by operator
Red	Stop	Stop Engine Now - Damage imminent
Yellow	Warning	Warning - Engine may continue to run, but must be repaired the same day.
No Lamp	Maintenance	Maintenance - Repair at next PM
No Lamp	None - Information only	None - No lamp action

5.1-3 PowerView General Information



WARNING

- Before beginning installation of this Murphy product
- Disconnect all electrical power to the machine
- Make sure the machine cannot operate during installation
- Follow all safety warnings of the manufacturer
- Read and follow all installation instructions

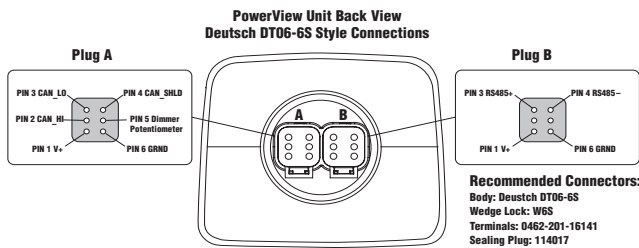

Display Parameters

The following are some of the engine and transmission parameters displayed by the PowerView in English or Metric units as well as in Spanish, French, or German (when applicable, consult engine or transmission manufacturer for SAE J1939 supported parameters):

- Engine RPM
- Engine Hours
- Machine Hours
- System Voltage
- % Engine Load at the current RPM
- Coolant Temperature
- Oil Pressure
- Fuel Economy
- Throttle Position
- Engine Manifold Air Temperature
- Current Fuel Consumption
- Active Service Codes
- Stored Service Codes (when supported)
- Set Units for Display (English or Metric)

Faceplate Features

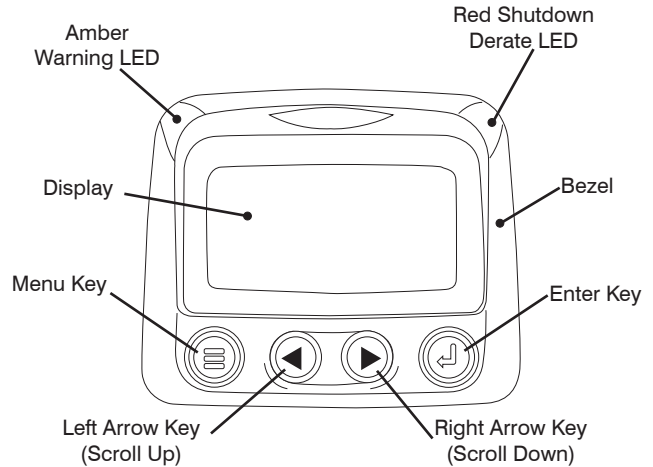

Keypad Functions

The keypad on the PowerView is a capacitive touch sensing system. There are no mechanical switches to wear or stick, and the technology has been time proven in many applications. It operates in extreme temperatures, with gloves, through ice, snow, mud, grease, etc., and it allows complete sealing of the front of the PowerView. The 'key is touched' feedback is provided by flashing the screen. The keys on the keypad perform the following functions:

Menu Key - The Menu Key is touched to either enter or exit the menu screens.

Left Arrow - The Left Arrow Key is touched to scroll through the screen either moving the parameter selection toward the left or upward.

Right Arrow - The Right Arrow Key is touched to scroll through the screen either moving the parameter selection toward the right or downward.

Enter Key - The Enter Key (also known as Enter Button) is touched to select the parameter that is highlighted on the screen.

PowerView Menus (First Time Start Up)

1. When power is first applied to the PowerView, the "Logo" is displayed.



2. The "Wait to Start" message will be displayed for engines with a pre-startup sequence. Once the "Wait to Start" message is no longer displayed the operator may start the engine. Note: Displays only when SAE J1939 message is supported by engine manufacturer.



3. Once the engine has started the single engine parameter is displayed.

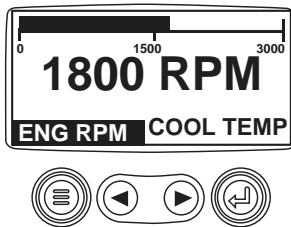

Main Menu Navigation

1. Starting at the single or four engine parameter display, touch "Menu".

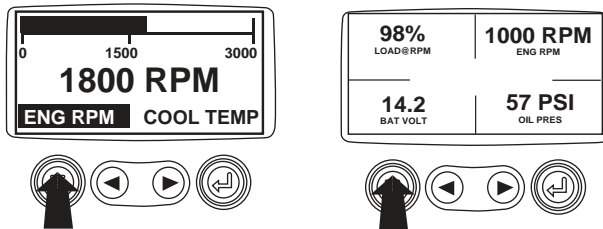

2. The first seven items of the "Main Menu" will be displayed. Touching the "Arrow Buttons" will scroll through the menu selection.

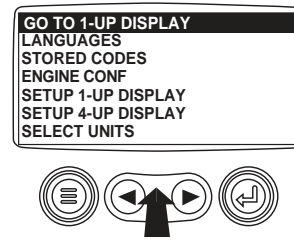

3. Touching the right arrow button will scroll down to reveal the last items of "Main Menu" screen highlighting the next item down.

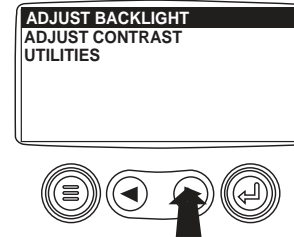

4. Touch the "Arrows" to scroll to the desired menu item or touch "Menu" to exit the Main menu and return to the engine parameter display.

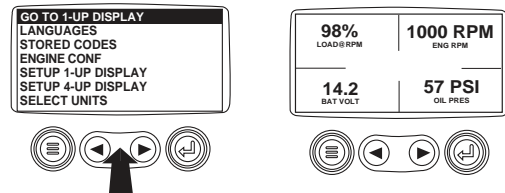

Selecting a Language

1. Starting at the main menu display use the "Arrows" to scroll to the "Language" menu and once highlighted touch the "Enter" button.

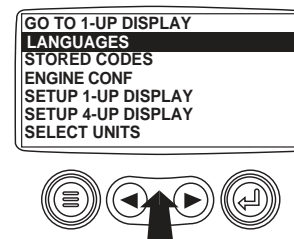

2. The language choices will be displayed. Use the "Arrow" buttons to scroll through the selections and touch "Enter" to make a selection.



- Now that you have selected the language, touch the “Menu” button to return to the main menu display.

Stored Fault Codes

- Starting at the main menu display use the “Arrows” to scroll to the “Language” menu and once highlighted touch the “Enter” button.

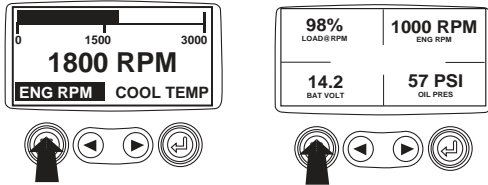

- The main menu will pop up on the display. Use the “Arrow Buttons” to scroll through the menu until the Stored Fault Codes is highlighted.

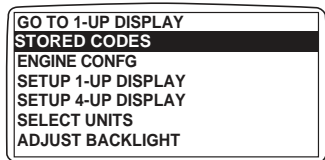

- Once the “Stored Fault Codes” menu item has been highlighted touch the “Enter Button” to view the “Stored Fault Codes” (when applicable, consult engine or transmission manufacturer for SAE J1939 supported parameters).

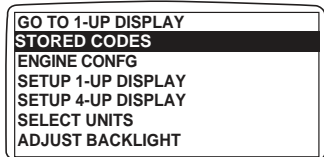

- If the word “MORE” appears above the “Arrow Buttons” there are more stored fault codes that may be viewed. Use the “Arrow Buttons” to scroll to the next Stored Diagnostic Code.

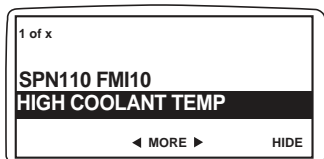

- Touch the “Menu Button” to return to the main menu.

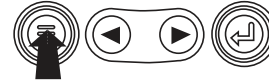
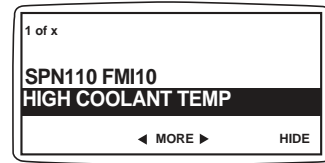

- Touch the “Menu Button” to exit the Main menu and return to the engine parameter display.

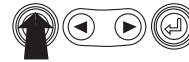
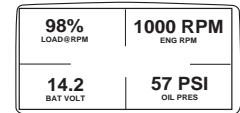
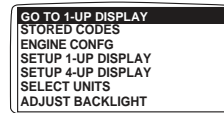

Engine Configuration Data

- Starting at the single or four engine parameter display touch the “Menu Button”.

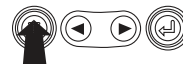
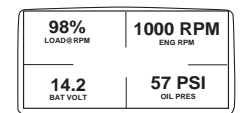
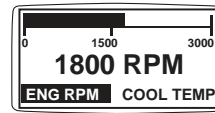

- The main menu will pop up on the display. Use the “Arrow Buttons” to scroll through the menu until the “Engine Configuration” is highlighted.

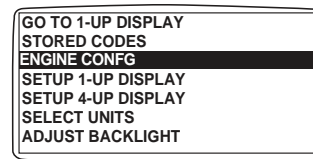

- Once the “Engine Configuration” menu item has been highlighted touch the “Enter Button” to view the engine configuration data.

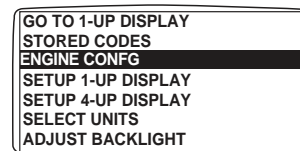

- Use the “Arrow Buttons” to scroll through the engine configuration data.

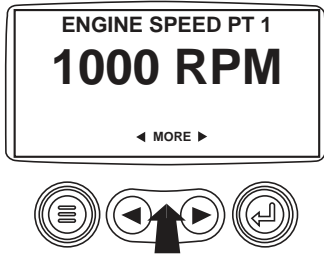

- Touch the “Menu Button” to return to the main menu.

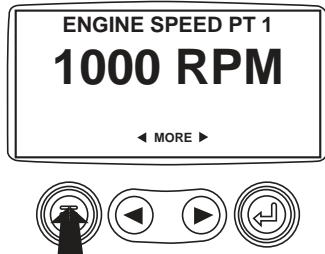

- Touch the “Menu Button” to exit the Main menu and return to the engine parameter display.

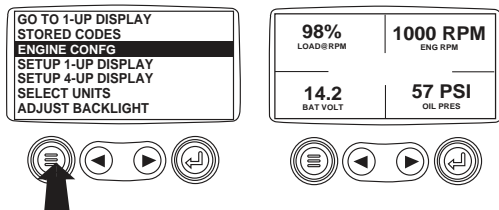

Faults and Warnings
Auxiliary Gage Fault

- During normal operation the single or four parameter screen will be displayed.

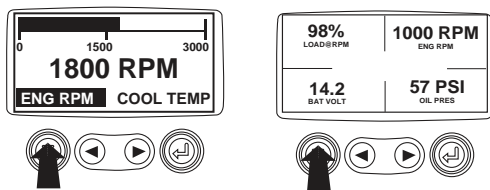

- The PVA Series of auxiliary gages can be attached to the PowerView. These auxiliary gages communicate with the Modbus master PowerView via a daisy-chained RS-485 port. If at any time during system initialization or normal operation an auxiliary gage should fail, the single or four parameter screen will be replaced with the “MLink Gage Fault” message.



- To acknowledge and “Hide” the fault and return to the single or four parameter display, touch the “Enter Button”



- The display will return to the single or four parameter screen.

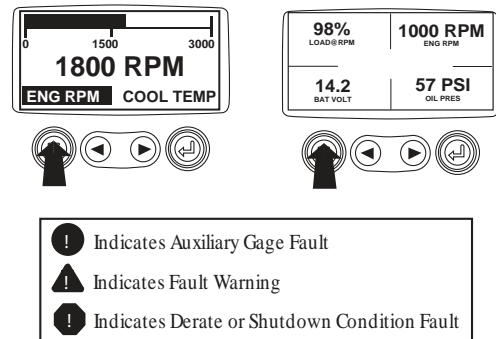

- Touching the “Enter Button” will re-display the hidden fault. Touching the “Enter Button” once again will hide the fault and return the screen to the single or four parameter display.



NOTE

The fault can only be cleared by correcting the cause of the fault condition.

Active Fault Codes

1. During normal operation the single or four parameter screen will be displayed.

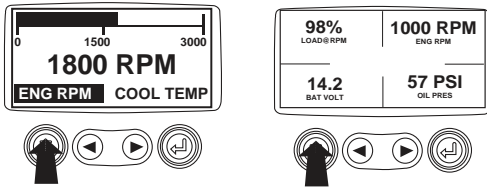

2. When the PowerView receives a fault code from an engine control unit the single or four parameter screen will be replaced with the "Active Fault Codes" message.

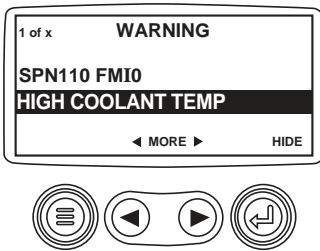

3. If the word "MORE" appears above the "Arrow Buttons" there are more active fault codes that may be viewed. Use the "Arrow Buttons" to scroll to the next "Active Fault Code"

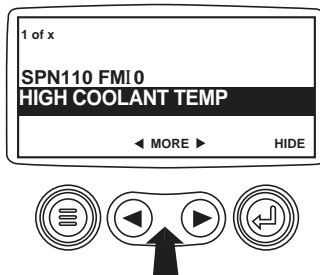

4. To acknowledge and "Hide" the fault and return to the single or four parameter display touch the "Enter Button".

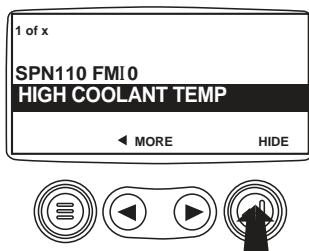

5. The display will return to the single or four parameter display, but the display will contain the "Active Fault" warning icon. Touching the "Enter Button" will re-display the hidden fault.

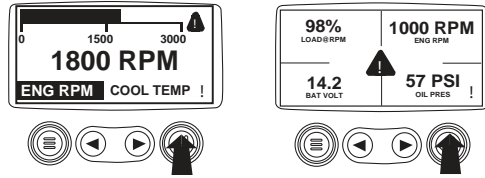

6. Touching the "Enter Button" once again will hide the fault and return the screen to the single or four parameter display.

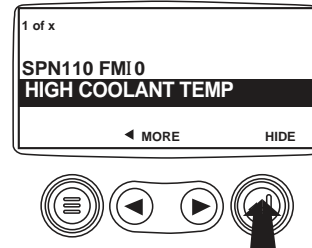

7. The Single or Four parameter screen will display the fault icon until the fault condition is corrected. NOTE: Ignoring active fault codes could result in severe engine damage.

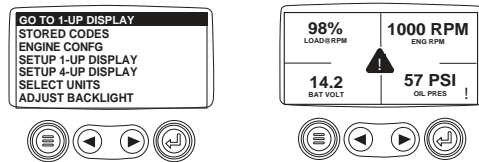

Shutdown Codes

1. During normal operation the single or four parameter screen will be displayed.

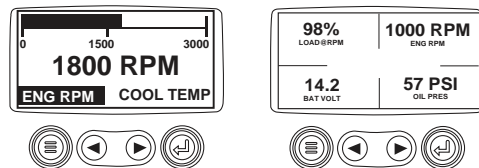

2. When the PowerView receives a severe fault code from an engine control unit the single or four parameter screen will be replaced with the "Shutdown!" message.

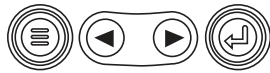
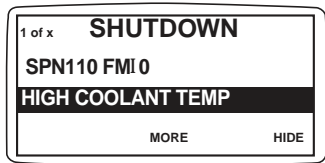

- To acknowledge and "Hide" the fault and return to the single or four parameter display touch the "Enter Button".

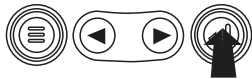
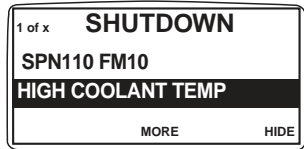

- The display will return to the single or four parameter display, but the display will contain the "Shut Down" icon. Touching the "Enter Button" will re-display the hidden fault.



- Touching the "Enter Button" once again will hide the fault and return the screen to the single or four parameter display.

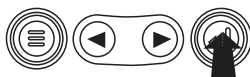
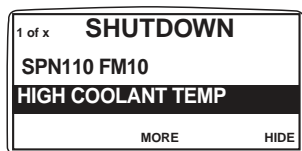

- The Single or Four parameter screen will display the fault icon until the fault condition is corrected. NOTE: Ignoring active fault codes could result in severe engine damage.

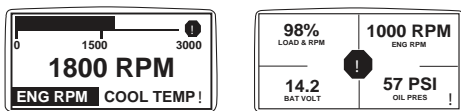

Back Light Adjustment

- Starting at the single or four engine parameter display touch the "Menu Button".

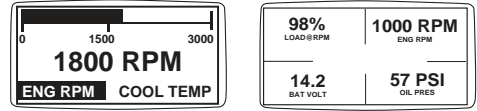

- The main menu will pop up on the display. Use the "Arrow Buttons" to scroll through the menu until the "Adjust Backlight" is highlighted.

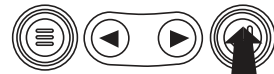
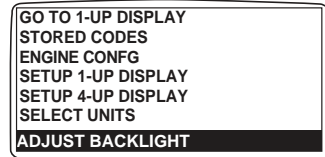

- Once the "Adjust Backlight" menu item has been highlighted touch the "Enter Button" to activate the "Adjust Backlight" function.

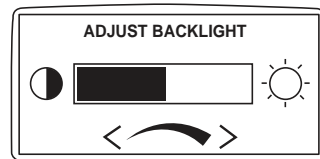

- Use the "Arrow Buttons" to select the desired backlight intensity.

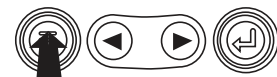
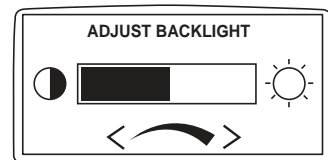

- Touch the "Menu Button" to return to the main menu.

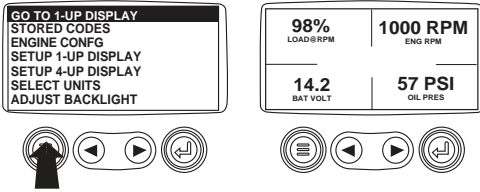

6. Touch the “Menu Button” to exit the Main menu and return to the engine parameter display.

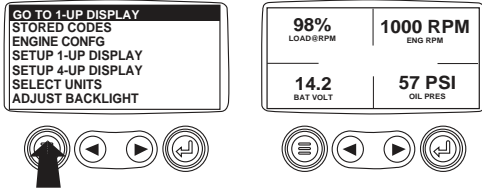

Contrast Adjustment

1. Starting at the single or four engine parameter display, touch the Menu Button”.

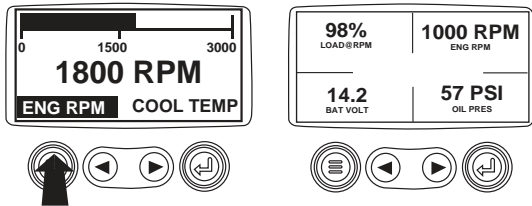

2. The main menu will pop up on the display. Use the “Arrow Buttons” to scroll through the menu until “Adjust Contrast” is highlighted.

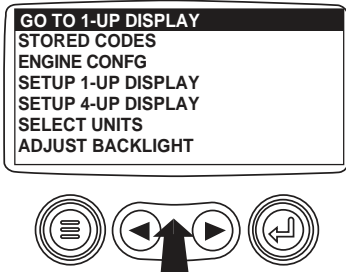

3. Once the “Adjust Contrast” menu item has been highlighted touch the “Enter Button” to activate the “Adjust Contrast” function.

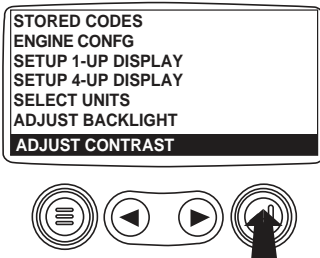

4. Use the “Arrow Buttons” to select the desired contrast intensity.

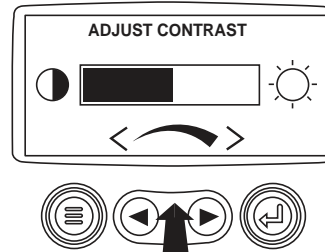

5. Touch the “Menu Button” to return to the main menu.

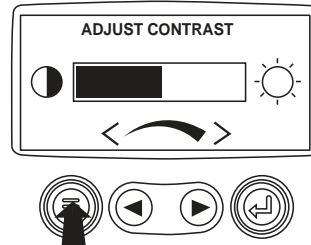

6. Touch the “Menu Button” to exit the Main menu and return to the engine parameter display.

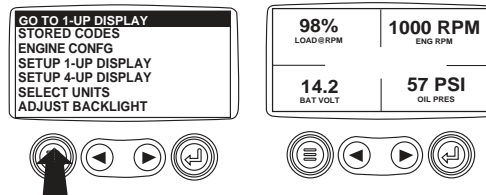

Select Units

1. Starting at the single or four engine parameter display touch the “Menu Button”.

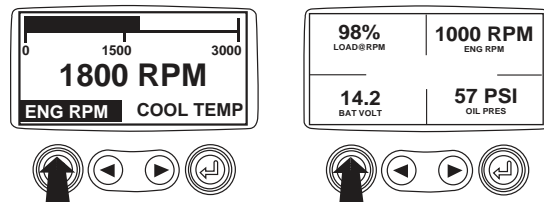

2. The main menu will pop up on the display. Use the arrow buttons to scroll through the menu until the “Select Units” is highlighted.

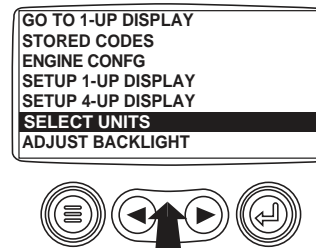

- Once the “Select Units” menu item has been highlighted touch the “Enter Button” to access the “Select Units” function.

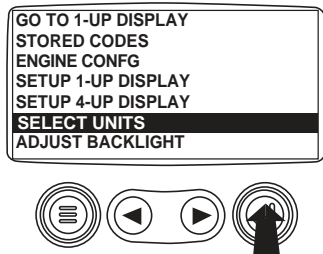

- Use the arrows to highlight the desired units. “English” for Imperial units i.e. PSI, °F or Metric kPa, Metric Bar for IS units i.e. kPa, Bar, °C.

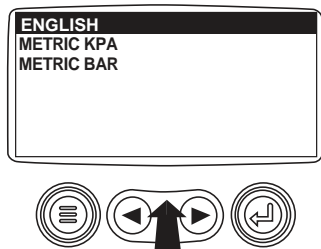

- Touch the “Enter Button” to select the highlighted units.

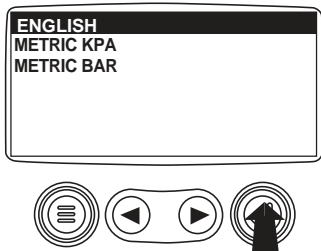

- Touch the “Menu Button” to return to the “Main Menu”.

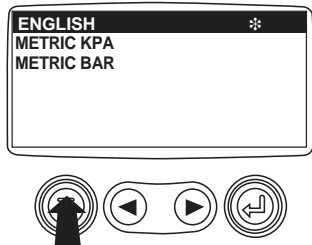

- Touch the “Menu Button” to exit the Main menu and return to the engine parameter display.

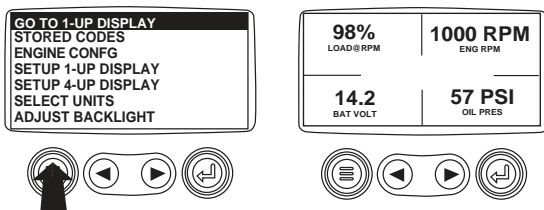

Setup 1-Up Display

- Starting at the single engine parameter display, touch the “Menu Button”.

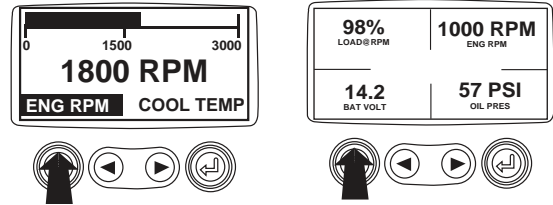

- The main menu will pop up on the display. Use the “Arrow Buttons” to scroll through the menu until the “Setup 1-up Display” is highlighted.

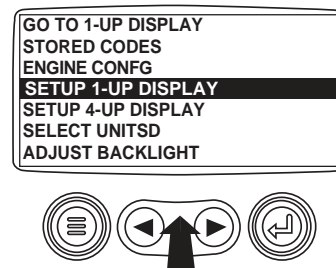

- Once the “Setup 1-up Display” menu item has been highlighted touch the “Enter Button” to access the “set up 1-up display” function.

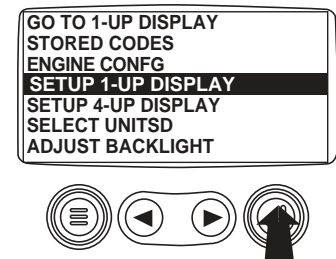

- Three options are available for modification of the 1-Up display.

- Use Defaults – This option contains a set of engine parameters: Engine Hours, Engine RPM, System Voltage, Battery Voltage, % Engine Load at Current RPM, Coolant Temperature, Oil Pressure.
- Custom Setup – This option allows for the modification of what parameter, the number of parameters, and the order in which the parameters are being displayed.
- Automatic Scan – Selecting the scan function will cause the 1-Up Display to scroll through the selected set of parameters one at a time, momentarily pausing at each.

5. **Use Defaults** - To select "Use Defaults" use the arrow buttons to scroll to and highlight "Use Defaults" in the menu display.

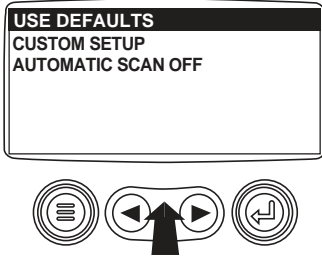

6. Touch the "Enter Button" to activate the "Use Defaults" function.

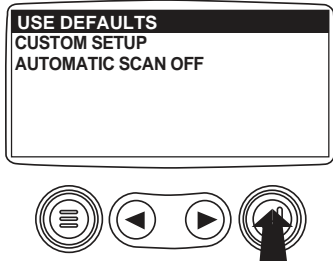

7. A message indicating the "Single Engine" parameter display parameters are reset to the factory defaults will be displayed, then the display will return to the "Custom Setup" menu.

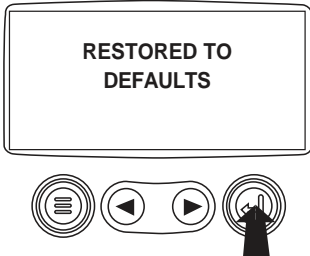

8. **Custom Setup** - To perform a custom setup of the 1-Up Display, use the arrow buttons to scroll to and highlight "Custom Setup" on the display.

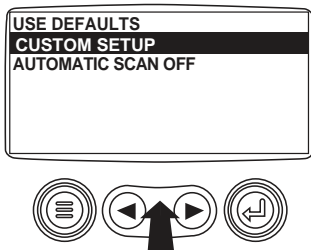

9. Touching the "Enter Button" will display a list of engine parameters.

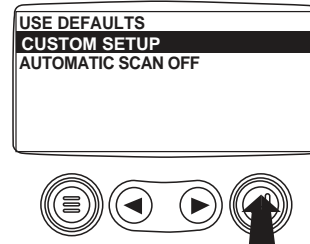

10. Use the "Arrow Buttons" to scroll to and highlight a selected parameter (parameter with a # symbol to right of it).

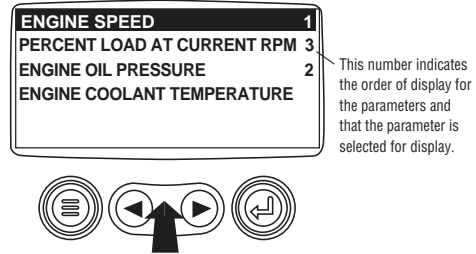

11. Touch the "Enter Button" to deselect the selected parameter removing it from the list of parameters being displayed on the 1-up display.

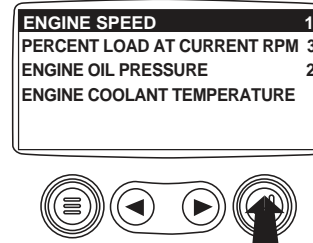

12. Use the "Arrow Buttons" to scroll and highlight the desired parameter that has not been selected for display.

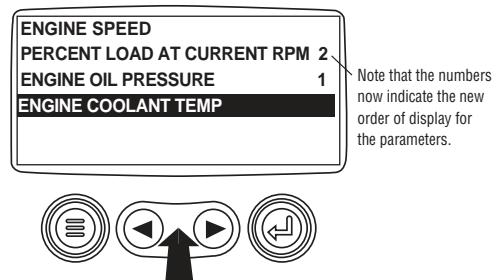

13. Touch the "Enter button" to select the highlighted parameter for inclusion in the Single Engine Parameter Display.

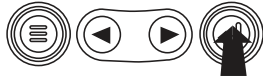
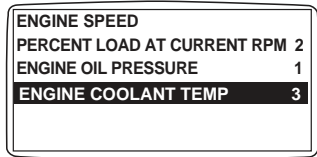

- Continue to scroll and select additional parameters for the custom 1-Up Display. Touch the "Menu button" at any time to return to the "Custom Setup" menu.
- Automatic Scan** - Selecting the scan function will cause the 1-Up Display to scroll through the selected set of parameters one at a time. Use the "Arrow Buttons" to scroll to the "Automatic Scan" function.

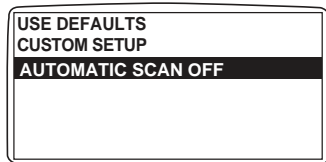

- Touching the "Enter Button" toggles the "Automatic Scan" function on.

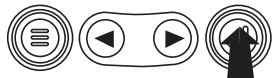
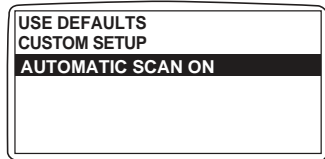

- Touching the "Enter Button" again toggles the "Automatic Scan" function off.

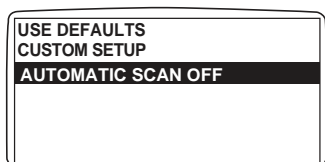

- Once the "Use Defaults", "Custom Setup" and "Automatic Scan" functions have been set touch the "Menu Button" to return to the main menu.

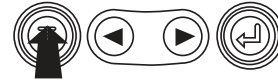
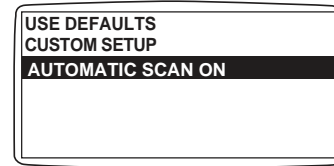

- Touch the "Menu Button" to exit the Main menu and return to the engine parameter display.

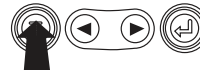
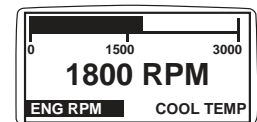
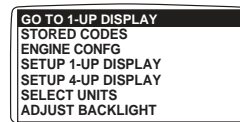

Setup 4-Up Display

- From the single or four engine parameter display touch the "Menu Button".

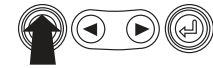
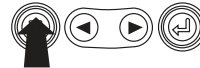
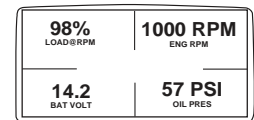
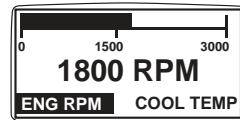

- The main menu will pop up on the display. Use the "Arrow Buttons" to scroll through the menu until the "Setup 4-Up Display" is highlighted.

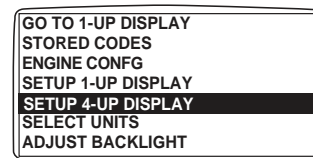

- Once the "Setup 4-Up Display" menu item has been highlighted touch the "Enter Button" to activate the "Setup 4-Up Display" menu.

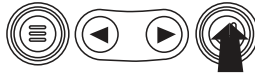
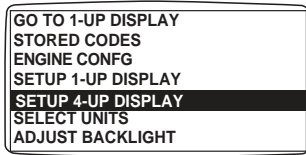

4. Touch the “Enter Button” to activate the “Use Defaults” function. This action will reset the unit to the factory default.

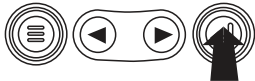
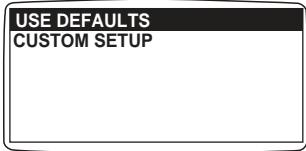

5. The “Use Defaults” screen will be displayed during the resetting period then will automatically return to the “Setup 4-Up Display” menu.



6. Select the “4-Up Custom Setup” from the “4-Up Setup” menu.

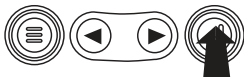
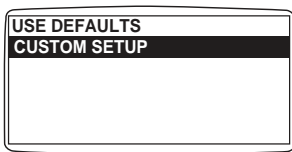

7. The quadrant with the backlit parameter value is the current selected parameter. Use the “Arrow Buttons” to highlight the parameter value in the quadrant you wish to place a new parameter.

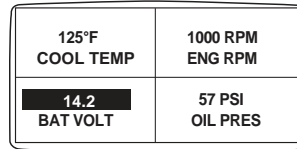

8. Touch the “Enter Button” and a list of parameters will appear.

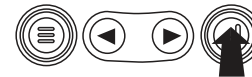
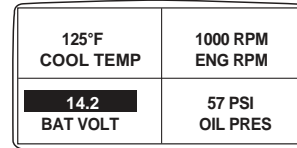

9. The parameter that is highlighted is the selected parameter for the screen. Use the “Arrow Buttons” to highlight the new parameter to be placed in the quadrant selected in the previous screen.

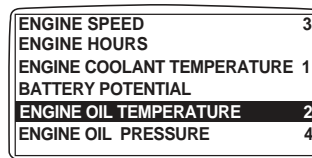

The number to the right of the parameter indicates the quadrant in which it is displayed.
 1. = Upper Left Quadrant
 2. = Lower Left Quadrant
 3. = Upper Right Quadrant
 4. = Lower Right Quadrant



10. Touch the “Enter Button” to change the selected parameter in the quadrant to the new parameter.

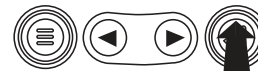
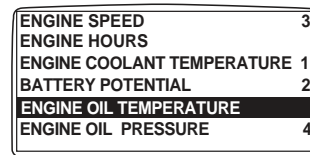

11. Use the “Menu Button” to return to the “4-UP Custom Setup” screen.

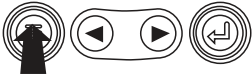
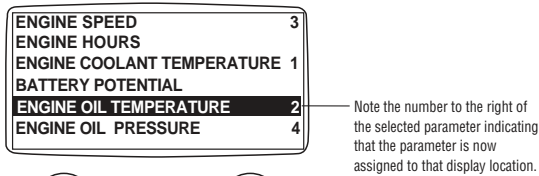

- The parameter in the selected quadrant has changed to the parameter selected in the previous screen.

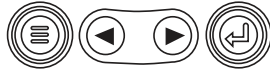
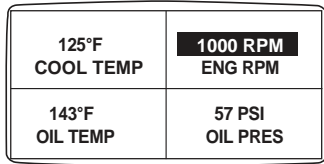

- Repeat the parameter selection process until all spaces are filled.

- Touch the "Menu Button" to return to the main menu.

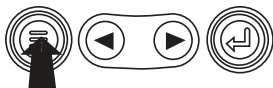
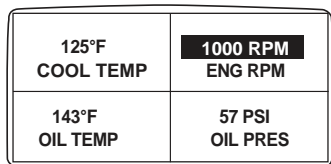

- Touch the "Menu Button" to exit the Main menu and return to the engine parameter display.

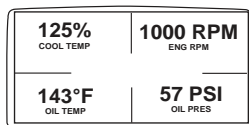
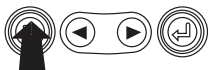
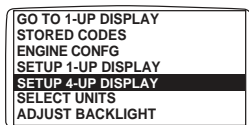

Utilities (Information and Troubleshooting)

- Starting at the single or four engine parameter display, touch the "Menu button".

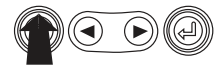
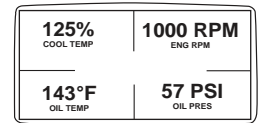
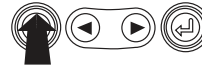
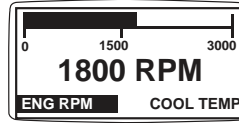

- The main menu will be displayed. Use the "Arrow buttons" to scroll through the menu until the "Utilities" is highlighted.

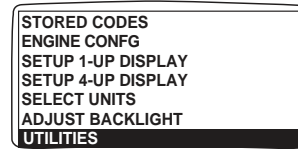

- Once the "Utilities" menu item has been highlighted, touch the "Enter Button" to activate the "Utilities" functions.

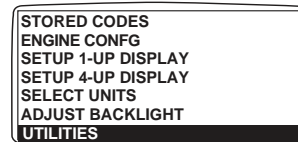

- Touch "Select" to enter the "Gage Data" display. When "Gage Data" is selected the PowerView will communicate with the analog gages at a fixed rate of 38.4 Kilo Baud, 8 data bits, no parity check, 1 stop bits, half duplex.

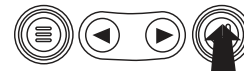
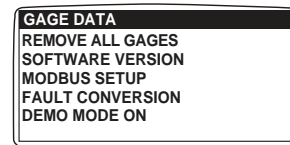

- Use the "Arrow buttons" to scroll through the items or touch "Menu" to return to the "Utilities" menu.

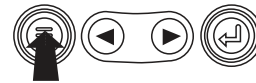
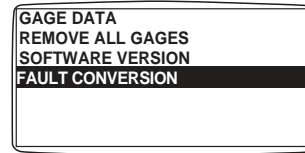
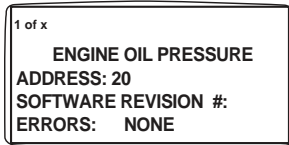

- 6. Touch "Menu Button" to return to the "Utilities" menu.

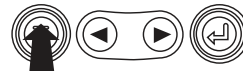
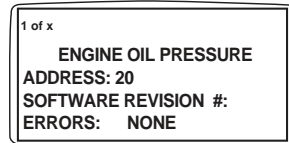

- 10. Use the "Arrows" to scroll and highlight the version then touch "Select" and an asterisks appears to the right of the selection.

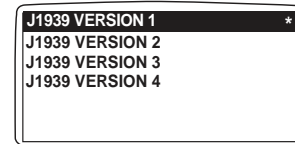

- 7. Use the "Arrows" to highlight "Remove All Gages". Touch "Select" to clear gage data from memory. It takes a moment to clear all gages.

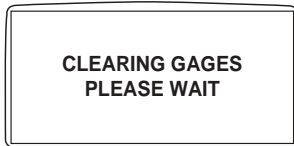

NOTE

There are four (4) different methods for converting fault codes.

The PowerView always looks for J1939 Version 4 and can be set to use one of the 3 other J1939 versions. Most engine ECU's use Version 4, therefore in most cases adjustment of this menu option will not be required.

- 8. When the gage data has cleared, the display automatically returns to the "Utilities" menu. Scroll to "Software Version". Touch "Select" to view the software version currently in the PowerView.

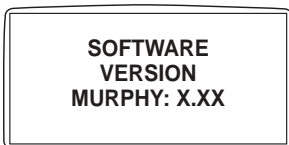

Upon receiving an unrecognizable fault, change to a different J1939 Version. If the fault SPN does not change when the version is changed, the ECU generating the fault is using Fault Conversion method 4. If the SPN number does change but is still unrecognizable, try changing to another J1939 Version not yet used and continue to check the SPN number.

- 9. Touch "Menu" to return to "Utilities". Highlight "Fault Conversion" using the "Arrows". Touch "Select" to enter the Fault conversion menu.

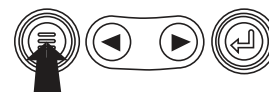
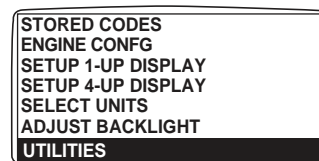

- 11. Touch the "Menu" button to return to "Utilities" menu. Touch the "Menu" button again to return to the "Main" menu.

MODBUS Setup

- Starting at the single or four engine parameter display, touch the “Menu button”.

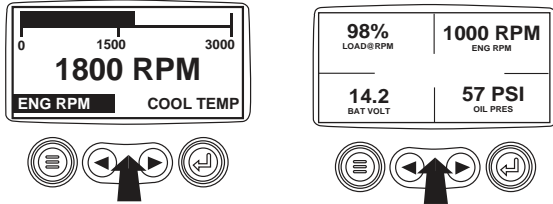

- The main menu will be displayed. Use the “Arrow buttons” to scroll through the menu until the “Utilities” is highlighted, then touch “Enter”.

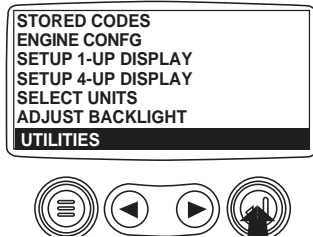

- Once in the “Utilities” menu use the “Arrows” to scroll through the menu until the “Modbus Setup” menu is highlighted, then touch “Enter”.

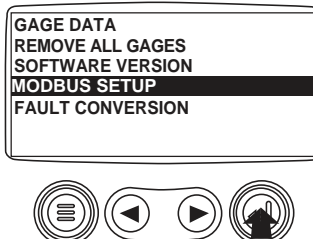

- Use the “Arrows” to scroll down to and highlight either the “Slave Active or Master Active” modes. Touch the “Enter” button to toggle between master and slave.

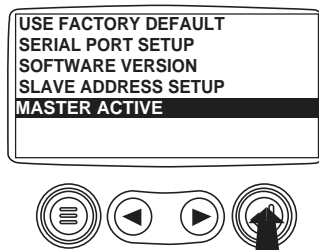

- Use the “Arrows” to scroll to the “Serial Port” menu to highlight it, then touch “Enter”.

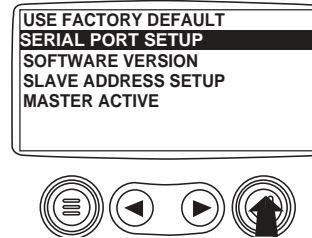

- Use the “Arrow” button to scroll to each selection to configure the MODBUS values for your application.

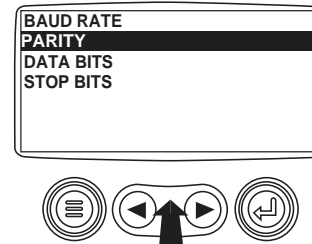

Error Messages

PowerView Error Messages		
SPN	FMI	Description
28	3	% ACCEL POS3 VOLT ABOVE NORM OR SHORT HIGH
28	4	% ACCEL POS3 VOLT BELOW NORM OR SHORT LOW
29	3	% ACCEL POS2 VOLT ABOVE NORM OR SHORT HIGH
29	4	% ACCEL POS2 VOLT BELOW NORM OR SHORT LOW
91	3	ACCEL PEDAL POS VOLT ABOVE NORM OR SHORT HIGH
91	4	ACCEL PEDAL POS VOLT BELOW NORMAL OR SHORT LOW
91	9	ACCEL PEDAL POS A VALID THROTTLE MSG NOT RCVD
91	14	ACCEL PEDAL POS THROTTLE SIG VOLT OUT OF RANGE
94	1	FUEL DELIVERY PRESSURE VERY LOW
94	3	FUEL RAIL PRESSURE VOLTAGE OUT OF RANGE HIGH
94	4	FUEL RAIL PRESSURE VOLTAGE OUT OF RANGE LOW
94	10	FUEL DELIVERY PRESSURE DROPPING TO FAST
94	13	FUEL DELIVERY PRESSURE OUT OF CALIBRATION
94	16	FUEL DELIVERY PRESSURE HIGH
94	17	NO RAIL FUEL PRESSURE
94	18	FUEL DELIVERY PRESSURE LOW
97	0	WATER IN FUEL DETECTED
97	3	WATER IN FUEL INDICATOR VOLTAGE OUT OF RANGE HIGH
97	4	WATER IN FUEL INDICATOR VOLTAGE OUT OF RANGE LOW
97	16	WATER IN FUEL DETECTED
97	31	WATER IN FUEL DETECTED
100	1	ENGINE OIL PRESSURE LOW
100	3	ENGINE OIL PRESS VOLT ABOVE NORM OR SHORT HIGH SOURCE
100	4	ENGINE OIL PRESS VOLT BELOW NORM OR SHORT LOW SOURCE
100	16	ENGINE OIL PRESSURE READING INCORRECT
100	18	ENGINE OIL PRESS LOW
105	0	INTAKE MAN1 AIR TEMP HIGH
105	3	INTAKE MAN1 TEMP VOLT ABOVE NORM OR SHORT HIGH SOURCE
105	4	INTAKE MAN1 TEMP VOLT BELOW NORM OR SHORT LOW SOURCE
105	16	INTAKE MAN1 AIR TEMP HIGH
107	0	AIR FILT DIFF PRESS PLUGGED AIR FILTER DETECTED
107	31	AIR FILT DIFF PRESS PLUGGED AIR FILTER DETECTED
110	0	ENG COOL TEMP HIGH
110	3	ENG COOL TEMP VOLT ABOVE NORM OR SHORT HIGH SOURCE
110	4	ENG COOL TEMP VOLT BELOW NORM OR SHORT LOW SOURCE
110	15	ENG COOL TEMP HIGH
110	16	ENG COOL TEMP HIGH
111	1	LOW COOLANT LEVEL
158	2	KEYSWITCH INTERMITTENT
158	17	KEYSWITCH CIRCUIT PROBLEM
174	0	FUEL TEMP HIGH

118A

Error Messages - Continued

PowerView Error Messages - continued		
SPN	FMI	Description
190	0	ENGINE OVERSPEED
190	2	ENG SPD DATA ERRATIC, INTERMITTENT OR INCORRECT
190	3	ENG SPD VOLT ABOVE NORMAL OR SHORT HIGH
190	4	ENG SPD VOLT BELOW NORMAL OR SHORT LOW
190	5	ENG SPD CIRCUIT IS OPEN
190	16	ENGINE OVERSPEED
611	3	INJ WIRING SHORTED TO BATTERY
611	4	INJ WIRING SHORTED TO GROUND
620	3	SENSOR VOLT1 (+5VDC) ABOVE NORMAL OR SHORT HIGH
620	4	SENSOR VOLT1 (+5VDC) BELOW NORMAL OR SHORT LOW
627	1	POWER SUPPLY LOW VOLT TO INJECTORS
627	4	POWER SUPPLY INTERRUPTION
629	13	REPROGRAM CONTROLLER ECU PROBLEM
629	19	ECU NOT RECEIVING MSG FROM PUMP
632	2	FUEL SHUTOFF VALVE ERR DETECTED
632	5	FUEL SHUTOFF VALVE NON-FUNCTIONAL
632	11	FUEL SHUTOFF VALVE SOLENOID CKT OPEN OR SHORTED
636	2	ENG POS SENSOR TIMING SIGNAL ERROR
636	8	ENG POS SENSOR TIMING SIGNAL ERROR
636	10	ENG POS SENSOR TIMING SIGNAL ERROR
637	2	TIMING (CRANK) SENSOR TIMING SIGNAL ERROR
637	7	TIMING (CRANK) SENSOR TIMING SIGNAL ERROR
637	8	TIMING (CRANK) SENSOR TIMING SIGNAL ERROR
637	10	TIMING (CRANK) SENSOR TIMING SIGNAL ERROR
639	13	CAN BUS FAILURE
651	5	INJ CYLINDER1 CURRENT LESS THAN EXPECTED
651	6	INJ CYLINDER1 CURRENT INCREASE TOO RAPIDLY
651	7	INJ CYLINDER1 FUEL FLOW LOWER THAN EXPECTED
652	5	INJ CYLINDER2 CURRENT LESS THAN EXPECTED
652	6	INJ CYLINDER2 CURRENT INCREASES TOO RAPIDLY
652	7	INJ CYLINDER2 FUEL FLOW LOWER THAN EXPECTED
653	5	INJ CYLINDER3 CURRENT LESS THAN EXPECTED
653	6	INJ CYLINDER3 CURRENT INCREASES TOO RAPIDLY
653	7	INJ CYLINDER3 FUEL FLOW LOWER THEN EXPECTED
654	5	INJ CYLINDER4 CURRENT LESS THAN EXPECTED
654	6	INJ CYLINDER4 CURRENT INCREASES TOO RAPIDLY
654	7	INJ CYLINDER4 FUEL FLOW LOWER THAN EXPECTED
655	5	INJ CYLINDER5 CURRENT LESS THAN EXPECTED
655	6	INJ CYLINDER5 CURRENT INCREASES TOO RAPIDLY
655	7	INJ CYLINDER5 FUEL FLOW LOWER THAN EXPECTED
656	5	INJ CYLINDER6 CURRENT LESS THAN EXPECTED
656	6	INJ CYLINDER6 CURRENT INCREASES TOO RAPIDLY
656	7	INJ CYLINDER6 FUEL FLOW LOWER THAN EXPECTED
676	3	GLOW PLUG RELAY STUCK ON
676	5	GLOW PLUG RELAY WILL NOT TURN ON
729	3	INLET AIR HEATER DRIVER1 STUCK ON
729	5	INLET AIR HEATER DRIVER1 WILL NOT TURN ON

118A-2

Error Messages - Continued

PowerView Error Messages - continued		
SPN	FMI	Description
833	2	RACK POSITION SENSOR ERROR
833	3	RACK POSITION SENSOR VOLT ABOVE NORMAL
833	4	RACK POSITION SENOR VOLT BELOW NORMAL
834	2	RACK ACTUATOR ERROR BLEED AIR IN FUEL SYSTEM
834	3	RACK ACTUATOR CKT VOLT ABOVE NORMAL
834	5	RACK ACTUATOR CKT OPEN
834	6	RACK ACTUATOR CKT GROUNDED
834	7	RACK ACTUATOR POSITION ERROR
970	2	EXT AUX ENG SHUTDOWN SWITCH INTERMITTENT
970	11	EXT ENG PROTECTION SHUTDOWN ACTIVE
970	31	EXT AUX ENG SHUTDOWN SWITCH ACTIVE
971	31	ENG DERATE SWITCH ACTIVATED
1041	2	START SIGNAL MISSING
1041	3	START SIGNAL ALWAYS ACTIVE
1076	0	FUEL INJ PUMP CONT VALVE ERROR
1076	1	FUEL INJ PUMP CONT VALVE ERROR
1076	2	FUEL INJ PUMP CONT VALVE ERROR
1076	3	FUEL INJ PUMP CONT VALVE ERROR
1076	5	FUEL INJ PUMP CONT VALVE ERROR
1076	6	FUEL INJ PUMP CONT VALVE ERROR
1076	7	FUEL INJ PUMP CONT VALVE ERROR
1076	10	FUEL INJ PUMP CONT VALVE ERROR
1076	13	FUEL INJ PUMP CONT VALVE ERROR
1077	7	FUEL INJ PUMP ERROR
1077	11	FUEL INJ PUMP CONT VP44 INPUT VOLT OUT OF RANGE
1077	12	FUEL INJ PUMP CONT VP44 SELF TEST ERROR
1077	19	FUEL INJ PUMP CONT VP44 DETECTED CAN BUS FAILURE
1077	31	FUEL INJ PUMP CONT POWER DERATED
1078	7	FUEL INJ PUMP SPD/POS SENSOR ERROR
1078	11	FUEL INJ PUMP SPD/POS SENSOR ERROR
1078	31	FUEL INJ PUMP SPD/POS VP44 UNABLE TO ACHIEVE TIMING
1079	3	SENSOR VOLT1 (+5VDC) ABOVE NORM OR SHORT HIGH
1079	4	SENSOR VOLT1 (+5VDC) BELOW NORM OR SHORT LOW
1080	3	SENSOR VOLT2 (+5VDC) ABOVE NORM OR SHORT HIGH
1080	4	SENSOR VOLT2 (+5VDC) BELOW NORM OR SHORT LOW
1109	31	ENG PROT SYSTEM APPROACHING SHUTDOWN
1110	31	ENG PROT SYSTEM SHUT ENG DOWN
1347	5	FUEL PUMP ASSY 1 CKT OPEN SHORTED GROUND OR OVLOAD
1347	7	FUEL PUMP ASSY 1 RAIL PRESSURE CONT MISMATCH
1347	10	FUEL PUMP ASSY 1 LOW FUEL FLOW
1348	5	FUEL PUMP ASSY 2 CKT OPEN SHORTED GROUND OR OVLOAD
1348	10	FUEL PUMP ASSY 2 LOW FUEL FLOW
1485	2	ECU MAIN RELAY PUMP POWER RELAY FAULT
1569	31	ENG PROT TORQ FUEL DERATE LIMIT CONDITION EXIST
2000	6	FUEL INJECTION PUMP CONT VALVE ERROR
2000	13	SECURITY VIOLATION PROPER CONT NOT INSTALLED

118A-3

5.1-4 Replace Engine Oil and Filter

Maintaining the engine components is essential to good performance and service life of the telehandler.

Periodic replacement of the engine oil and filter is essential to good engine performance.

NOTE

Perform this operation after warming the engine to normal operating temperature.



CAUTION

Beware of hot engine components. Contact with hot engine components may cause severe burns.



CAUTION

When draining hot oil, there is a risk of scalding. Do not let used oil run into the soil, rather collect it in a container. Dispose of this in accordance with environmental regulations.

1. Ensure telehandler is on a firm level surface.
2. Allow engine to warm up.
3. Locate engine side door behind operator's cab.
4. Remove locking pins and lift up engine side doors so that engine components are accessible.
5. Place suitable container under engine.
6. Remove oil drain plug and allow all engine oil to drain into container.
7. Install oil drain plug with new seal ring and tighten firmly.

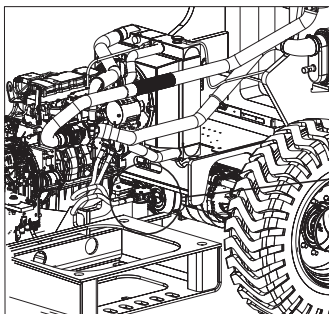

8. Remove oil filter and catch any escaping oil.
9. Clean inside the filter head.
10. Add clean engine oil to oil filter.
11. Apply a thin layer of engine oil to the new oil filter gasket.
12. Install filter and tighten it by hand.
13. Clean up any oil that may have spilled during this procedure.
14. Refill engine with new oil as per specifications (refer to [Table 2.2](#)).
15. Start engine and allow it to run for 30 seconds then stop the engine.
16. Check for oil leakage.
17. Check engine oil level on dipstick and add oil if needed.
18. Close engine side doors and reinstall locking pins.

NOTE

Refer to your national/local regulations on how to dispose of used filter and oil.

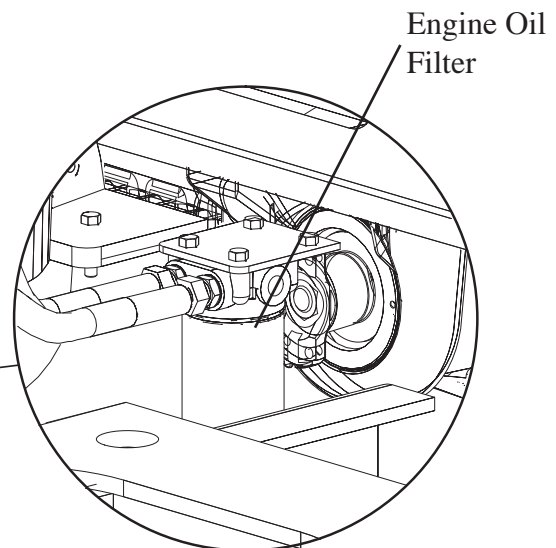

5.1-5 Check Engine Air Filter

Check the air cleaner vaccuator valve if applicable. Squeeze the valve lips and remove any dirt or dust. It should expel dust and dirt continuously when the engine is running.

Inspect the condition of both the primary and safety elements and replace if required.



WARNING

Do not remove the inner safety filter unless it is damaged or dirty.

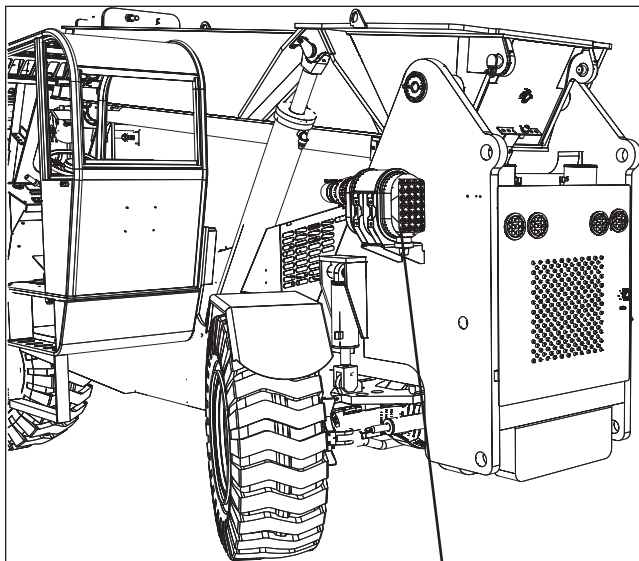

Air Filter

5.1-6 Replace Fuel Filter

1. Ensure telehandler is on a firm level surface.
2. Remove locking pins on engine side doors and lift them up so that engine components are accessible.
3. Use the filter drain valve to drain fuel out of the filter for approximately 5 seconds.
4. Disconnect the water-in-fuel sensor from the wiring harness
5. Remove fuel filter and catch any escaping fuel.
6. Clean any dirt from filter carrier sealing surface.

7. Apply a thin layer of oil or diesel fuel to rubber gasket of new fuel filter.

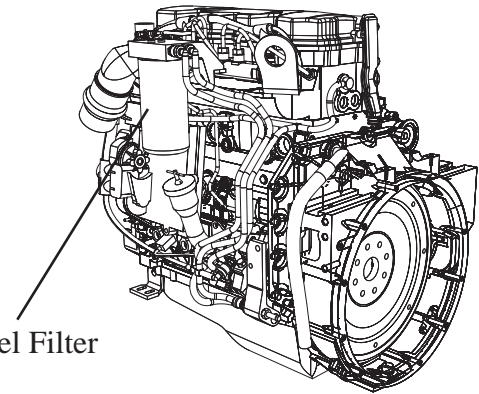

Fuel Filter

8. Install fuel filter and tighten it by hand.
9. Connect the water-in-fuel sensor to the wiring harness.
10. Bleed the fuel lines by loosening the bleed screws.
11. Operate the hand lever until the fuel flowing from the fitting is free of air.
12. Tighten the bleed screws.
13. Clean up any fuel that may have spilled during this procedure.
14. Close engine side door and reinstall locking pins.

NOTE

Refer to your national/local regulations on how to dispose of used filter and oil.

5.1-7 Check Fan Drive Belt

Remove the drive belt and check that the automatic tensioner turns freely:

- With no play on bearing.
- Spring in tensioner hasn't become weak or broken.

Transmission

5.1-8 Check Transmission Filter Breather

The transmission and dipstick are accessed underneath the two transmission cover plates at the transmission mount.

Clean the transmission breather and surrounding area.

5.1-9 Change Transmission Fluid and Filter



WARNING

Ensure the following:

- Telehandler is parked on level ground.
- Engine is turned off.
- Parking brake on
- Wheels are blocked

Raise the boom high enough to allow access and lock out the ignition switch.

1. Remove bolts from two transmission cover plates.
2. Remove transmission cover plates so that Transmission components are accessible.
3. Place a suitable container under transmission.
4. Remove the transmission drain plug and drain the oil.
5. Remove the sump screen and clean with varsol and compressed air.
6. Replace the sump screen gasket.
7. Install the sump screen and replace the oil drain plug
8. Replace the Transmission oil filter.
9. Refill the transmission with the correct fluid and check the level on the dipstick "Full". (refer to [Table 2.2](#))
10. Check for oil leakage
11. Start the engine and check oil level with the engine running.

12. Add oil as needed to fill up to the required level.
13. Install transmission cover plates and tighten bolts.

NOTE

Refer to your national/local regulations on how to dispose of used filter and oil.

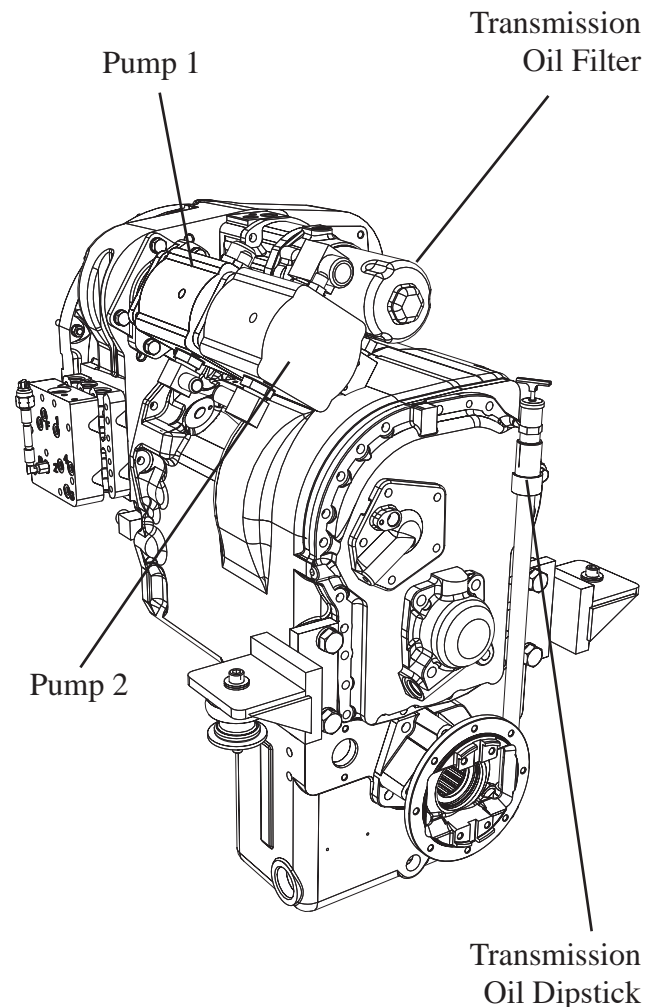

T32000 Transmission

Hydraulic System

5.2-1 Check Hydraulic Oil

Maintaining the hydraulic components and hydraulic oil at the proper level are essential to good performance and service life of the telehandler.

The telehandler must be on level ground and all cylinders retracted when checking oil level.

Refer to oil sight gauge on side of tank to check that the hydraulic fluid is within 4 inches below the top of the tank.

5.2-2 Change Hydraulic Tank Filter

NOTE

The filter does not need to be changed unless the service indicator is showing at the top of the filter. If the indicator is past the 3.4 green mark, change the filter. Should the indicator not be showing at 250 hours, check the unit. Check the service indicator daily. Change the return filter when the filter gauge indicates a dirty element.

1. Ensure telehandler is on a firm level surface, is in stowed position and engine is off.
2. Place suitable container under the hydraulic tank filter.
3. Remove oil filter and catch any escaping oil.
4. Clean inside the filter head.
5. Apply a thin layer of clean hydraulic oil to the new oil filter gasket.
6. Install filter and tighten firmly.
7. Clean up any oil that may have spilled during this procedure.
8. Start engine.
9. Check for leakage.

NOTE

Refer to your national/local regulations on how to dispose of used filter and oil.

5.2-3 Change Hydraulic Oil

1. Ensure telehandler is on a firm level surface and is in stowed position.
2. Allow hydraulic oil to warm up.
3. Turn off the engine.
4. Place suitable container under the hydraulic tank.
5. Remove oil drain plug and allow all hydraulic oil to drain into container.
6. Install oil drain plug with new seal ring and tighten firmly.
7. Refill hydraulic tank with new oil as per specifications. (refer to [Table 2.2](#) of this manual)
8. Check for leakage.
9. Clean up any oil that may have spilled during this procedure.
10. Check hydraulic oil level. (The hydraulic oil level should be at or slightly above the top mark on the sight gauge)

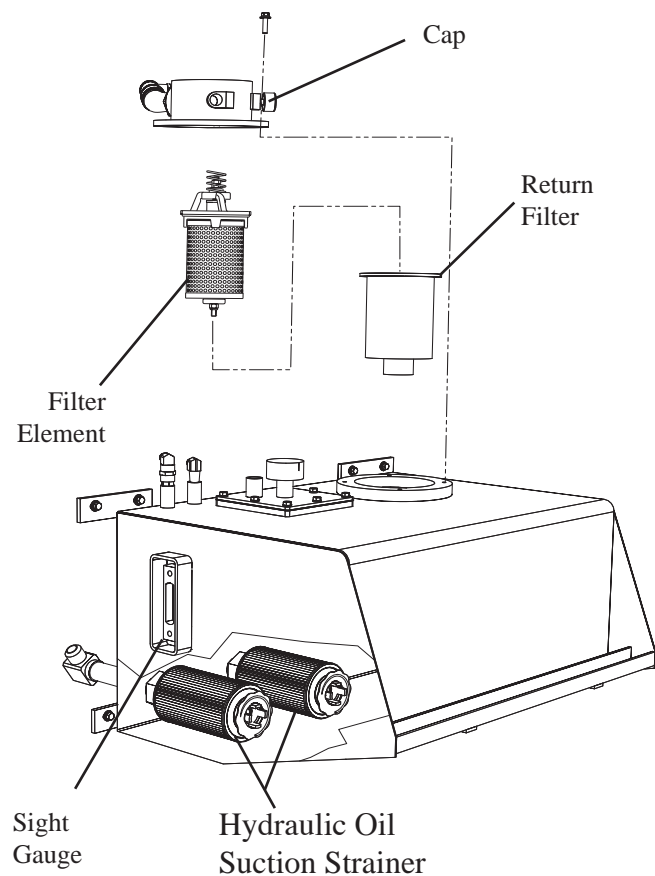

Hydraulic Oil Tank

NOTE

Refer to your national/local regulations on how to dispose of used filter and oil.

NOTE

Samples of hydraulic oil should be drawn from the reservoir and tested annually. These samples should be taken when the oil is warmed through normal operation of the system. The sample should be analyzed by a qualified lubrication specialist to determine if it is suitable for continued use. Oil change intervals will depend on the care used in keeping the oil clean, and the operating conditions. Dirt and/or moisture contamination will dictate that the oil should be changed more often. Under normal use and operating conditions, the hydraulic oil should be changed every two years. Refer to [Table 1.1](#) of this manual.

5.2-4 Bleeding Hydraulic Circuits**NOTE**

Whenever a hydraulic system is opened up, it is necessary to bleed or purge the air from the circuit that was opened.

Bleed Carriage Tilt Circuit

1. Tilt carriage to full forward position.
2. Raise boom fully while extending boom to keep carriage ahead of the front tires.
3. Tilt carriage to full backward position.
4. Lower and retract boom fully.
5. Tilt carriage forward as much as possible and raise boom to facilitate tilting carriage fully forward.
6. Repeat steps 1 through 5, five times
7. Check for air in the system by leveling forks and raising and lowering the boom several times while watching the forks to see if they stay level. If the forks do not stay level repeat above steps and re-check.

Bleed Boom Extend/Retract Circuit

- Fully extend and retract boom several times with boom level.

Bleed Boom Raise/Lower Circuit

- Fully raise and lower the boom several times. Ensure carriage remains ahead of the front tires.

Bleed Frame Level Circuit

- Tilt telehandler fully side to side several times with boom in a low position.

Bleed Auxiliary/Optional Circuits

- Operate function fully in both directions several times.

Bleed Outriggers Circuit

- Fully lower and raise outriggers several times.

Bleed Brake Circuit

1. With engine running depress and hold brake pedal. The hydraulic pump will constantly supply fluid; there is no need to pump the brake pedal.
2. Locate bleeder fittings on top of brake calipers at each wheel.
3. Starting with the fitting furthest from the pedal and working your way to the closest, slightly open each bleeder and close when hydraulic oil comes out clear.
4. Slowly loosen hose fitting at pressure switch shuttle valve on left frame rail. Tighten when fluid comes out clear.

Pressure Adjustment Procedures

NOTE

- All pressure adjustments are to be made at idle with telehandler on a level surface, park brake applied, and wheels chocked.
- Procedures require two persons; one to operate functions and another to check and adjust pressures.

5.3-1 Piston Pump Pressure

1. Park the machine on a firm level surface, apply the park brake and chock the wheels.
2. Raise and support the boom so the lifting attachment is at least 7 ft. up.
3. Install a pressure gauge (4000 psi minimum) to test ports TP4 and TP5.
4. Remove and plug load sense lines at both pumps.
5. With engine running check pressure reading; 500 psi for P1 (TP4), 550 psi for P2 (TP5).
6. Adjust as required at front adjuster by loosening jam nut and turning center screw clockwise to increase pressure and counter clockwise to decrease pressure.
7. When correct pressure is obtained, tighten jam nut.
8. Shut engine off and re-install load sense lines at both pumps.
9. With engine running hold the extend function in the retract position and check pressure reading; 3150 psi for P1 (TP4), 3200 psi for P2 (TP5).
10. Adjust as required at rear adjuster by loosening jam nut and turning center screw clockwise to increase pressure and counter-clockwise to decrease pressure.
11. When correct pressure is obtained, tighten jam nut.

5.3-2 Port Relief Pressure

1. Locate the main hydraulic valve mounted between the main frame rails, in the center of the frame.
2. Connect a pressure gauge (4000 psi minimum) to the test port TP6 located on the fitting at the P port of the main control valve.
3. Dead-end the desired function and note pressure reading on gauge.
4. Compare gauge reading to pressure settings chart (refer to [Table 2.5](#)) and adjust as necessary at the corresponding port relief valve. Adjust by loosening jam nut and turning center screw clockwise to increase pressure or counter-clockwise to decrease pressure. When correct pressure is achieved tighten jam nut and re-check pressure.

5.3-3 Priority Valve Relief Pressure

1. Locate the priority valve PRT1.
2. Connect a pressure gauge (3000 psi minimum) to test port TP5.
3. Turn the steering wheel to full lock position and note pressure reading on gauge.
4. Compare gauge reading to pressure settings chart (refer to [Table 2.5](#)) and adjust as necessary by loosening jam nut and turning center screw clockwise to increase pressure, or counter-clockwise to decrease pressure.
5. Repeat steps 3 and 4 until correct pressure is achieved. Tighten jam nut and re-check pressure.

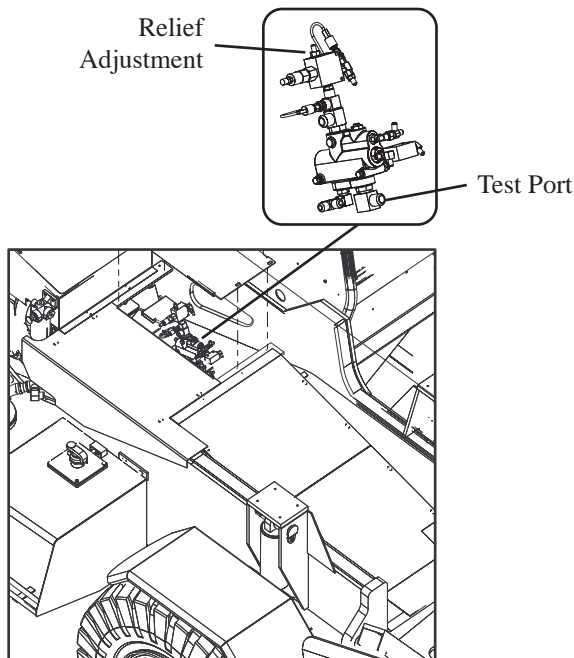

Priority Valve Pressure Adjustment

5.3-4 Pilot Pressure

1. Locate the pressure reducing valve PRV1.
2. Connect a pressure gauge (500 psi minimum) to test port TP6 at the pressure reducing valve by removing acorn nut and brass sealing washer, loosening jam nut and turning center screw clockwise to increase pressure, or counter-clockwise to decrease pressure. When correct pressure is obtained, tighten jam nut and install acorn nut with brass sealing washer.

5.3-5 Check Brake Accumulators

1. Actuate brake pedal until very little pedal resistance is felt.
2. Start engine, brake pressure light on the dash should come on. The engine should have a slight labouring sound. After idling for 30 seconds, the light should go out and there should be a noticeable difference in engine sound when it stops labouring. Accumulators should now be charged and the brake pressure light on the dash should now be off.
3. Depress the brake pedal 2 to 3 times and you should hear the engine again begin to labour for 10 to 15 seconds. The brake charge cycle should occur somewhere in the range between 30 seconds to 5 minutes and more often when brakes or pilot operated functions are used.
4. Turn off engine.
5. Turn ignition key to on position only (do not restart engine).
6. Depress brake pedal and release, repeating the process.

NOTE

- Keep count of the number of times the pedal is depressed.
- After 5 to 6 depressions, the brake pressure light should come on.
- It may take over 20 depressions to completely discharge accumulators

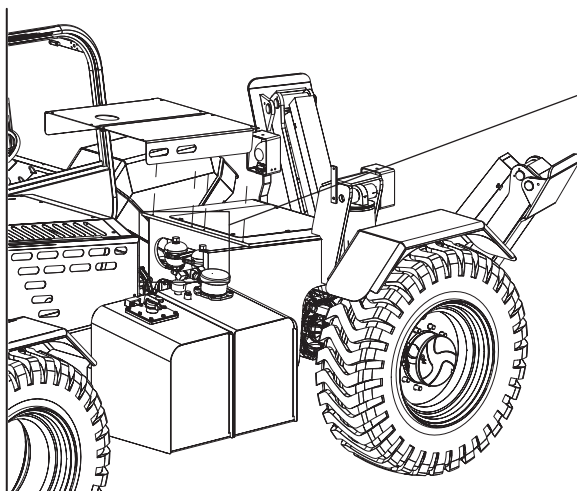

5.3-6 Charging Brake Accumulators



WARNING

Never try to check accumulators with a tire gauge type tester as it will cause a loss of nitrogen gas; which is very cold when discharged.

1. Ensure engine is turned off and depress brake pedal 10 to 12 times to empty accumulators of any oil pressure.
2. Attach proper gauge and nitrogen charge kit.
3. Charge accumulators to 650 psi.

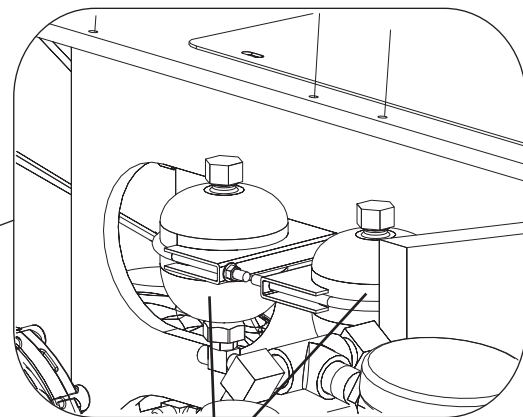

Brake
Accumulators

5.3-7 Charging Rear Axle Lock System



DANGER

- Frame leveling should not be attempted when boom is elevated.
- Boom should be in travel position (24" off the ground).
- Very unstable conditions will result if frame leveling is attempted when rear axle is in the lock position.

NOTE

The accumulator is pre-charged with nitrogen gas to 175 psi.

1. Connect the ends of 2 test hoses supplied with telehandler to the quick disconnect ports at the main valve (Frame level section) and the other ends to the rear axle lock valve ports. (See picture below).
2. Remove the ground cable or the limit switch cable connections
3. Actuate the frame level control valve to tilt the frame from side to side while holding the valve open at end of each cycle for several seconds to fully pressurize the system. This will help eliminate any air in the system.
4. Repeat step 3 four times.
5. Tilt the frame fully to the right.
6. Two of the solenoids in the rear solenoid-mounting block have manual unlocking capabilities. These are unlocked by pulling up on the knob and turning 90° so the point sits on top of the "V" stem. This position allows free flow through the lock valve for charging and will also equalize the pressure between the rod and the base ends of the axle lock cylinder.
7. Relieve the pressure on the axle lock valve by moving the rear joystick controller from left to right 4 to 5 times.
8. Remove the quick disconnect hoses at both ends and leave in frame.
9. The two manual solenoid overrides should now be returned to their closed position.
10. Check system for proper operation by attempting to level frame to the left until the left wheel starts to lift off the ground. Level frame fully to the right.
11. Attach ground cable or limit switch cable connections.
12. Cycle frame level from left to right. (Rear axle cylinder should stroke fully in both directions).

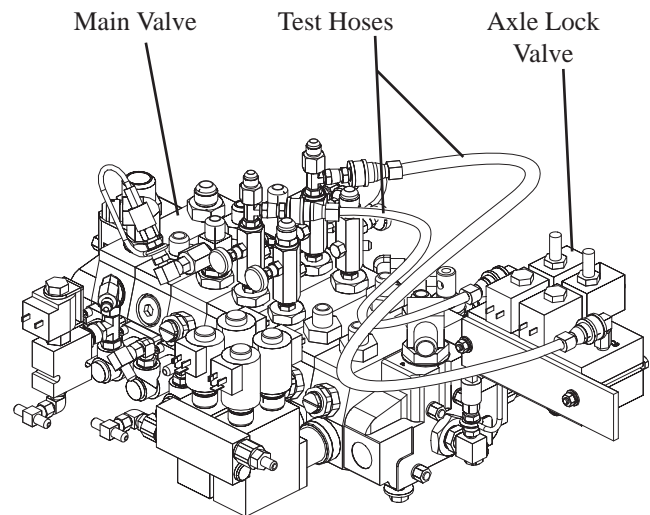

*Charging Rear Axle
Lock System*

Boom

5.4-1 Boom Hose Replacement

IMPORTANT

If there is evidence of a fluid leak in the boom sections, check first to make sure there are no loose hydraulic fittings before attempting to change the hoses in the boom.

NOTE

The hydraulic hoses inside the boom (carriage tilt, optional hydraulics) are stretched over the roller to prevent sagging and premature wear. Use only the size, spec. and length of hose as specified in the parts manual.

1. Loosen chain adjusting nut to end of adjuster.

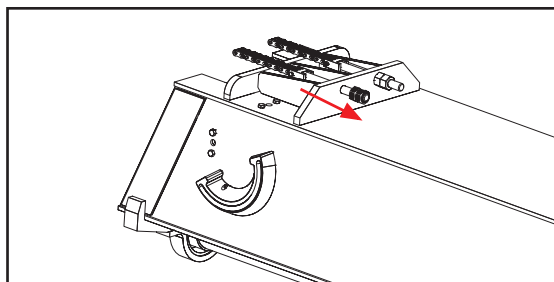

2. Extend boom just enough to allow removal of side access plates on secondary section. Then retract slightly to put slack in extend chains

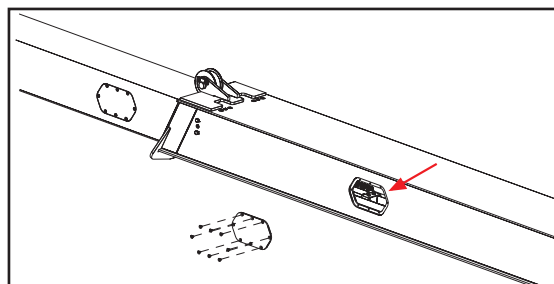

3. With side access plate off, tie a rope around tensioning bracket, loosen hydraulic fittings of hose to be replaced and remove bolts holding bracket to boom.

4. Remove hose from bulkhead on main boom section (bottom of boom) and attach new hose to old hose with a short union.
5. Remove hose from bulkhead on tension bracket and pull hose through front of boom taking care not to pull too far and lose hose inside bottom of boom. It may be necessary to either temporarily remove roller or raise primary section at the rear to get the fittings around the roller.

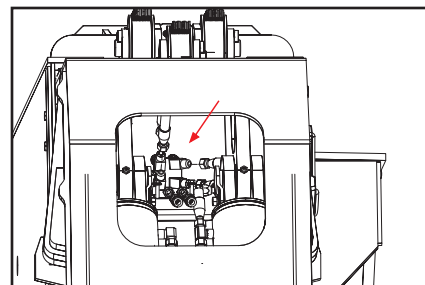

6. Attach new hose at both ends and leave loose.
7. Pull rope attached to tension bracket and bolt bracket to boom.
8. Extend and retract boom several times.
9. Tighten hose fittings 38-42 ft. lb (52-58 Nm) taking care not to twist hose.
10. Install access plate, tension chain, and bleed hydraulic circuit (refer to [Section 5.2-4](#) of this manual).

5.4-2 Boom Chain Replacement and Adjustment

Extend Chain

1. With boom level loosen extend chain adjustment nut until nut is at the end of the adjuster.

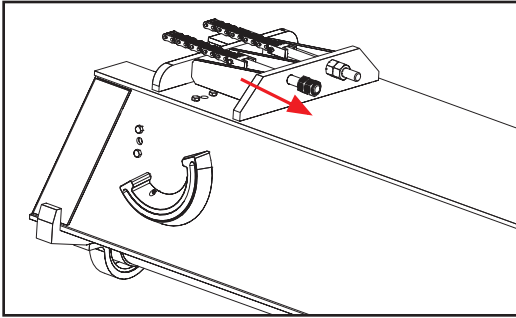

2. Extend boom 8".
3. Retract boom just enough to put slack in extend chain.
4. Remove access door at rear of boom and remove center bracket.
5. Remove two bolts holding extend chain anchor to primary boom section.
6. Remove bolt that attaches extend chain to adjuster.

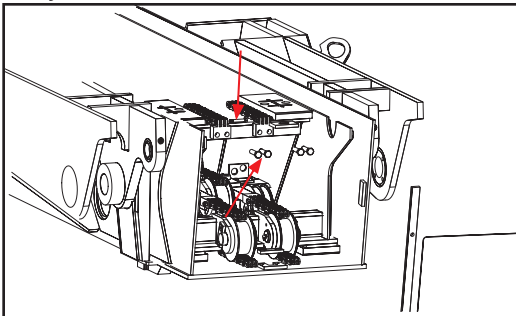

7. Attach new chain to existing chain and pull through.
8. Pull the rest of the chain through and disconnect old chain from new.
9. Remove chain anchor from old chain and install on new chain with new 5/16" grade 8 bolt and lock nut.
10. Attach chain anchor to primary boom section with 2 new grade 8 bolts.

Retract Chain

1. With boom level and retracted remove retract chain anchor nut through access hole at rear bottom sides of boom.
2. With adjustment nut loose extend boom slightly and secure secondary from moving out.
3. Remove retract chain anchor bolt at rear where anchor attaches to secondary boom.

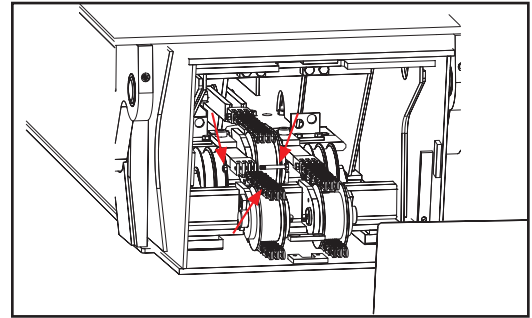

4. Extend boom enough to allow removal of retract chain anchor from main boom section.
5. Remove rear anchor from chain and attach new chain to existing chain and anchor to new chain.
6. Remove retract chain anchor from main boom section at front of boom and pull through
7. Disconnect old chain from new chain and attach anchor from old chain onto new chain
8. Bolt front anchor to main boom section
9. Attach chain anchor to secondary section at rear of boom. It may be necessary to retract boom and manually, via ratchet strap, retract secondary section

Chain Adjustment

1. Fully extend boom when level
2. Retract boom a few inches and tighten adjustment nut on top of main boom until there is no droop in chain
3. Repeat above step until there is 1/2" droop while retracting boom from full extension

5.4-3 Check Slide Pads

1. With telehandler parked on a level surface and park brake applied remove access door at rear of boom.
2. Measure slide pad thickness (top and bottom of each boom section) inside rear of boom.
3. Raise boom slightly and extend boom approximately 6' (2M). Measure slide pad thickness (top, bottom and sides of each boom section) at front end of boom.
4. Replace any pads that are less than 3/4" (19mm) thick.
5. Shim all slide pads as required. (more than 1/8" or 3mm gap)

5.4-4 Replacing and Shimming Slide Pads

1. With machine parked on a level surface and park brake applied remove access door at rear of boom.
2. Remove grease fittings and bolts of slide pads to be shimmed/replaced. (Do not use heat)

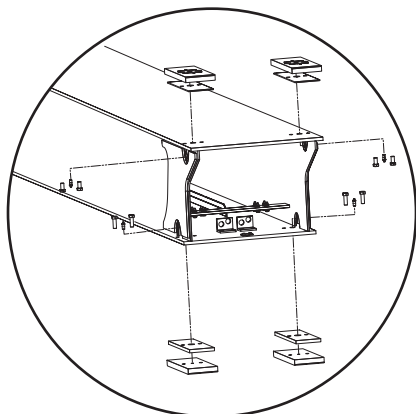

3. Add shims as required to obtain 0-1/16" (0-1.5mm) clearance with no drag.
4. Apply Loctite® 609 to bolts and torque to 100 ft.lb. Re-torque after 10min. and within 15min. of initial torque.
5. Raise boom slightly and extend boom approximately 6 ft. (2M).
6. Use steps 2 through 4 for slide pads at the front of boom. To remove side front slide pads pry boom section away from slide pad and place a support/hook under pad then remove bolts and pads.

NOTE

Always maintain squareness between the booms outer and inner tube.

Axles

5.5-1 Change Oil in Axles

1. Ensure telehandler is on a firm level surface and is in stowed position.
2. Turn off engine.
3. Place suitable container under the axle
4. Remove fill plug.
5. Remove drain plug to allow oil to drain into container.
6. Reinstall all drain plugs.
7. Remove check plug.
8. Refill axle with new oil as per specifications. (refer to [Table 2.2](#))

NOTE

Axle is filled when oil is leaking from the check port.

9. Reinstall both fill and check plugs.

5.5-2 Check Oil Level in Torque Hub

1. Drive the telehandler to rotate the hub until the plug is located at 90 degrees.
2. Remove the plug and check the oil level. The oil level should be even with the bottom of the plug hole. Add oil if needed. (refer to [Table 2.2](#) for oil specifications)

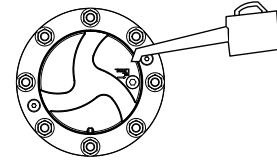

Drive Torque Hub

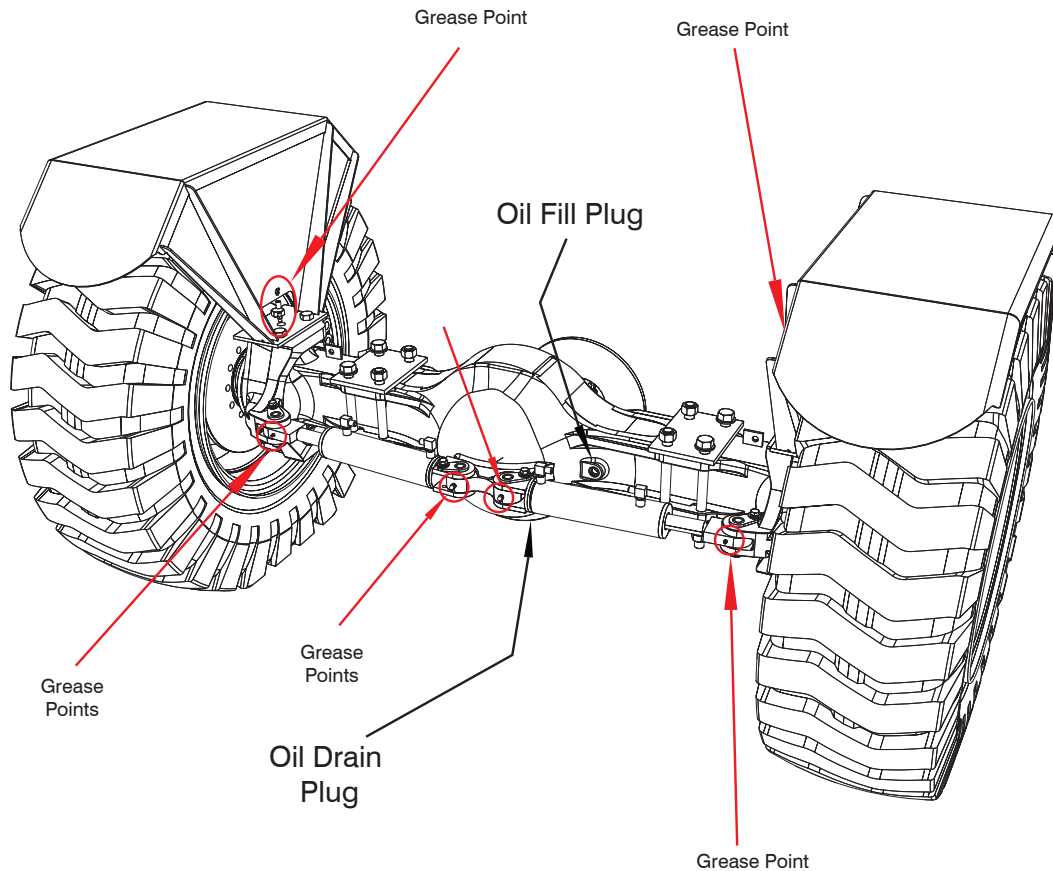

Front or Rear Axle

Grease Points

NOTE

Brush-on dry lubricant may be applied in the field where greasing is undesirable. This may be the case in extremely sandy conditions, where abrasive particles can become entrapped in the grease. (refer to [Table 2.2](#) for recommended grease and fluid types and greasing intervals).

5.6-1 Frame Grease Points

Add grease to the following components. Ensure grease reaches the bearing internals.

- Brake pedal pivot pin
- Lift cylinders
- Axle lock cylinder
- Frame level cylinder
- Slave cylinders
- Outrigger pins

NOTE

When greasing cylinders, pump grease into grease fittings located on both the base end and the rod end of the cylinder.

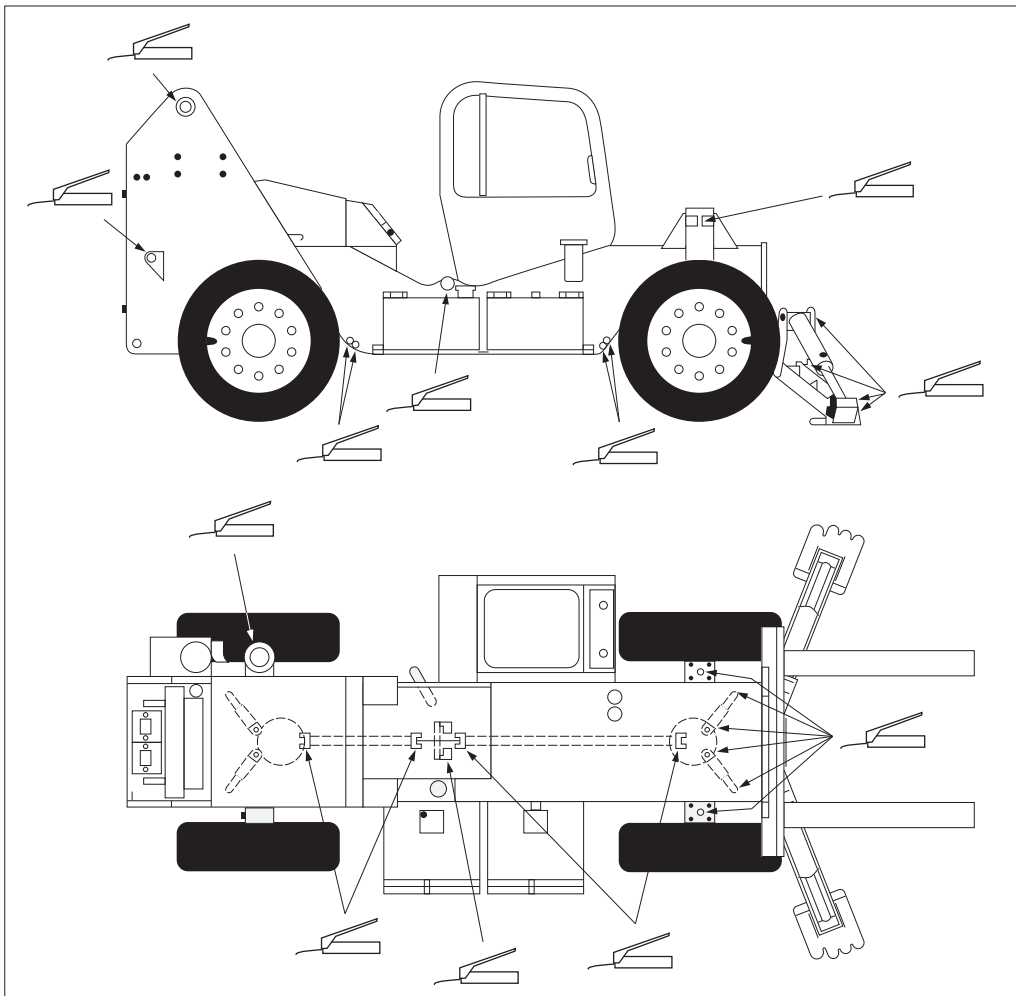

Frame Grease Points

5.6-2 Boom Grease Points

NOTE

Grease should be applied if any of the following occur:

- Pulsating or erratic boom operation, especially on retract.
- Appreciable loading of the hydraulic system also while retracting the boom in the horizontal position, or
- Noticeable wear of the high-load flange surfaces of the boom

Add grease to the following components. Ensure grease reaches the bearing internals.

- Main boom pivot bearings
- Carriage tilt cylinders
- Carriage pivot bearings
- Extension chain rollers
- High load slide pads *
- Retract chain roller
- Hose rollers
- Oil extension chain

Extend boom and rest it on the ground. Wipe the exposed portion of the extension chain with oil.

* Lubricate the rear top pads (4 places) on the primary and secondary booms through the door at the rear of the boom while the boom is fully retracted.

Lubricate the front bottom pads (4 places) on the main and primary booms while the boom is also fully retracted.

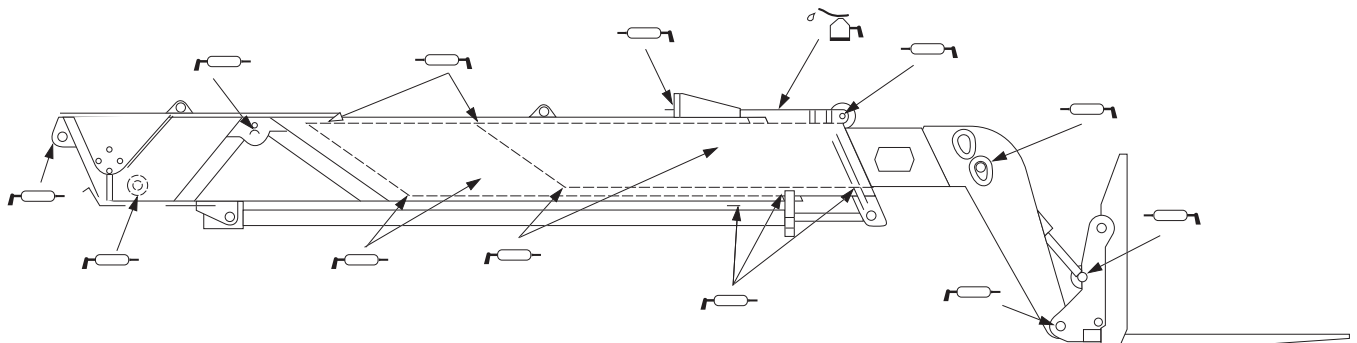

Boom Grease Points

5.6-3 Drive Axle Grease Points

1. Ensure telehandler is on a firm level surface and is in stowed position.
2. Open axle cover plate and locate grease fitting. (See diagram below)
3. Pump grease into the grease fittings.

5.6-4 Drive Shaft Grease Points

1. Locate the grease fittings on the drive shaft and pump grease. (See diagram below)

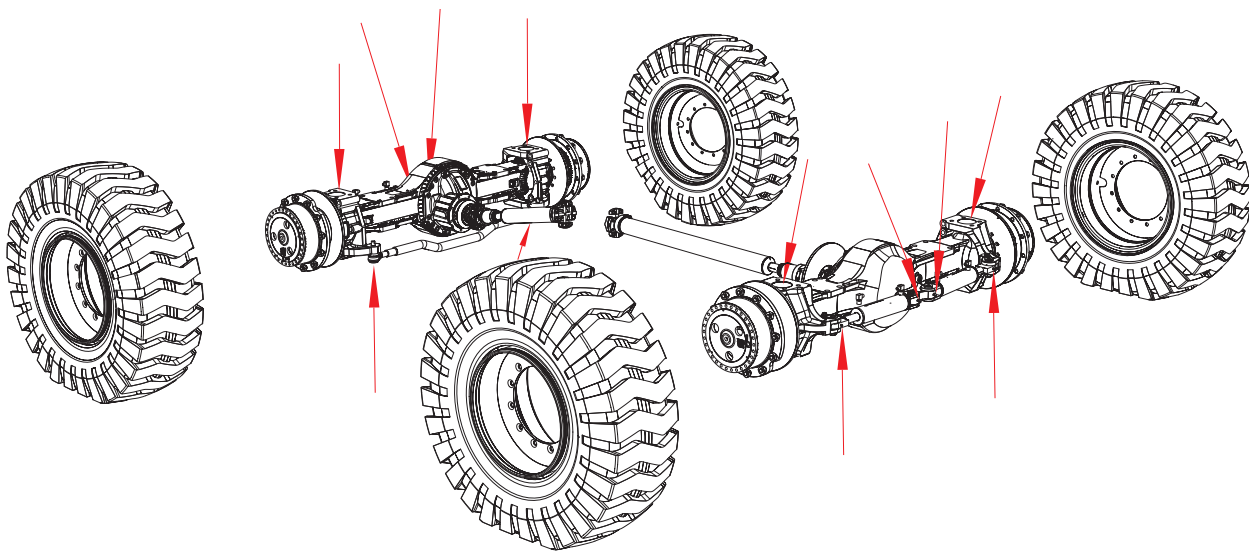

Axles & Drive Shafts Grease Points

Tires

5.7-1 Check Lug Nut Torque

1. Tighten wheel nuts to an initial torque reading of 50-100 ft-lbs, dry, in the sequence shown below.

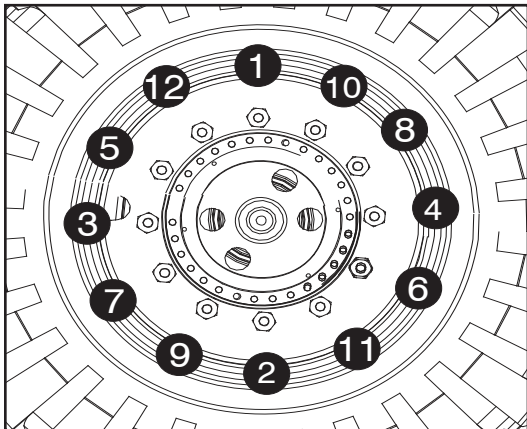

2. Re-tighten wheel nuts to a torque of 450-500 ft-lbs, dry, in the sequence shown above.
3. When the wheels are removed and reinstalled, check the nuts after eight (8) hours of operation.
4. If nuts are tight after the eight hour check, the interval for checking with a torque wrench can be extended to 250 hours.



Reliable lift solutions by people who care.

www.skyjack.com