

MK 100/110 mobile construction crane



Lifting capacity (max.):	8,000 kg
Reach (max.):	52.0 m
Lifting capacity at jib head:	1,800 kg



LIEBHERR

MK 100/110 mobile construction crane

max. 52.0 m radius
max. 68.0 m hook height

15°, 30° and 45° luffed jib positions as standard
- and even with the tower retracted

SPEED 2 LIFT
Pure 2-line operation for
maximum handling performance

Horizontal load path for top handling performance

Highly efficient construction site lighting

Telescopic tower
2 hook heights as standard

Steplessly height-adjustable lift cab
for best possible view of the site

MICROMOVE
Fine positioning with millimetric
precision at the push of a button

Economical low-noise Diesel generator
with low exhaust gas emissions

Efficient, fine sensitivity FC high-performance drives

**Driver's cab with maximum
convenience layout**
with unobstructed view of the road

**5 steering programs with
active rear-axle steering**

2 support base widths

Table of contents

Versatility of operation – that means economy	Pages	4 - 9
Your success is our drive	Pages	10 - 13
Get right where you want	Pages	14 - 17
Simply a good arrangement	Pages	18 - 21
Work fast – work safely	Pages	22 - 25
Excellently equipped	Pages	26 - 29
More than just the crane	Pages	30 - 31
Technical data	Pages	32 - 34
So many uses – an overview	Page	35

Versatility of operation – that means economy



Just some of the possible operational situations

- Inner city and night-time sites
- Timber, steel, and hall construction
- Refineries and chemical plants
- Antenna construction
- Roof refurbishment and greenery
- Placement of solar panels
- Window and facade construction
- High-level storage bay units
- Bridge and highway construction
- Maintenance and repair work
- Prefabricated component and prefabricated building construction
- Demolition and installation work
- Site preparation work
- and much more besides.

Liebherr mobile construction cranes – so many advantages

Operation with interfering edges: The vertical tower allows for Liebherr mobile construction cranes to be erected and operated directly at the building. Take advantage of the full jib length, with high lifting performance at maximum radius.

Taxi crane concept: High mobility without any major logistical effort needed – arrive, lift, move on, without any extra transport involved.

Incredible manoeuvrability: Thanks to the active rear axle steering, Liebherr mobile construction cranes can slip into any gap between buildings.

One-man operation: Transport, erection, and the entire operation of the crane – and only one person required. No need for expensive extra transport or additional erection and assembly personnel.

Small space requirement: When things get tight - that's when the mobile construction crane really shows off its strengths. The crane needs only a very small amount of space for erection and operation.



Versatility of operation - that means economy

- Large outreach thanks to horizontal jib
- Flexible jib settings and impressive hook heights
- Several operational engagements per day – no problem at all
- One-man operation – no extra equipment needed

Versatility of operation - that means economy



Turn night into day

Thanks to the quiet, low-emission electrical drive units, the MK 100/110 is ideally suited for night-time operations in inner-city situations.

And thanks to the lighting system integrated in the jib, the area of operations is excellently illuminated.



Half height with full load capacity

In areas with restricted height clearances, or under high-voltage cables, the MK 100/110 can still be used with full outreach and full lifting capacity.



Autonomous operation

The Diesel generator is economical, but very powerful too, and that makes the mobile crane independent in operation, with low noise, and minimal effect on the environment. Operation with the site power supply is possible as well. And there's enough electrical energy to power other consuming components as well.



Arrive, lift, move on

With the taxi crane concept, you can handle multiple operations in a single day.

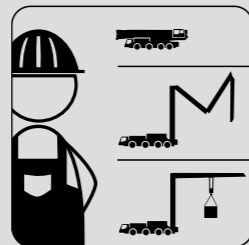

One man, one crane

No need for extra personnel or extra transport.

Get in close

The crane can be positioned directly at the building itself.

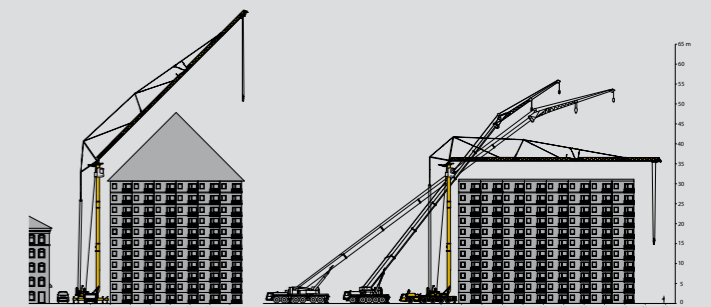



Your success is our drive

- Powerful and economical drive concept
- FC high-performance drives are emission-free and very environmentally friendly
- Quiet, economical operation with the site power supply or integrated Diesel generator
- Even safer operation with intelligent PLC programmable control system

Your success is our drive

The high-performance electric drives developed and manufactured by Liebherr are specially matched to the requirements of crane operation. The integrated Diesel generator in the superstructure makes completely independent operation possible, while the engine in the undercarriage is not needed for erection and site operations. This saves you fuel and helps safeguard the environment.



Integrated Diesel generator

The compact and powerful generator, producing 48 kVA, provides current for the electric drives and, if necessary, for other machinery as well. The Diesel engine always runs in the optimum range, which makes it extremely economical in consumption.



Stepless FC high-performance drives

Liebherr high-performance drives produce no emissions, provide fine sensitivity and precision, use little current, and at the same time are particularly high performers. The slewing gear can be adjusted to suit the needs of the crane driver.

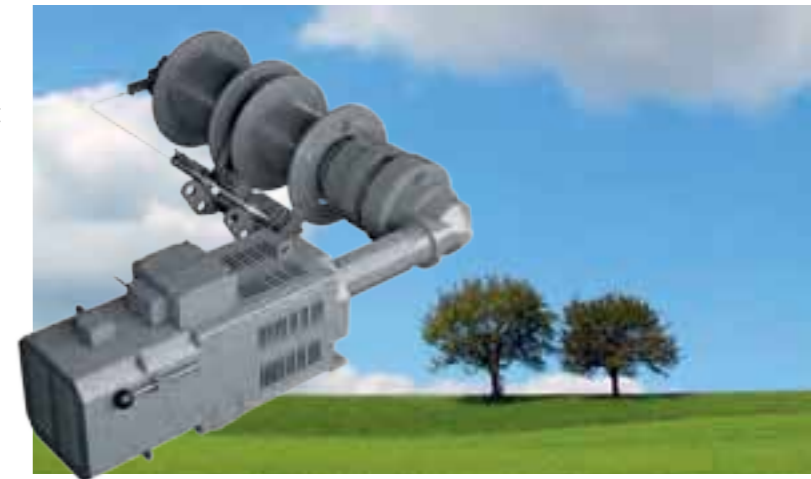

Programmable controller system - PLC

Easier and more convenient operation, greater safety in erection and operation. Features such as work area limitation, load moment limitation, or lowering level limitation, all contribute to even safer crane operation. And Teleservice increases crane availability.



Quiet

Low noise emission for night-time working or in noise-sensitive locations.

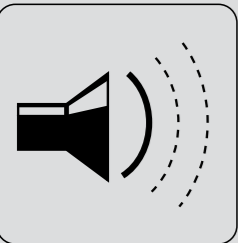

Horizontal load path

The horizontal movement of the load means that high working speeds can be reached, which means high handling performance.

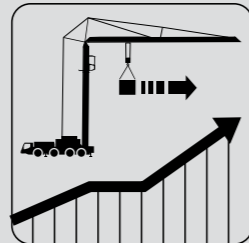

Distribute electric power

Power takeoff connections provide current for other machinery as well.



Easy overview

Easy crane operation, easy overview, and rapid information for the driver.





Get right where you want

- See a lot and drive safely – unobstructed view of the road
- Five steering programs with active rear axle steering for maximum mobility
- High ground clearance for difficult offroad conditions
- Very latest undercarriage technology available

Get right where you want

Unobstructed view

A good view is essential for being safe on the road and on site as well. With mobile construction cranes from Liebherr there is nothing to obstruct the view. Short projections and compact transport dimensions mean safe arrival at the destination. The modern cab is ergonomically designed and provides the driver with maximum comfort even on long journeys.



Mobility off the road as well

The high ground clearance and the modern drive concept mean safe driving even under difficult off-road conditions.



Engine capacity

A powerful 6-cylinder turbo-Diesel engine from Liebherr, producing 370 kW (503 h.p.) guarantees top drive performance. The 12-speed ZF transmission with the AS-TRONIC automated gear change system makes operation even more economical and driving even more convenient.



Really manoeuvrable

The turning radius is only 11.28 metres, which means that the MK 100/110 needs less room to manoeuvre than a conventional mid-range vehicle. And with the five steering programs you are best equipped to deal with any situation.

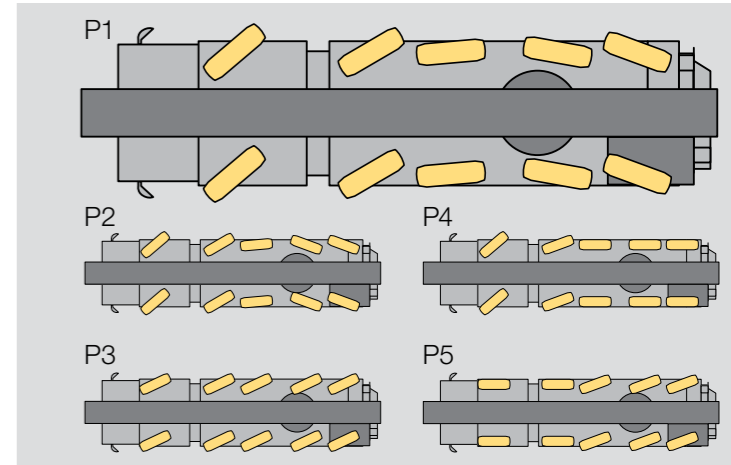

- P1 Road steering
- P2 All-wheel steering
- P3 Crab steering
- P4 Reduced swing-out
- P5 Independent rear-axle steering



Tyres

Tyres size 14.00 R 25 ensures low wear and high traction.



Intarder

Wear-free braking with standard Intarder.

Reversing camera

Safe manoeuvring on the construction site.





Simply a good arrangement

- Small space requirement thanks to high jib erection in the air
- Highly adaptable thanks to two different set-up curves
- Erected complete in 17 minutes from the supported state
- Safety-monitored erection by one man alone

Simply a good arrangement



The crane can be moved and rotated by 360° during erection. Combined with the different set-up curves, this makes the MK 100/110 extraordinarily adaptable. The program-controlled erection procedure provides the greatest possible degree of safety. The crane driver can intervene at any time and change the speed and direction of erection. And for engagements lasting several days there is no need for disassembly, with the crane being allowed to weathervane.

Wireless movement

Radio remote control with check-back allows for all the erection and operational functions of the MK 100/MK 110 to be carried out. The crane driver has all the information needed, at his fingertips. Crane, site, and load are always in view.



Flexible support

The standard support width is 8.2 metres and can be reduced to 5.95 metres if required – and still with low corner pressures.



Safe

The slewing radius remains within the supports. No parts of the crane overlap the outriggers on the ground – an essential advantage when it comes to operational safety.

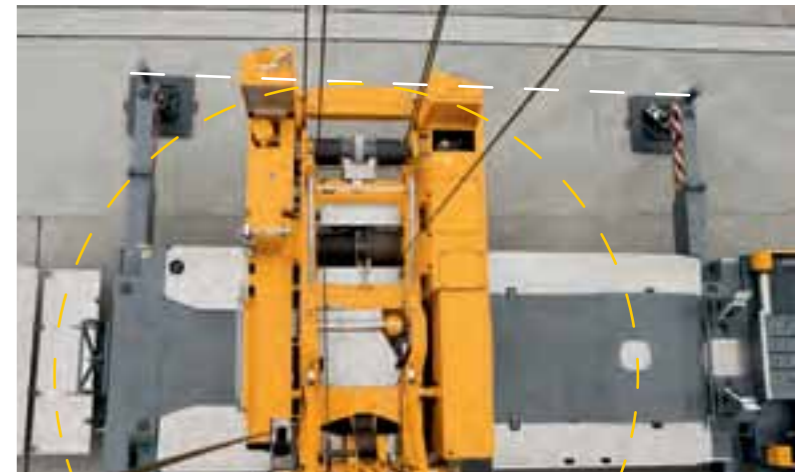

Rapid erection

Ready for operation in only 17 minutes from the supported state.

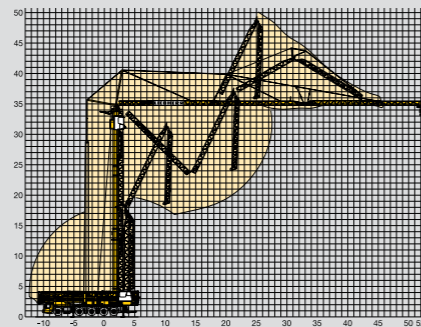

Genuine jib erection in the air

Can be erected even over obstacles up to 17 metres high.

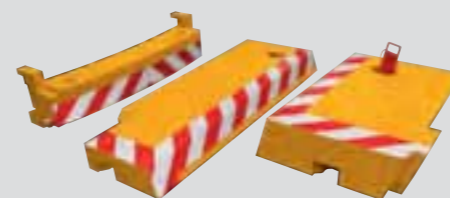

Additional ballast

With an additional ballast of 3.8 t, the MK 110 has a lifting capacity of 1,800 kg at the jib head.

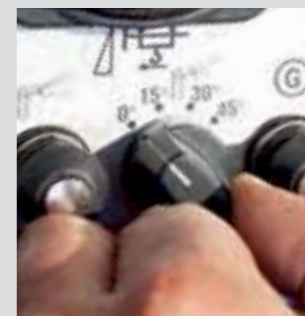

Simply flexible

Erection switch for the 0°, 15°, 30°, 45° jib positions.



Work fast – work safely

- No problem with working around interfering edges: Make full use of the whole outreach
- SPEED 2 LIFT: Pure 2-line operation
- MICROMOVE: Fine positioning with millimetric precision
- Everything in view: Steplessly height-adjustable lift cab

Work fast – work safely

Cabin on a level with the load

With the steplessly height-adjustable lift cab, you have the load and the site in your sight at all times, which means that the crane driver maintains best possible eye contact with the assembly personnel. This increases safety enormously.



Keep the load calm

With the wind load control the jib is automatically held in place if the wind gets up. No need to counter-steer. This means that loads which present large surface areas (such as formwork panels) can be moved, held, and positioned with absolute precision. Rapid slewing movements can lead to loads starting to swing; the integrated load oscillation damping compensates for this automatically.

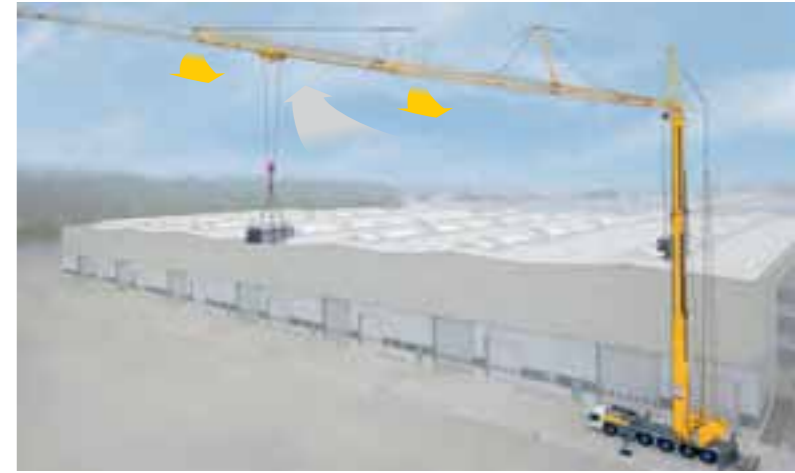

Position loads with millimetric precision

At the press of a button on the control lever, MICROMOVE comes into action, and reduces lowering to micro-speed. This means that even the heaviest loads can be floated, held, and positioned with extremely fine sensitivity, and without engaging the hoist gear brake.

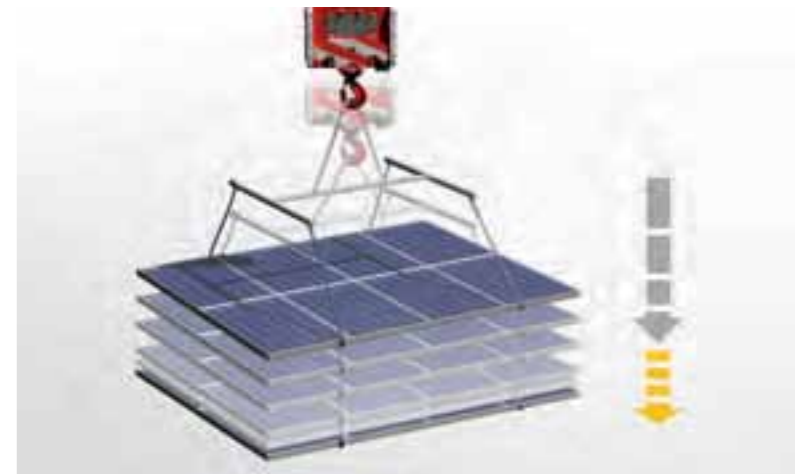

Information

With the EMS electronic monitor system in the lift cab of the crane, the driver has all the crane functions fully in view.

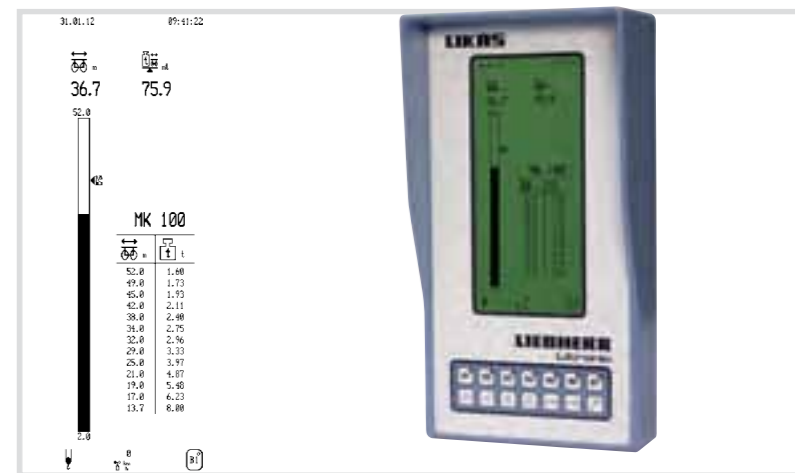

SPEED 2 LIFT

Pure 2-line operation for maximum performance at full speed.

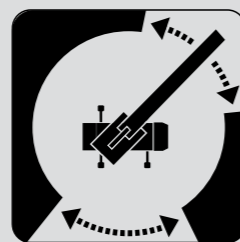

Operating-range limiting system

Limits to work areas are set by simple teach-in techniques on the EMS display – more safety for everyone.

Mobile – and everything in view

The radio remote control with check-back shows all the operational data on a easily readable display.



Excellently equipped



The lift cab

The steplessly height adjustable lift cab is fitted with safety glass all round, and is one of the main features of the mobile construction crane. It includes a comfortable heated seat with armrest control, including integrated master switches, an EMS electronic monitor system, and a radio/CD player.

Everything in view

The lift cab provides a perfect view of the load and the site, at any height. With the EMS and the trolley camera, you have all the information needed, at a glance. And that means fatigue-free and efficient working – guaranteed, day in, day out.



Good access

The safe and easy entry to the cab guarantees the safety of the crane driver. Cumbersome climbing is not necessary.



Mattresses always where they're needed

Tough, strong strut plates made of top quality materials are easy to access in the stowage compartments provided, with pull-out shelf elements.



And a light comes on

A site lighting system integrated into the jib makes it possible to work even after dark.



Access

The integrated ladder provides the driver with safe access to the slewing platform and the lift cab.



Simple levelling

Easy operation and easy overview of the undercarriage supports.



Easy to work means efficient work

All operating elements are arranged ergonomically and designed for easy overview.

Excellently equipped



Trolley camera

Thanks to autofocus and zoom, the load is constantly in view on the screen in the lift cab. The batteries are charged automatically, which means that the camera system is always available.



Tool / stowage locker

The spacious locker has plenty of room for personal items and tools.



Climate control system

The climate control system on the lift cab ensures that the cab always has pleasantly fresh air, even when the temperature outside gets high.



Hand-operated spotlight

Mobile light for all situations.



Cable control console

As an alternative to remote radio control, operation is also possible by way of the cable control console.

Equipment carrier

So that you always have the most important things close at hand. The large storage space means that crane accessories can be carried safely on board. The equipment carrier is raised and lowered hydraulically, and can be tilted up when on site.



Combi-box

The Combi-box is the easy way to stow guying cables, straps, Diesel canisters, and underlay timbers, and have them immediately available whenever they are needed, protected against the weather and theft.



Safety equipment

The safety package in the lift cab means that in an emergency the crane driver can lower himself out of the cab.



Engine shutoff with Emergency Stop

Engine overspeed protection and Emergency Stop switch for the undercarriage engine and the Diesel generator.



Teleservice

Easy evaluation of the machine data and remote maintenance on the office PC, to increase the crane availability even further.

More than just a crane



There for you 24/7

We can help you at every possible time of operation. Talk to our experienced and skilled mobile construction crane specialists.

+49 7351 41-4000 (Mon.-Fri. from 8.00 – 17.00)
+49 176 178 922 48 (on-call service)

Service network

Take advantage of the universal Liebherr Service network, worldwide.



Transport

A broad network of well-known forwarding companies guarantees fast and reliable transport.

Training

Experienced instructors to provide training in theory and practice, comprehensive training resources, and a training centre with the highest technical standards, guarantee that basic and advanced training can be provided in all matters associated with the crane. Our aim is to prepare well-trained service technicians and crane drivers, who will contribute to ensuring that construction sites run smoothly, economically, and safely.

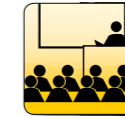

Original spare parts

Our original spare parts are ideally matched to every Liebherr crane, and meet the very highest standards with regard to quality and functional performance. And whenever our products are optimized even further, we pass the benefits on to our spare parts as well.



Service and guarantee

Consistent maintenance contributes to a long and successful service life for your crane. Repairs, maintenance, and overhaul of used machines are carried out by experts at the Liebherr repair centre.



Why mobile construction cranes from Liebherr?

Liebherr have more than 60 years experience in the construction of cranes, and provide you with development, production, and service all from one source. The unique depth of manufacturing skill, combined with features such as the in-house production of winches and electric motors, guarantees that all the components of the crane are matched perfectly to one another. Every equipment unit is a creation of top quality, with extremely long service life. And after you have bought your crane, Liebherr will always still be there to offer you best possible after-sales service with fast spare parts supply.

Technical data MK 100/110

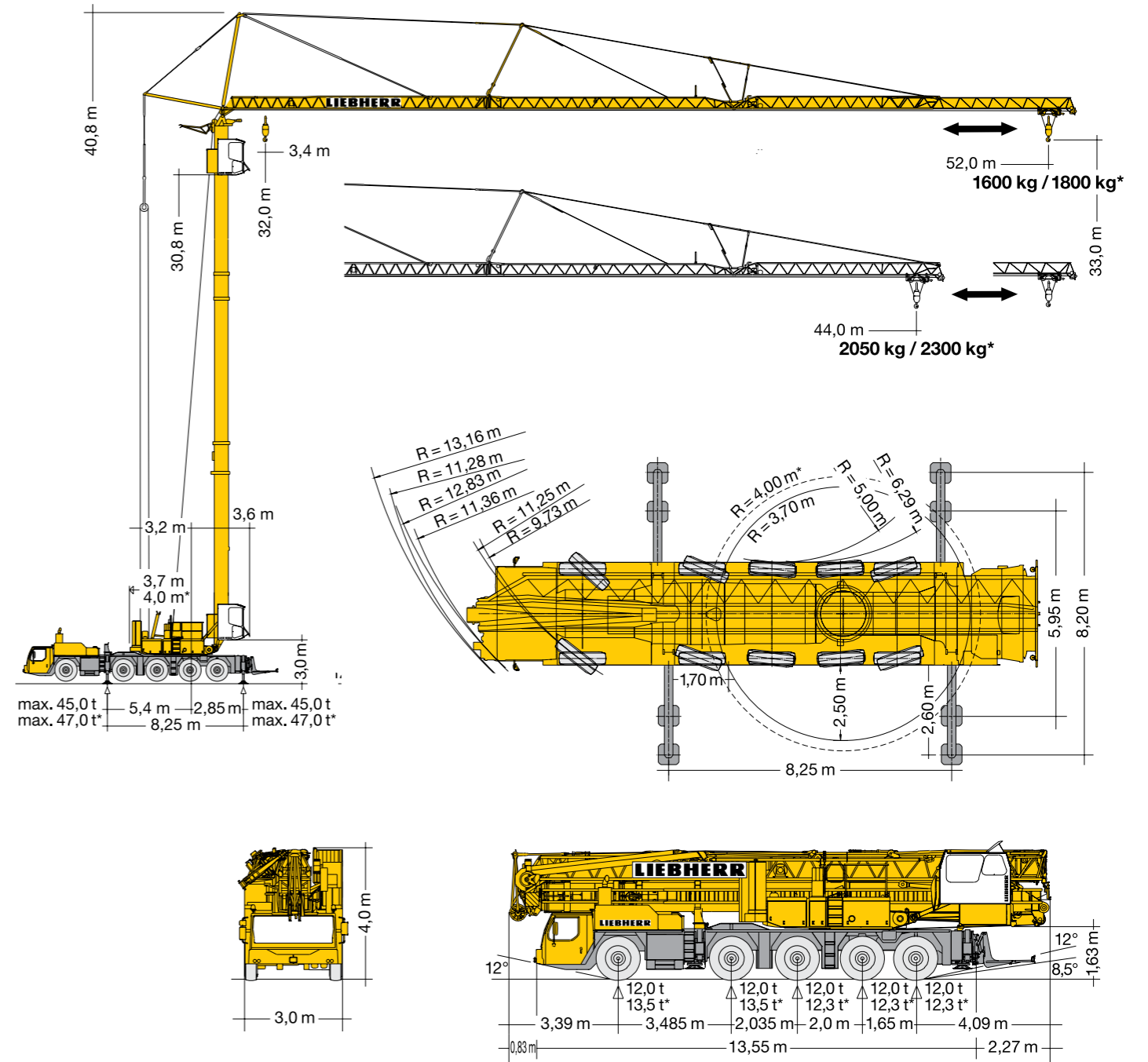
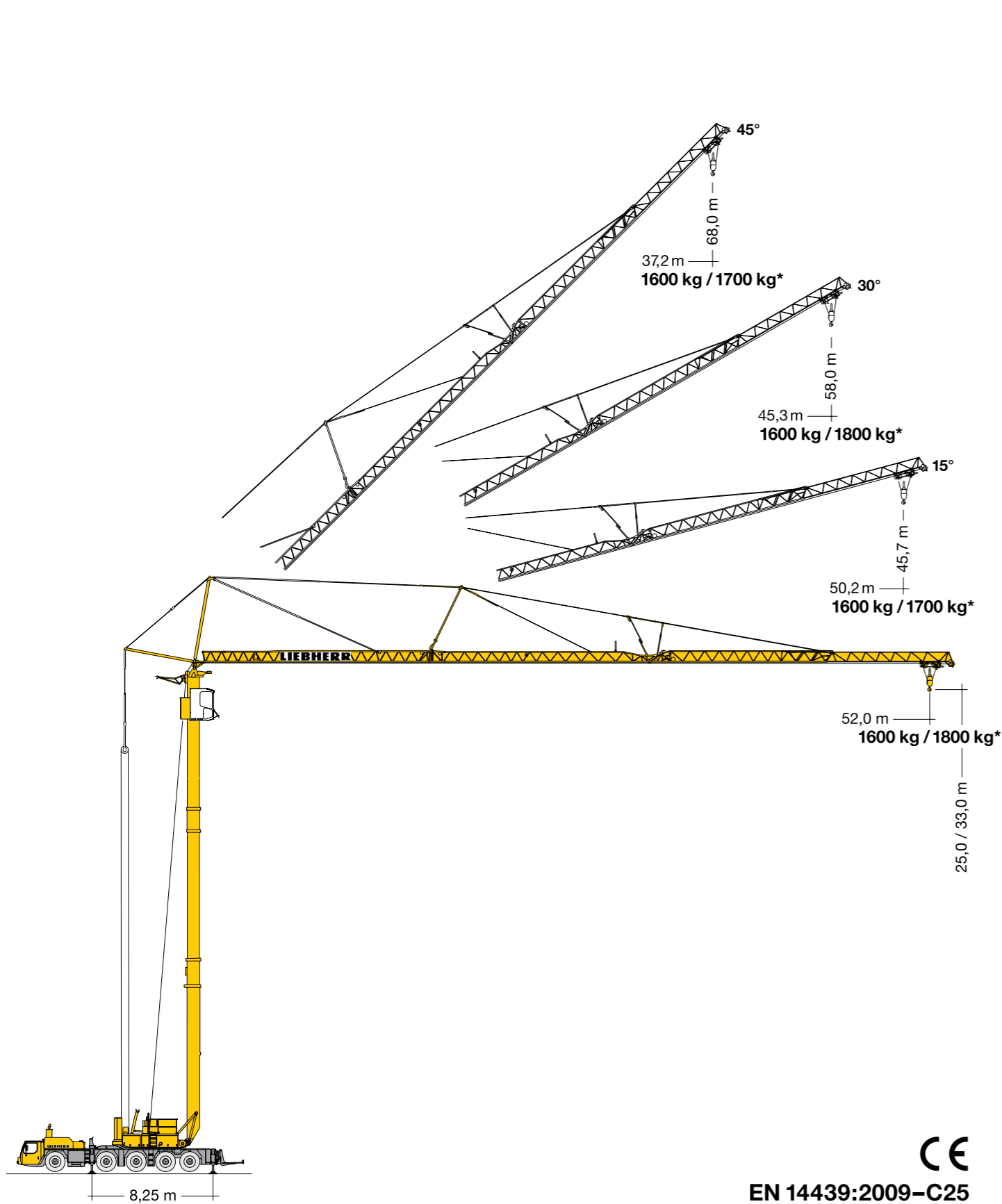

Gewicht

Weight / Poids / Peso / Peso / Gewicht / Macca



Gesamtgewicht	60 000 kg	* MK 110 mit 3,8 t Zusatzballast / MK 110 with 3.8 t additional ballast / MK 110 avec lest additionnel de 3,8 t / MK 110 con zavorra addizionale da 3,8 t / con contrapeso adicional de 3,8 t / MK 110 met 3,8 t extra ballast / с дополнительным балластом 3,8 т	60 000 kg + 3 800 kg
Total weight			
Poids total			
Peso total			
Peso total			
Totaalgewicht			
Общая масса			
		Achslasten	> 12,0 t
		Loads per axle / Charges par essieu / Carichi per asse / Peso por eje / Aslasten / Harпузка на мосты	
		Zusatzballast für Straßentransport demontieren, Ländervorschriften beachten.	
		Remove additional ballast for road transport, observe country-specific regulations.	
		Démonter le lest additionnel pour le transport sur route, respecter les spécifications des pays individuels.	
		Smontare la zavorra aggiuntiva per il trasporto su strada, rispettare le norme nazionali.	
		Desmontar contrapesos adicionales para tránsito en carretera, véase condiciones en cada país.	
		Extra ballast dient voor wegtransport gedemonteerd te worden, landvoorschriften navolgen.	
		Для транспортировки по дорогам демонтировать дополнительный балласт, учитывать предписания, действующие для данной страны.	



EN 14439:2009-C25

Technical data MK 100/110

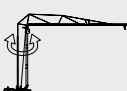
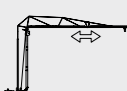
Antriebe Driving units / Mécanismes d'entraînement / Meccanismi / Mecanismos / Aandrijvingen / Приводы

	0 ↔ 0,8 U/min	7,5 kW FU
	0 ↔ 73,0 m/min	4,0 kW FU
	0–30°	2 min.

 **30,0 kW FU**
WIW 240 KY 003



↔ **stufenlos / stepless / régl. continu**
regl. progressiva / sin escalones / traploos
Бесступенчатый kg m/min

 **1** 8000 0 ↔ 19
500 0 ↔ 75

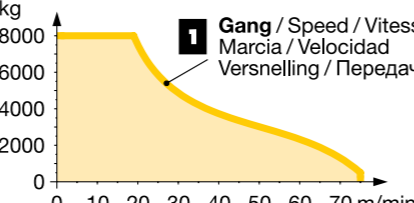
1 **Gang / Speed / Vitesse**
Marcia / Velocidad
Vernelling / Передача

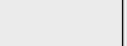

	1	2	3	4	5	6	7	8	9	10	11	12	R1	R2	 %
 (km/h)	5,2	6,7	8,6	11,1	14,0	18,0	23,7	30,5	39,2	50,4	63,9	75,0	5,6	7,2	54%
 (km/h)	2,3	3,0	3,8	5,0	6,3	8,1	10,6	13,6	17,6	22,5	28,6	36,7	2,5	3,2	> 60%

 14.00 R 25	BGL 	C.0.08.0100 C.0.08.0112*	400 V	Hz	kVA
			96,0 m 5 x 16 mm ²	50	43,0

Aufstellvorgang Erection procedure / Déroulement de montage / Procedimento di montaggio / Procedimiento de montaje / Opstelling van de mobiele torenkraan / Процесс развертывания

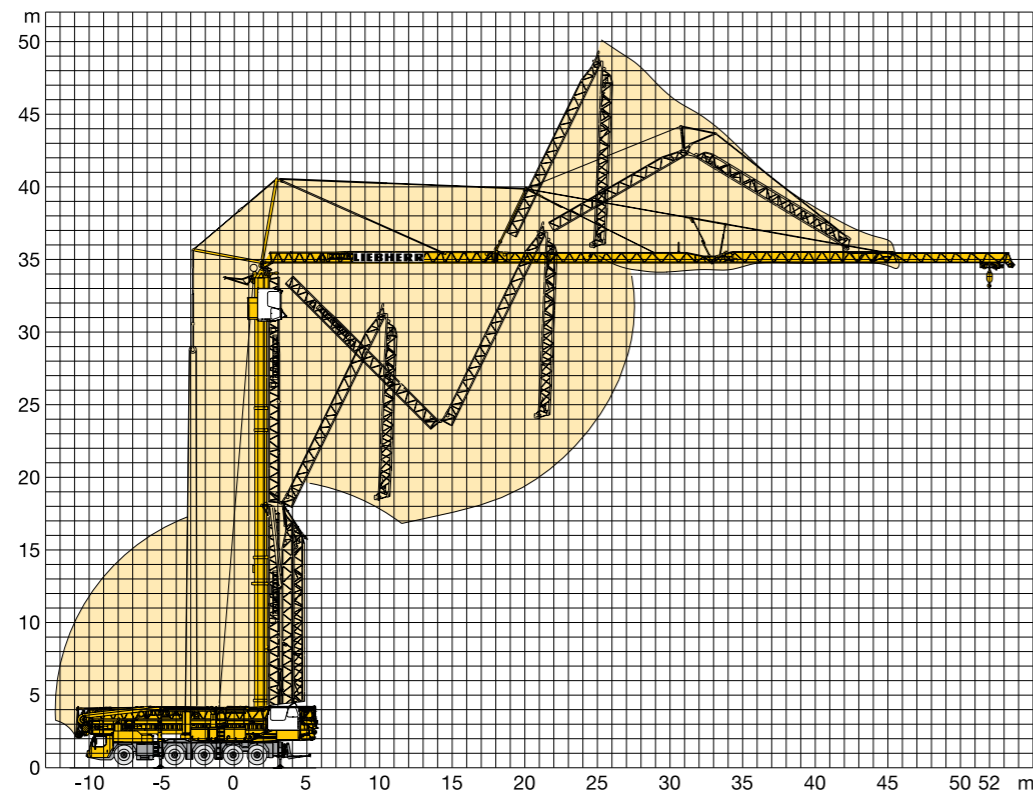

The advantages – at a glance



Pure 2-line operation

Maximum performance at full speed – always.

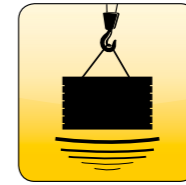

MICROMOVE

Fine positioning with millimetric precision at the push of a button.

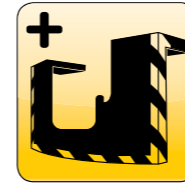

Extra ballast

for even more lifting capacity over the entire moment range.

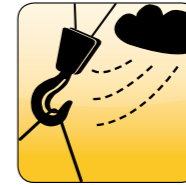

Wind load control

The control system reacts automatically to the counter-moment on the jib.

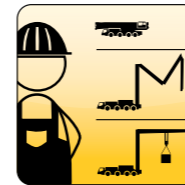

One man, one crane

No extra personnel or transport needed.



Electronic load moment limitation

Move the load safely right to the stop.



Taxi crane concept

Deal with multiple operations in one day.

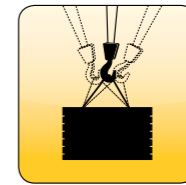

Load oscillation damping

Automatic compensation for jib movements, to keep the load steady.

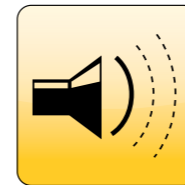

Low noise emission

for working at night or in noise-sensitive areas.



Operating-range limiting system

Work areas are limited by simple teach-in techniques on the EMS display



Ready to go into action – in only **17 minutes** from the supported state.

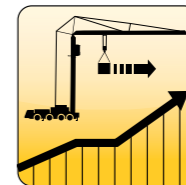

The horizontal load path of the crane allows for high working speeds, and that means high handling capacities.



Operating data acquisition and evaluation

Acquisition of all operating and performance data from the crane, for evaluation and optimum maintenance and repair.

Don't hang on...



Go for it.



Mobile Construction Crane

Let's stay in touch.

Printed in Germany by Eberl bk-Eder LBC-729-04.12_en

Subject to technical modifications.

Liebherr-Werk Biberach GmbH

Postfach 1663, D-88396 Biberach an der RiB

☎ +49 (0)7351 41-22 45, Fax +49 (0)7351 41-20 09

www.liebherr.com, E-Mail: info.mk@liebherr.com